

# GROUP 3 ELECTRIC SYSTEM

## ELECTRIC COMPONENTS MOUNTING 1

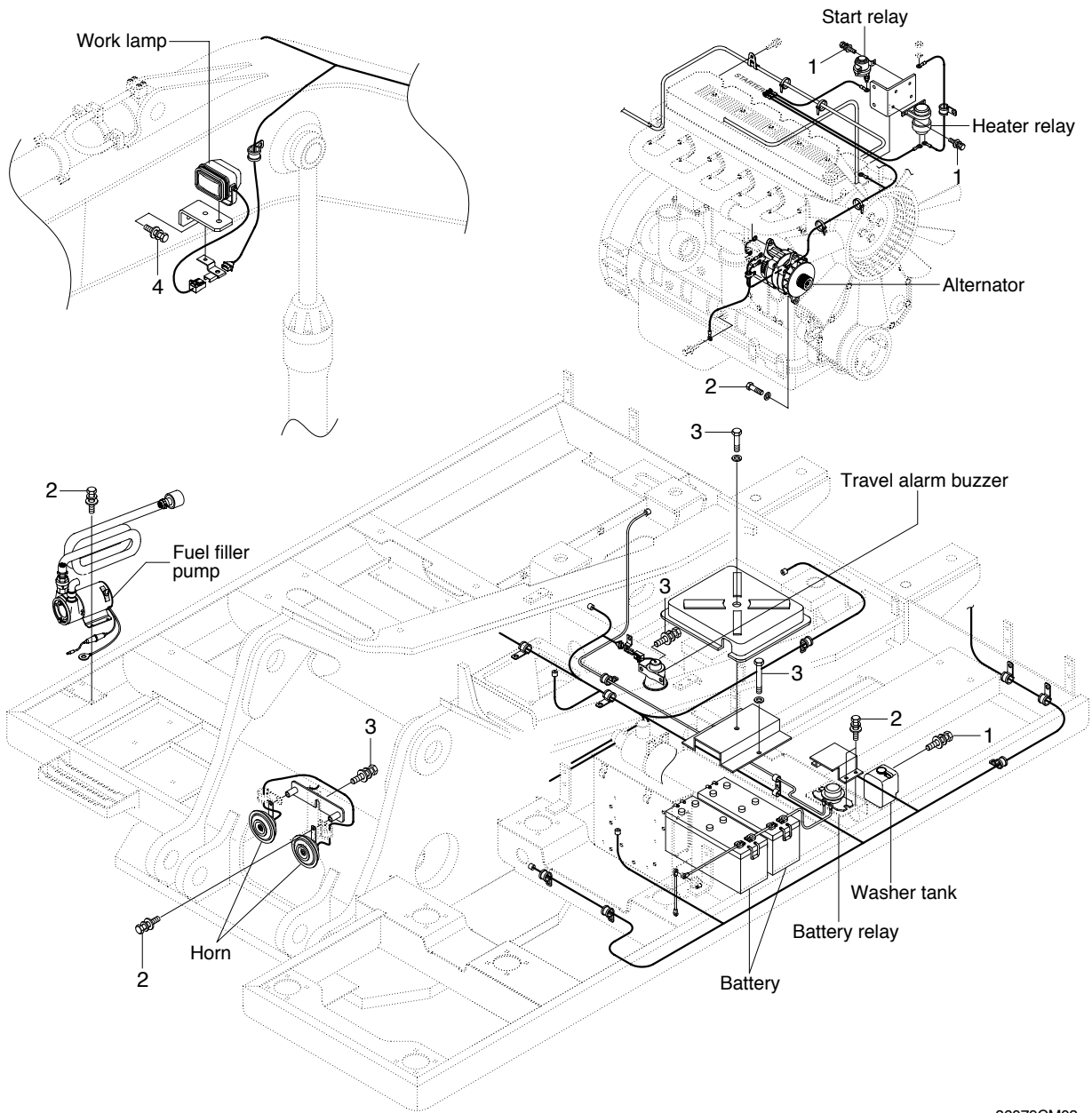

36079CM03

### · Tightening torque

Item	Size	kgf · m	lbf · ft
1	M 6 × 1.0	1.05 ± 0.2	7.6 ± 1.45
2	M 8 × 1.25	2.5 ± 0.5	18.1 ± 3.6

Item	Size	kgf · m	lbf · ft
3	M10 × 1.5	6.9 ± 1.4	49.9 ± 10.1
4	M12 × 1.75	12.8 ± 3.0	92.6 ± 21.7

## ELECTRIC COMPONENTS MOUNTING 2

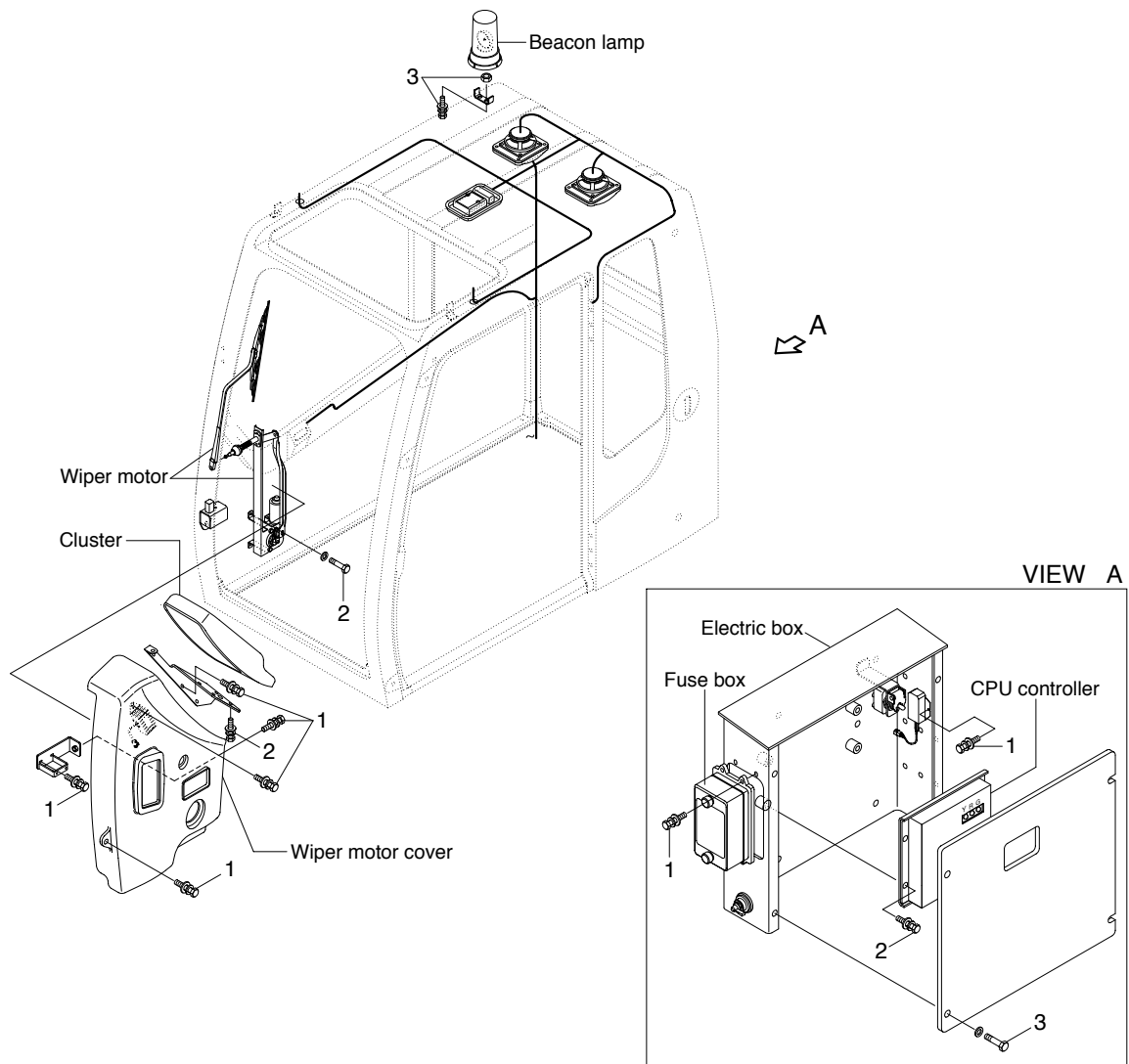

36079CM04

### · Tightening torque

Item	Size	kgf · m	lbf · ft
1	M 6 × 1.0	1.05 ± 0.2	7.6 ± 1.45
2	M 8 × 1.25	2.5 ± 0.5	18.1 ± 3.6

Item	Size	kgf · m	lbf · ft
3	M10 × 1.5	6.9 ± 1.4	49.9 ± 10.1
-	-	-	-