

GROUP 5 SWING DEVICE

1. REMOVAL AND INSTALL OF MOTOR

1) REMOVAL

- (1) Lower the work equipment to the ground and stop the engine.
- (2) Operate the control levers and pedals several times to release the remaining pressure in the hydraulic piping.
- (3) Loosen the breather slowly to release the pressure inside the hydraulic tank.

▲ Escaping fluid under pressure can penetrate the skin causing serious injury.

※ When pipes and hoses are disconnected, the oil inside the piping will flow out, so catch it in oil pan.

- (4) Disconnect hoses (2, 3, 4, 5, 6, 7, 8, 9).
- (5) Sling the swing motor assembly (1) and remove the swing motor mounting bolts (10).

·Motor device weight : 75 kg(165 lb)
 ·Tightening torque :97.8±15 kgf·m
 (707±108 lbf·ft)

- (6) Remove the swing motor assembly.
- ※ When removing the swing motor assembly, check that all the piping have been disconnected.

2) INSTALL

- (1) Carry out installation in the reverse order to removal.
- (2) Bleed the air from the swing motor.
 - ① Remove the air vent plug.
 - ② Pour in hydraulic oil until it over flows from the port.
 - ③ Tighten plug lightly.
 - ④ Start the engine, run at low idling, and check oil come out from plug.
 - ⑤ Tighten plug fully.
- (3) Confirmed the hydraulic oil level and check the hydraulic oil leak or not.



13031GE18

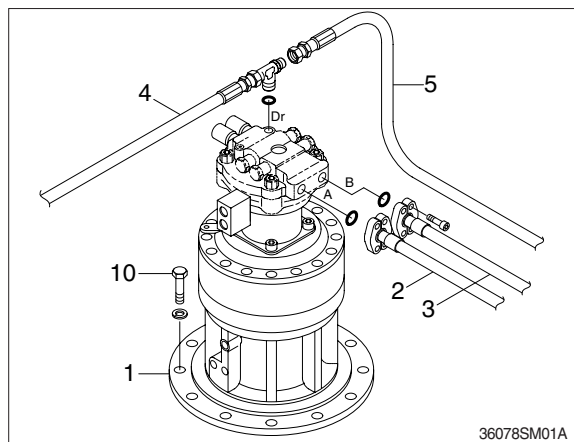

36078SM01A

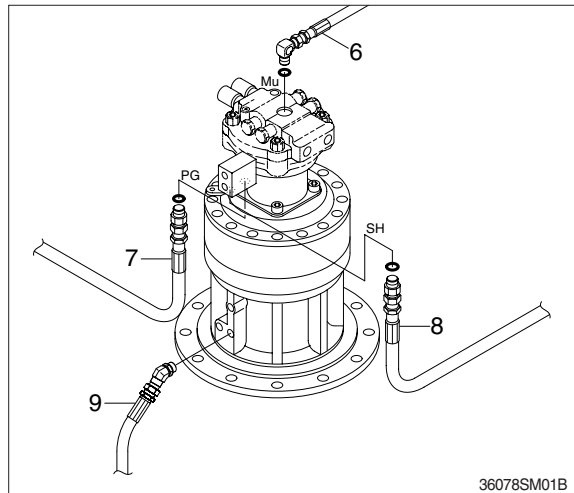

36078SM01B

2. SWING MOTOR

1) STRUCTURE

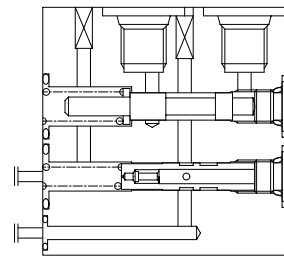
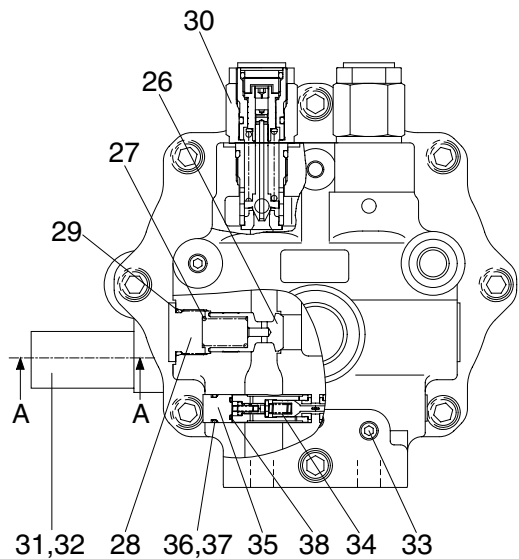
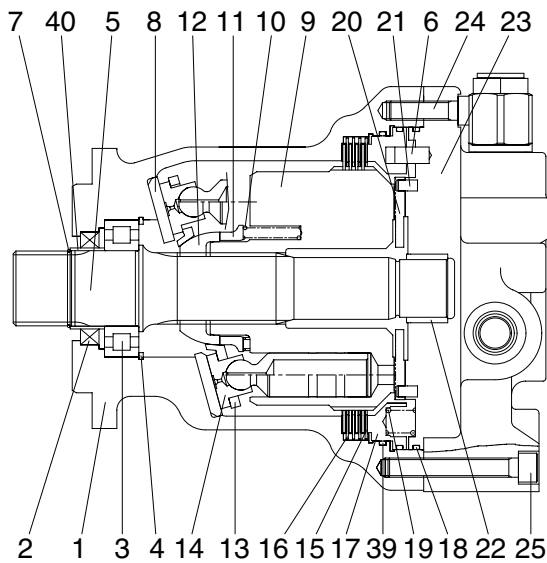

SECTION A-A

3802SM02

1	Body	15	Friction plate	29	O-ring
2	Oil seal	16	Plate	30	Relief valve assy
3	Roller bearing	17	Brake piston	31	Time delay valve
4	Snap ring	18	O-ring	32	Wrench bolt
5	Shaft	19	Spring	33	Plug
6	Pin	20	Valve plate	34	Swing reactionless valve assy
7	Stop ring	21	Pin	35	Plug
8	Shoe plate	22	Needle bearing	36	O-ring
9	Cylinder block	23	Rear cover	37	Back up ring
10	Spring	24	Wrench bolt	38	O-ring
11	Ball guide seat	25	Wrench bolt	39	O-ring
12	Ball guide	26	Poppet	40	Bushing
13	Set plate	27	Spring		
14	Piston assy	28	Plug		

2) TOOLS AND TIGHTENING TORQUE

(1) Tools

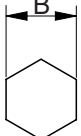
Tool name	Remark	
Allen wrench	5	
	6	
	12	
	17	
Socket for socket wrench, spanner	36	
Torque wrench	Capable of tightening with the specified torques	
Snap ring plier(for holes, axis)	Snap ring(4)	
Solder hammer	Needle bearing(22), pin(6, 21)	
Oil seal inserting jig	Oil seal(2)	
Induction heating apparatus for bearing	Roller bearing(3)	

(2) Tightening torque

Part name	Item	Size	Torque		Wrench size	
			kgf · m	lbf · ft	in	mm
Wrench bolt	24	M14	20.9	151.2	0.47	12
Wrench bolt	25	M14	20.9	151.2	0.47	12
Relief valve	30	M33	18.0	130.2	1.42	36
Wrench bolt	32	PF 1/4	6.9	49.9	0.20	5
Plug	33	PF 1/4	20.9	151.2	0.24	6

2) DISASSEMBLING

(1) Disassemble the sub of a TURNING AXIS

- ① Unloosing wrench bolt (32) and disassemble time delay valve assy (31) from rear cover (23)

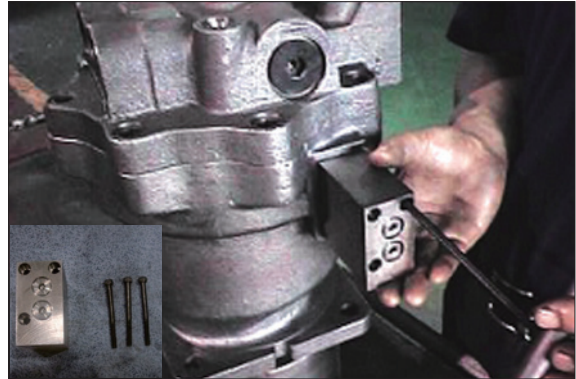

3607A8SM01/01A

- ② Hang rear cover (23) on hoist, unloose wrench bolt (24, 25) and disassemble from body (1).

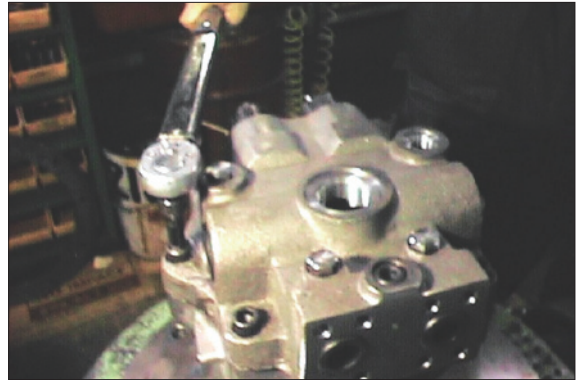

3607A8SM02

- ③ Using a jig, disassemble break piston (17) from body (1).

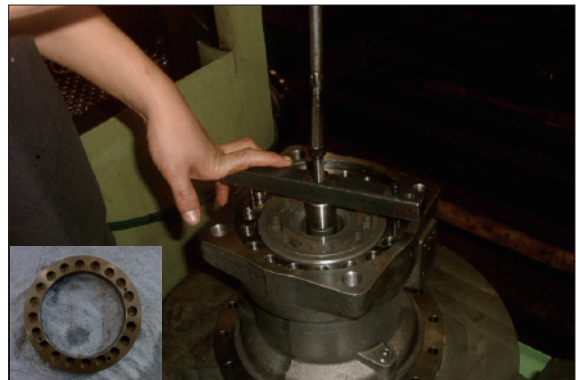

3607A8SM03

- ④ Disassemble respectively cylinder block assy, fricktion plate (15), plate (16) from body (1).



3607A8SM04

- ⑤ Disassemble shoe plate (8) from body (1).

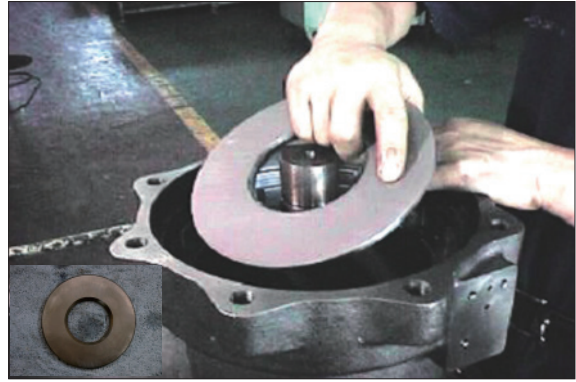

3607A8SM05

- ⑥ Using a plier jig, disassemble snap ring (4) and shaft assy (5).



3607A8SM06/06A

(2) Disassemble cylinder block assy sub

- ① Disassemble piston assy (14), set plate (13) from cylinder block assy.



3607A8SM07

- ② Disassemble ball guide (12), friction plate (15), plate (16) and ball guide seat (11) from cylinder block (9).

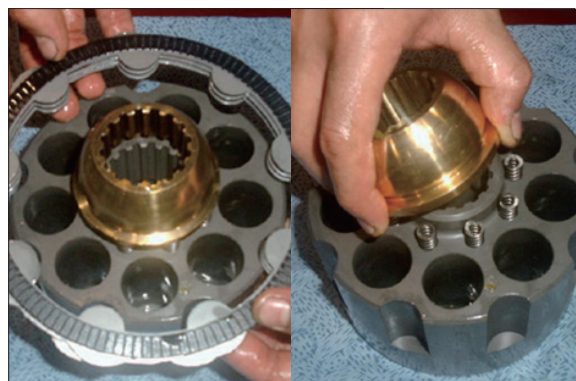

3607A8SM08A/08B

- ③ Disassemble spring (10) from cylinder block (9).

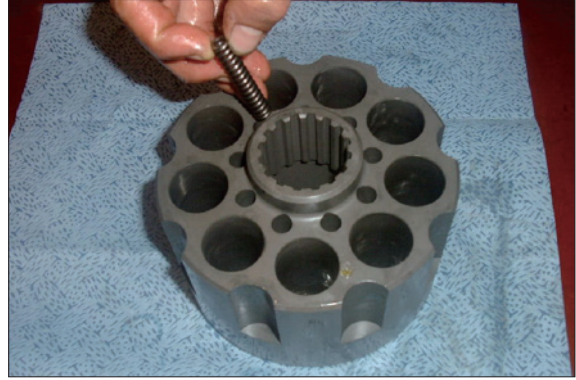

3607A8SM09

(3) Disassemble rear cover assy sub

- ① Disassemble pin (6, 21) and valve plate (20) from rear cover (23).

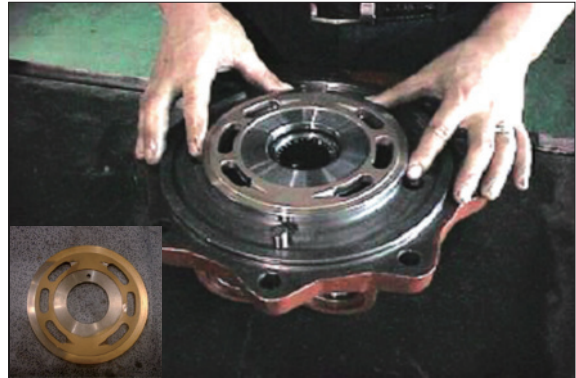

3607A8SM10/10A

- ② Using a torque wrench, disassemble relief valve assy (30) 2 set from rear cover (23).

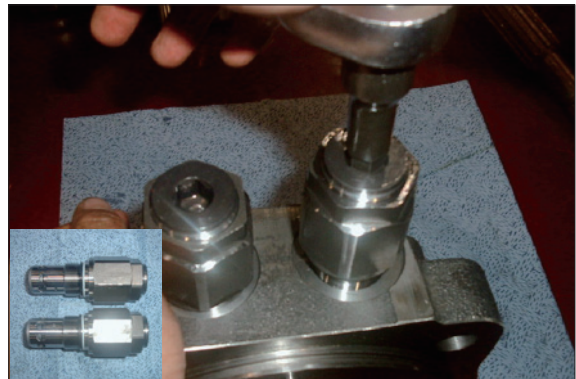

3607A8SM11/11A

- ③ Disassemble make up check valve assy with a torque wrench from rear cover (23).



3607A8SM12/12A

4) ASSEMBLING

(1) Assemble the sub of a turning axls

- ① Put roller bearing (3) on preheater and provide heat to inner wheel (compressing temp : 290°C for 2 minutes)
 - Roller bearing × 1EA



3607A8SM21

- ② After assembling and compressing pre-heated roller bearing (3), stop ring (7) into shaft (5).
 - Stop ring × 1EA
 - Shaft × 1EA



3607A8SM22/22A

- ③ Using a compressing tool and steel stick, assemble oil seal (2) into body (1).
 - Oil seal × 1EA



3607A8SM23/23A

- ④ Insert above shaft sub into body (1) and assemble it with a hammer.

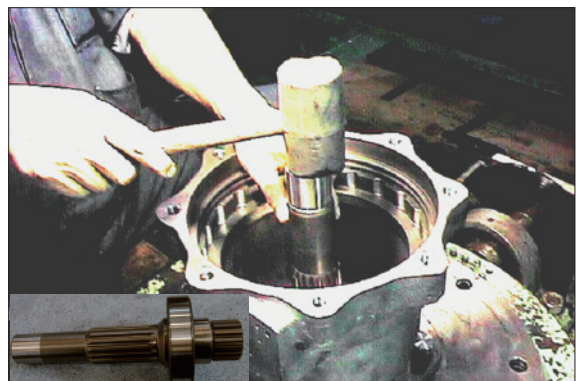

3607A8SM24

- ⑤ Fix snap ring (4) to shaft with a plier jig.
· Snap ring × 1EA



3607A8SM06

- ⑥ Spread grease on shoe plate (8) and assemble on the body.
· Shoe plate × 1EA



3607A8SM05

(2) Assemble the sub of cylinder block assy

- ① Assemble spring (10) 9 set into cylinder block (9).
· Spring × 9EA



3607A8SM25

- ② Assemble ball guide (12) and ball guide seat (11) into cylinder block (9).
· Ball guide × 1EA



3607A8SM26

- ③ Assemble piston assy (14) 9 set into set plate (13).
- Piston assy × 9EA
 - Set plate × 1EA

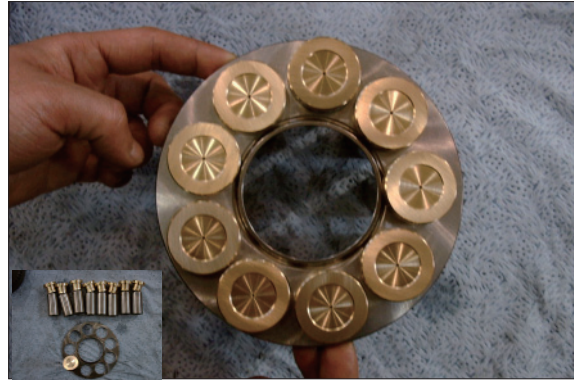

3607A8SM27

- ④ Assemble above item ② and ③.



3607A8SM28

- ⑤ Assemble cylinder block assy into body (1).



3607A8SM04

- ⑥ Assemble 4 set of lining plate (16), friction plate (15) respectively into body.
- Lining plate × 4EA
 - Friction plate × 4EA



3607A8SM29

- ⑦ Assemble O-ring (18) into break piston (17).
 · O-ring × 2EA



3607A8SM30

- ⑧ Insert break piston assy into body (1) and assemble spring (19) into break piston (17).
 · Spring × 19EA

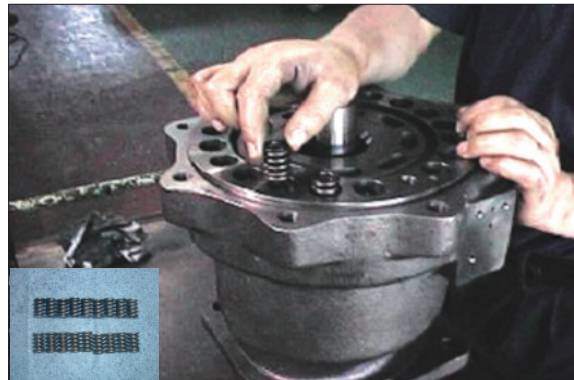

3607A8SM31/31A

(3) Assemble the sub of rear cover assy sub

- ① After assembling needle bearing (22) into rear cover (23), with a hammer assemble pin (6, 21).

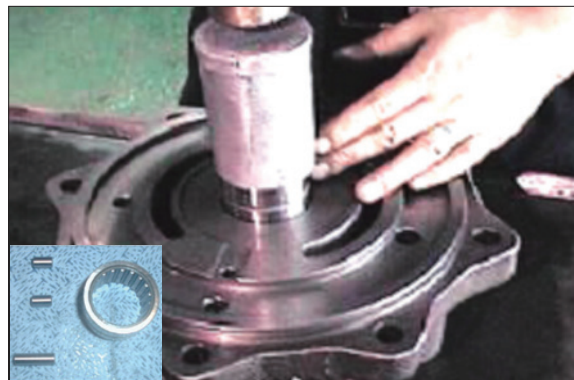

3607A8SM32/32A

- ② Assemble respectively make up check valve assy spring (27), poppet (26), plug (28) into rear cover (23) after then screw it torque wrench.
 · Make up check sub × 2set
 · Spring × 2EA
 · Check × 3EA

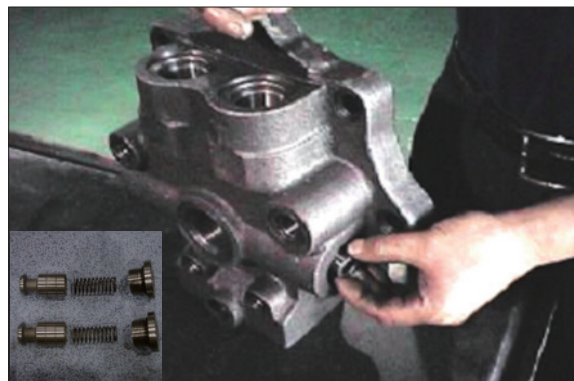

3607A8SM33/12A

- ③ Assemble relief valve assy (30) 2set into rear cover (23) with a torque wrench.

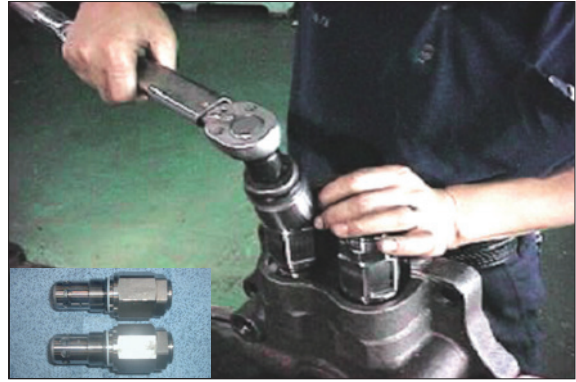

3607A8SM34/11A

- ④ Spreading grease on valve plate (20), assemble into rear cover (23).
· Valve plate × 1EA



3607A8SM10/10A

- ⑤ Lift up rear cover assy on body (1) by a crane and assemble it with a wrench bolt (24, 25).

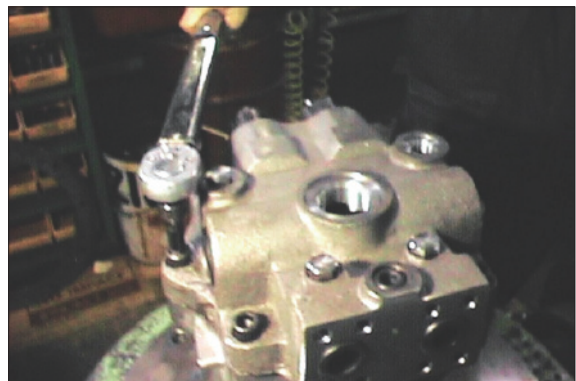

3607A8SM02

- ⑥ Assemble time delay valve assy (31) into rear cover (23) with a wrench bolt (32).

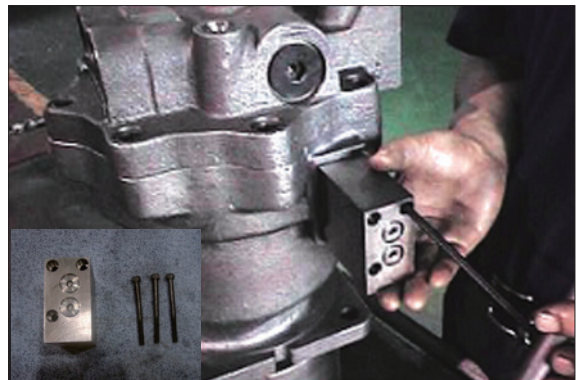

3607A8SM01/01A

(4) Air pressing test

Be sure of leakage, after press air into assembled motor.

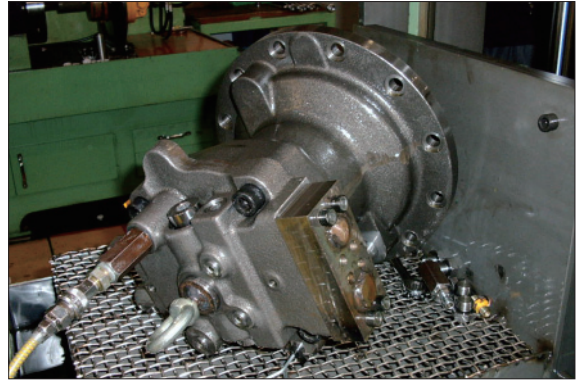

14078SM232

(5) Leakage check

After cleaning motor by color check No.1, paint No.3 and be sure of leakage.

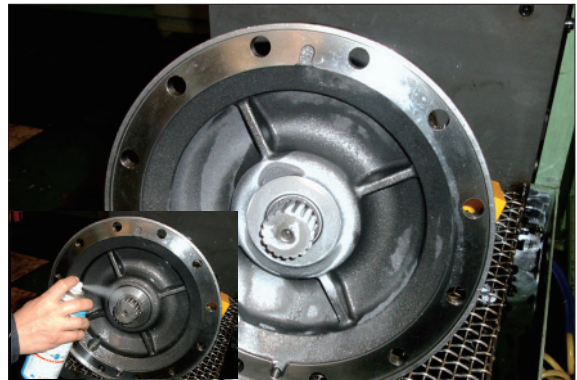

14078SM233/233A

(6) Mount test bench

Mounting motor test bench, test the availability of each part.

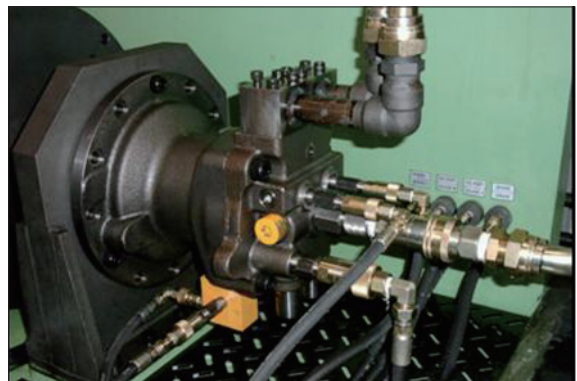

220078SM14

3. REDUCTION GEAR

1) STRUCTURE

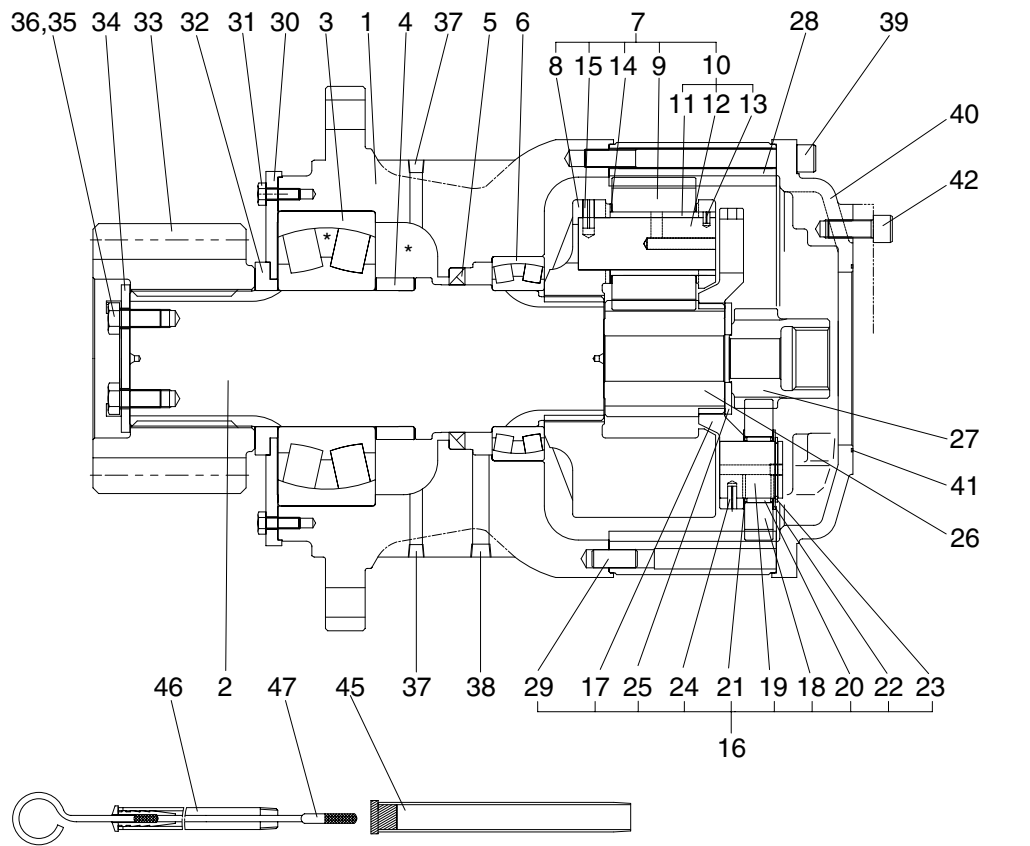

38092SM03

1	Casing	17	Carrier 1	33	Pinion gear
2	Drive shaft	18	Planetary gear 1	34	Lock plate
3	Roller bearing	19	Pin 1	35	Hexagon bolt
4	Spacer ring	20	Needle cage	36	Lock washer
5	Oil seal	21	Side plate 1	37	Plug
6	Roller bearing	22	Side plate 2	38	Plug
7	Carrier 2	23	Stop ring	39	Socket bolt
8	Carrier 2	24	Spring pin	40	Cover
9	Planetary gear 2	25	Thrust ring	41	O-ring
10	Pin 2	26	Sun gear 2	42	Hexagon socket bolt
11	Pin 2	27	Sun gear 1	43	Plug
12	Bushing 2	28	Ring gear	45	Air breather assy
13	Spring pin	29	Knock pin	46	Gauge pipe
14	Thrust washer	30	Cover plate	47	Gauge bar
15	Spring pin	31	Hexagon bolt		
16	Carrier 1	32	Spacer		

2) DISASSEMBLY

(1) Removal of cover

- ※ Loosen the socket bolt (24) with 16mm hexagonal socket and remove the cover (37).

(2) Removal of sun gear 1 and thrust ring assembly

Remove carrier 1(16), install eye bolt to tap hole (M10) and remove carrier 1 assembly itself.

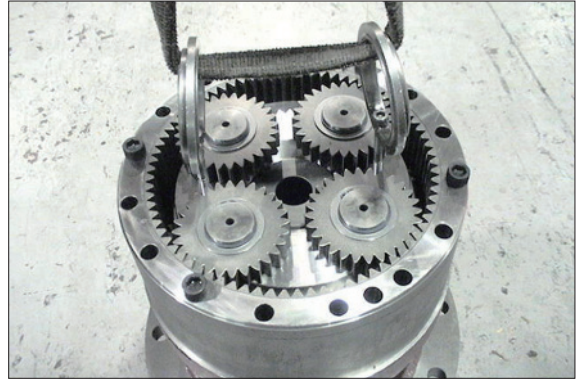

3607A8SR03

(3) Removal of sun gear 2

Remove sun gear 2 (26), install eye bolt to tap (M10) of carrier 2 (8) and remove carrier 2 assembly itself.

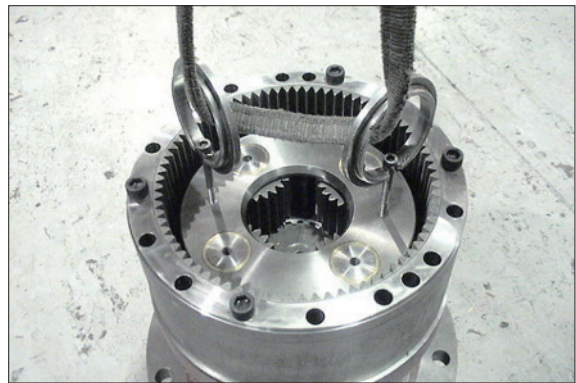

3607A8SR04

(4) Disassembly of 2nd carrier assembly

- ① Insert spring pin (15) into pin assy 2(11) by hammering.
- ※ Do not reuse spring pin after removal.

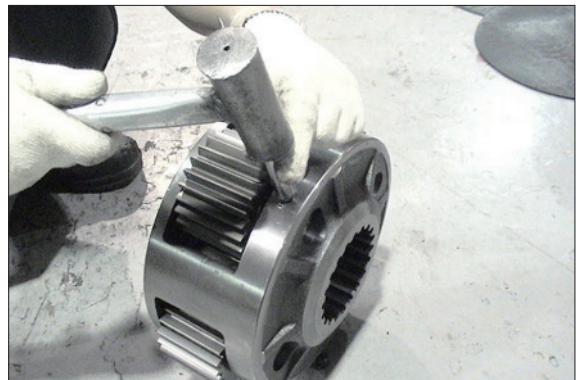

3607A8SR05

- ② Remove pin assy 2 (11) from carrier 2 (7), planetary gear 2 (9) and thrust washer (14) with hands.

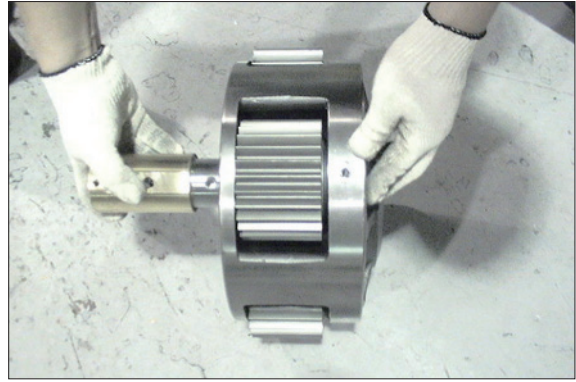

3607A8SR06

(5) Removal of ring gear

Remove ring gear (28) from casing (1).

- ※ Fluid packing is applied on contacting face of ring gear and gear casing. Therefore, remove ring gear from casing by minus screw driver.

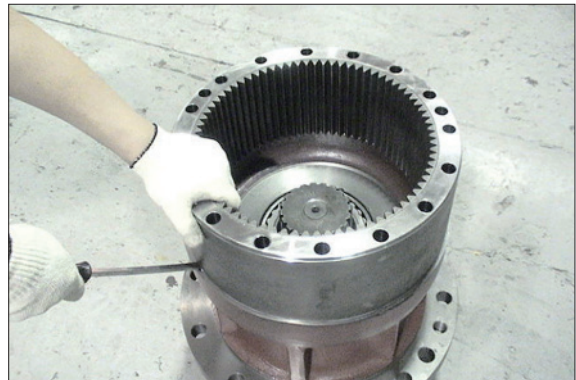

3607A8SR07

(6) Removal of drive shaft (2) assembly

- ① Spread off the corners of spacer (32), cover plate (30) and hex bolt (31) with a tool.

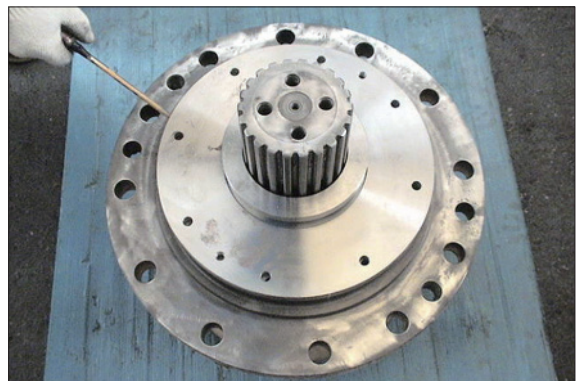

3607A8SR08

- ② Install hydraulic press at the end face of shaft, and remove drive shaft(2), spacer ring (4), and roller bearing (3) as assembly.

- ※ Do not reuse oil seal after removal.



3607A8SR09

- ③ Remove roller bearing (6) from gear casing (1).

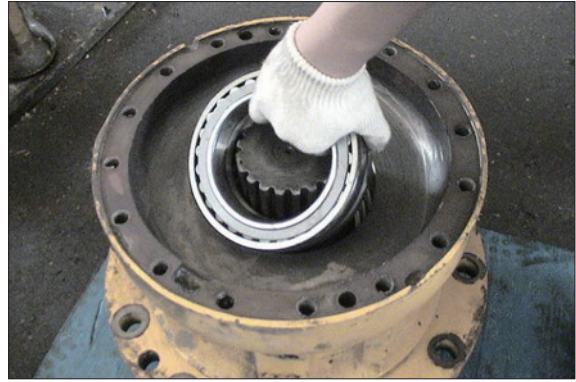

3607A8SR10

- ④ Remove oil seal (5) from gear casing (1).



3607A8SR11

(7) Disassembly of shaft assembly

Insert motor side of shaft (2) into steel tube (inner dia : \varnothing 145 mm) and push the end of output shaft side with hydraulic press and then remove roller bearing (3), and spacer ring (4) as assembly from drive shaft (2).



3607A8SR12

3) ASSEMBLY

(1) Assembly of drive shaft assembly

- ① After assembly drive shaft (2), heat roller bearing (3) up to 50°C plus surrounding temperature and assemble it to shaft with hydraulic press and then assemble spacer ring (4) in this order.
- ※ Pay attention to the assembling direction of cover plate (30).



3607A8SR13

(2) Installation of oil seal

Remove oil from assembled face of oil seal of gear casing (1) and oil seal (5). Apply fluid packing (three bond of white color) on outer face of oil seal and assemble at pressing jig of gear casing. After inserting with press, lubricate oil seal with grease.



3607A8SR14

(3) Assembly of drive shaft assembly

- ① Be careful lest oil seal lip damage by spline of drive shaft (2). Assemble drive shaft assembly by using seal guide.
- ② Put drive shaft of gear casing (1) upward. Assemble drive shaft assembly to gear casing by tightening eye bolt into tap hole (M16) of output side of drive shaft (2).
- ※ Place support (approx 150 mm) below of gear case (1) for seal protector contact with work table.



3607A8SR15

(4) Install of roller bearing

Put gear casing under output shaft and heat roller bearing (6) up to 50°C plus surrounding temperature and then assemble it to the shaft.

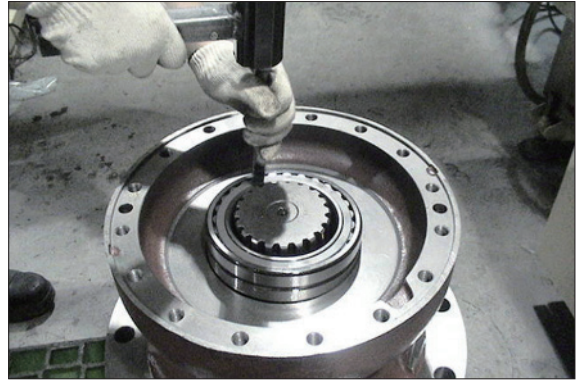

3607A8SR16

(5) Assembly of ring gear

- ① Remove oil from mating faces between gear casing (1) and ring gear (28), and knock pin (29). Assemble collar of gear casing and apply fluid packing (three bond of grey color).

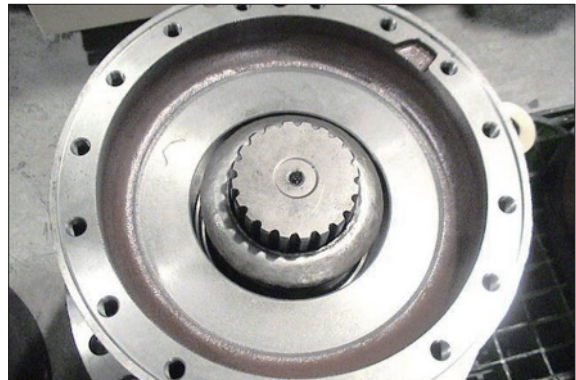

3607A8SR17

- ② Assemble ring gear (28).



36078SR18

(6) Assembly of carrier 2 assembly

- ① Assemble planetary gear 2 (9) to carrier 2 (8) with thrust washer (14) and insert pin assy 2 (11).
- ※ Lubricate gear oil to inside of gear and outside of shaft.

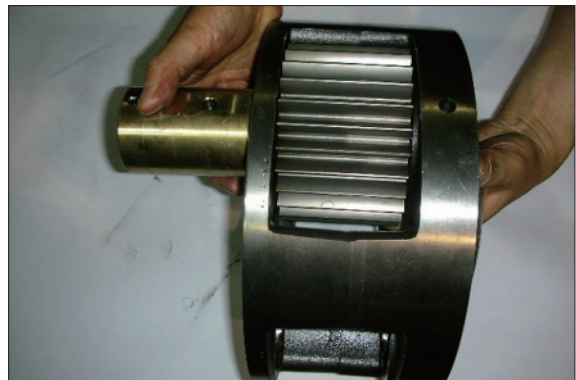

3607A8SR19

- ② Insert spring pin (15) by hammering.
- ※ Insert as the clearance between spring pins toward planetary gear 2 (9).

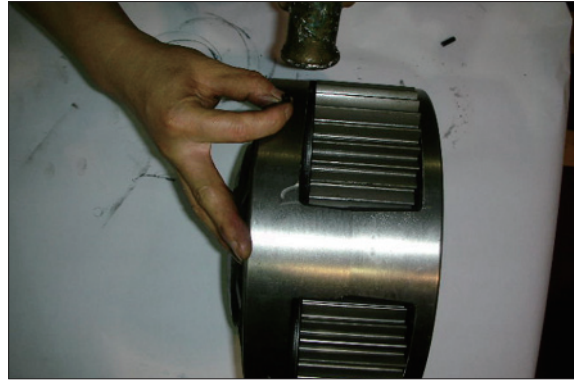

3607A8SR20

(7) Assembly of carrier 2 assembly and sun gear 2

- ① Mount eye bolt into tap hole (M10) of carrier 2 (8) and lift carrier assembly and then insert carrier assembly being engaged with internal teeth of ring gear (28). Rotate carrier assembly lightly so that splines of drive shaft (2) are engaged.

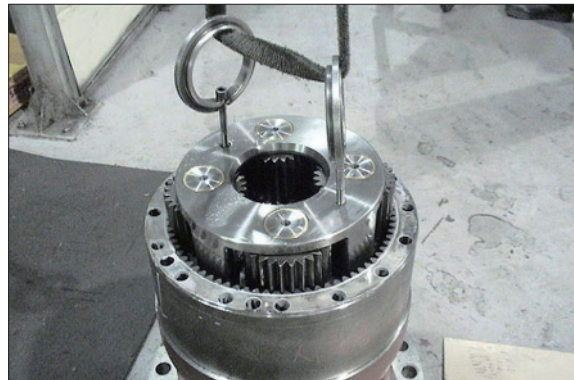

3607A8SR21

- ② Insert sun gear 2 (26) to planetary gear 2 (9).



3607A8SR22

(8) Assembly of sun gear 1, carrier 1 assembly

- ① Mount eye bolt into tap hole (M10) of lift carrier assembly and then insert carrier assembly being engaged with internal teeth of ring gear (28). Rotate holder assembly lightly so that sun gear 2 (26) is engaged with teeth of carrier 1 (17).

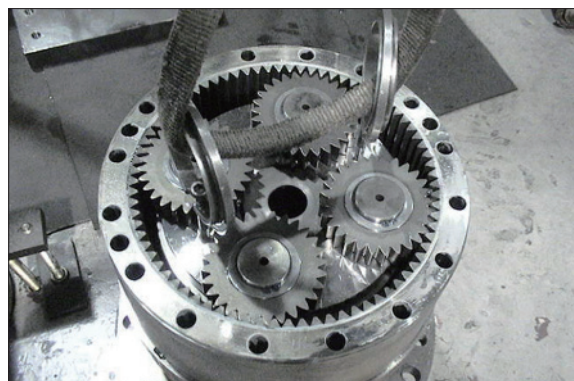

3607A8SR23

- ② Insert sun gear 1 (27) to planetary gear 1 (18).

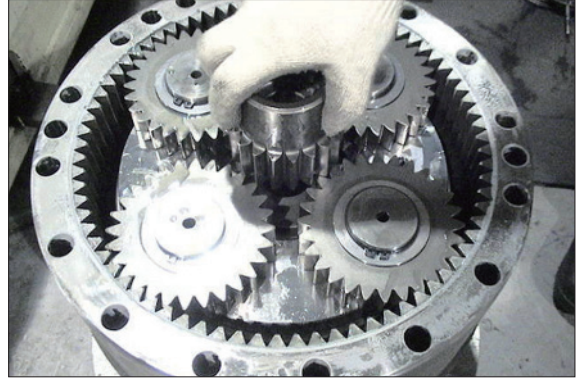

- (9) Check rotation of sun gear by turning plunge part of gear casing with hands.

(10) Assembly of cover

Remove oil from mating faces between ring gear (28) and cover (40) and apply fluid packing.

Assemble cover (40) and tighten socket bolt (39) with 16mm hexagonal socket.

Tightening torque : $28.5 \pm 3.0 \text{ kgf} \cdot \text{m}$
($206 \pm 21.7 \text{ lbf} \cdot \text{ft}$)

This completes assembly

