

GROUP 2 SPECIFICATIONS

1. MAJOR COMPONENT

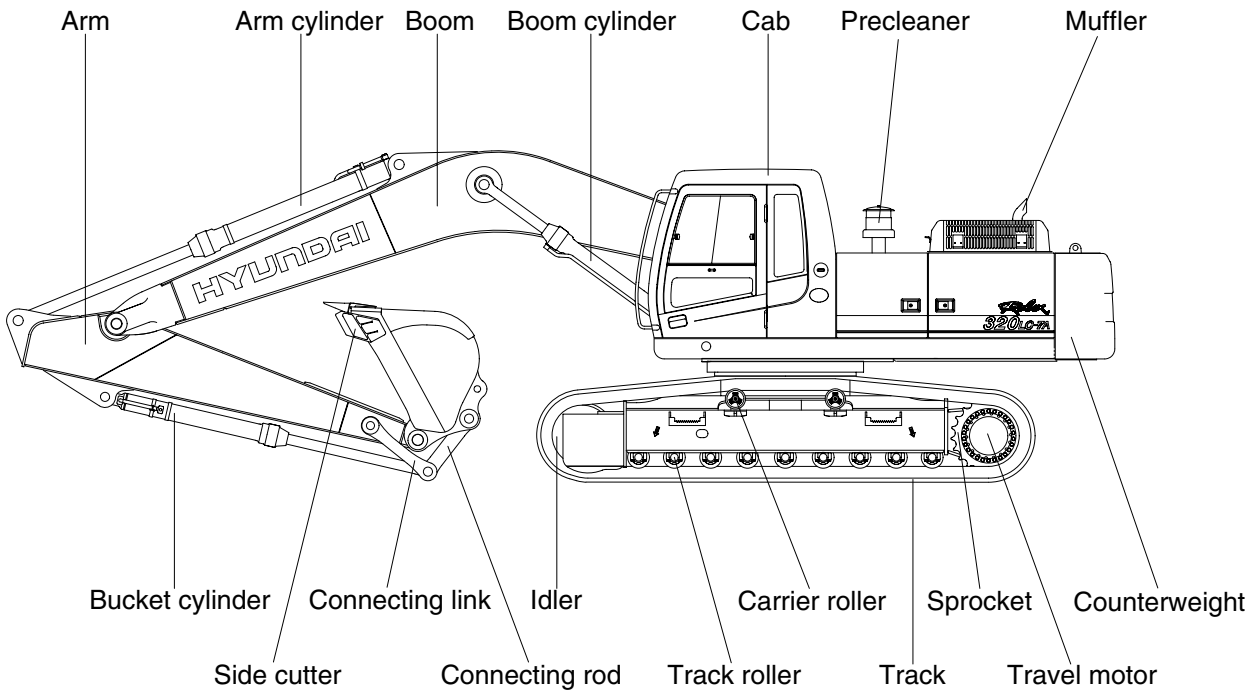
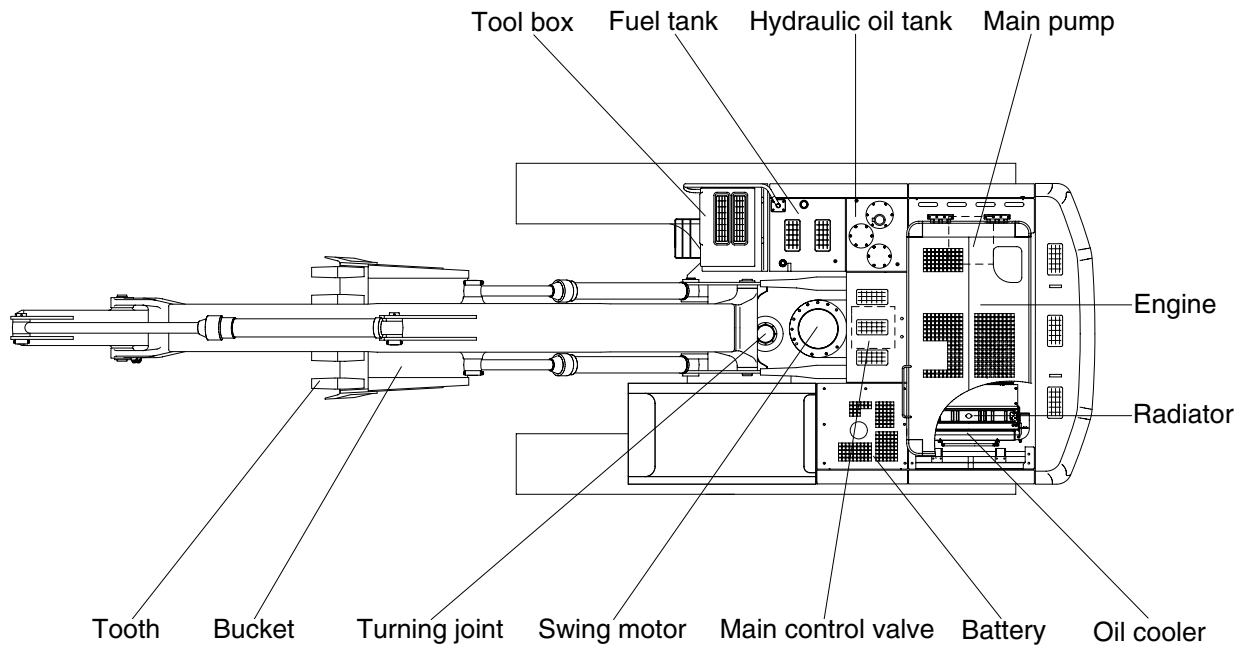

3207A2SP00

2. SPECIFICATIONS

1) R320LC-7A

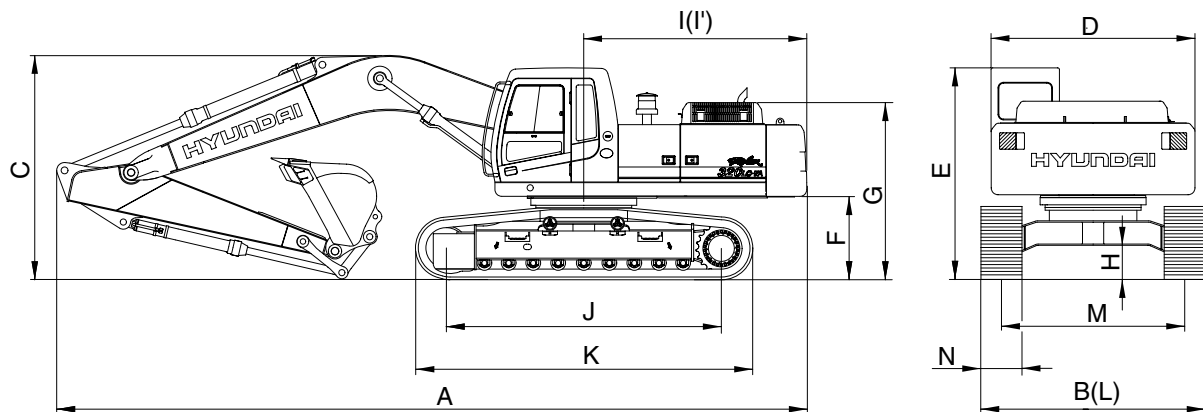

3207A2SP01

Description		Unit	Specification
Operating weight		kg(lb)	32200(70990)
Bucket capacity SAE heaped), standard		m ³ (yd ³)	1.44(1.88)
Overall length	A	mm(ft-in)	10980(36' 0")
Overall width, with 600mm shoe	B		3280(10' 9")
Overall height	C		3380(11' 1")
Superstructure width	D		2980(9' 9")
Overall height of cab	E		3090(10' 2")
Ground clearance of counterweight	F		1200(3' 11")
Engine cover height	G		2580(8' 6")
Minimum ground clearance	H		500(1' 8")
Rear-end distance	I		3265(10' 9")
Rear-end swing radius	I'		3330(10' 11")
Distance between tumblers	J		4030(13' 3")
Undercarriage length	K		4940(16' 2")
Undercarriage width	L		3280(10' 9")
Track gauge	M		2680(8' 10")
Track shoe width, standard	N		600(23.6")
Travel speed(Low/high)		km/hr(mph)	3.1/5.3(2.0/3.4)
Swing speed		rpm	9.1
Gradeability		Degree(%)	35(70)
Ground pressure(600mm shoe)		kgf/cm ² (psi)	0.62(8.82)

2) R320NLC-7A

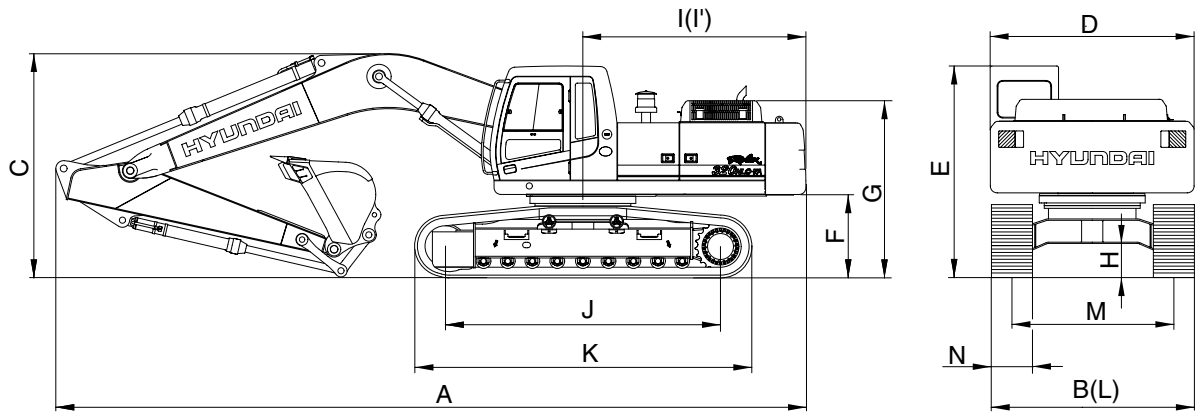

3207A2SP02

Description		Unit	Specification
Operating weight		kg(lb)	32000(70500)
Bucket capacity(SAE heaped), standard		m ³ (yd ³)	1.44(1.88)
Overall length	A	mm(ft-in)	10980(36' 0")
Overall width, with 600mm shoe	B		2990(9' 10")
Overall height	C		3380(11' 1")
Superstructure width	D		2980(9' 9")
Overall height of cab	E		3090(10' 2")
Ground clearance of counterweight	F		1200(3' 11")
Engine cover height	G		2580(8' 6")
Minimum ground clearance	H		500(1' 8")
Rear-end distance	I		3265(10' 9")
Rear-end swing radius	I'		3330(10' 11")
Distance between tumblers	J		4030(13' 3")
Undercarriage length	K		4940(16' 2")
Undercarriage width	L		2990(9' 10")
Track gauge	M		2390(7' 10")
Track shoe width, standard	N		600(23.6")
Travel speed(Low/high)		km/hr(mph)	3.1/5.3(2.0/3.4)
Swing speed		rpm	9.1
Gradeability		Degree(%)	35(70)
Ground pressure(600mm shoe)		kgf/cm ² (psi)	0.61(8.67)

3) R320NLC-7A HIGH WALKER

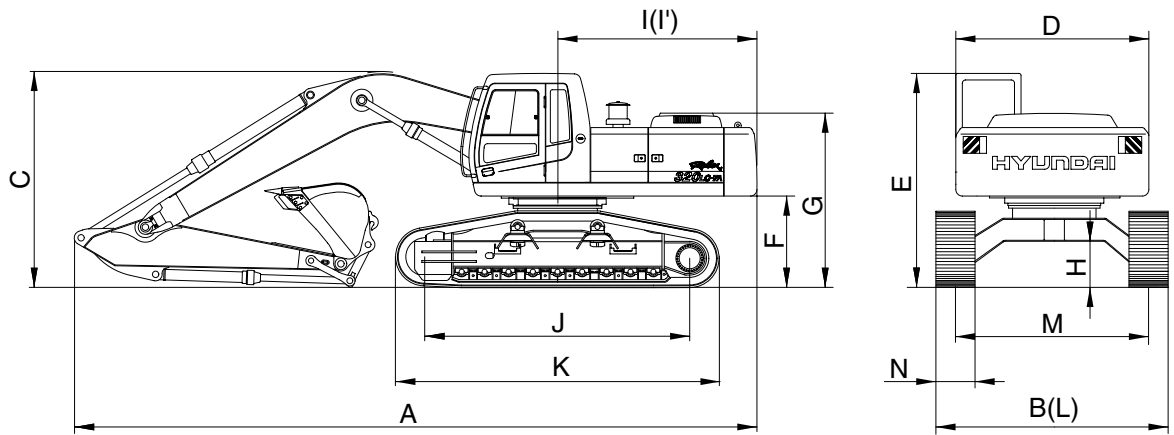

3207A2SP03

Description		Unit	Specification
Operating weight		kg(lb)	34700(76500)
Bucket capacity(SAE heaped), standard		m ³ (yd ³)	1.44(1.88)
Overall length	A	mm(ft-in)	10910(35' 10")
Overall width, with 600mm shoe	B		3470(11' 5")
Overall height	C		3360(11' 0")
Superstructure width	D		2980(9' 9")
Overall height of cab	E		3390(11' 1")
Ground clearance of counterweight	F		1500(4' 11")
Engine cover height	G		2880(9' 5")
Minimum ground clearance	H		765(2' 6")
Rear-end distance	I		3265(10' 9")
Rear-end swing radius	I'		3330(10' 11")
Distance between tumbler	J		4030(13' 3")
Undercarriage length	K		4940(16' 2")
Undercarriage width	L		3470(11' 5")
Track gauge	M		2870(9' 5")
Track shoe width, standard	N		600(23.6")
Travel speed(Low/high)		km/hr(mph)	3.1/5.3(2.0/3.4)
Swing speed		rpm	9.1
Gradeability		Degree(%)	35(70)
Ground pressure(600mm shoe)		kgf/cm ² (psi)	0.67(9.53)

3. WORKING RANGE

1) R320LC-7A, R320NLC-7A

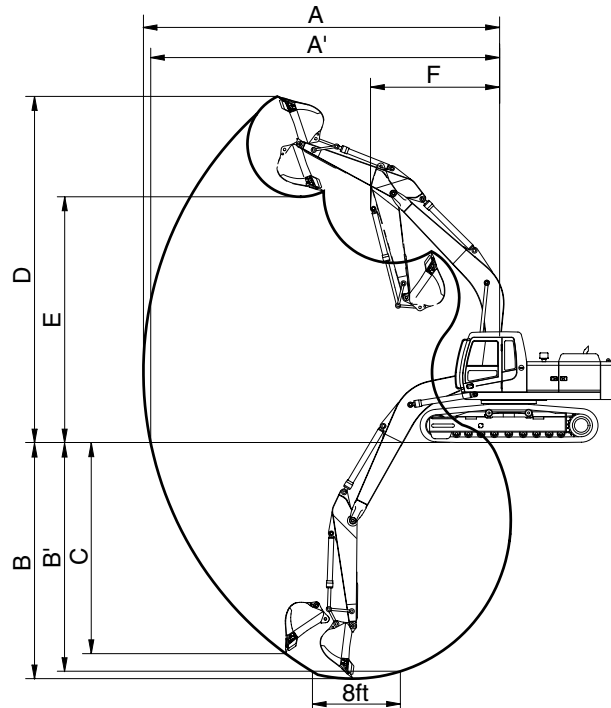

36072SP04

Description		6.45m(21' 2") Arm				6.15m(20' 2") Boom
		2.2m(7' 3") Arm	2.5m(8' 2") Arm	※ 3.2m(10' 6") Arm	4.05m(13' 3") Arm	2.2m(7' 3") Arm
Max digging reach	A	10330mm (33' 11")	10550mm (34' 7")	11140mm (36' 7")	11950mm (39' 2")	10020mm (32' 10")
Max digging reach on ground	A'	10110mm (33' 2")	10330mm (33' 11")	10940mm (35' 11")	11760mm (38' 7")	9800mm (32' 2")
Max digging depth	B	6370mm (20' 11")	6670mm (21' 11")	7370mm (24' 2")	8220mm (26' 12")	6160mm (20' 3")
Max digging depth (8ft level)	B'	6160mm (20' 3")	6470mm (21' 3")	7210mm (23' 8")	8080mm (26' 6")	5950mm (19' 6")
Max vertical wall digging depth	C	5980mm (19' 7")	5920mm (19' 5")	6360mm (20' 10")	7260mm (23' 10")	5710mm (18' 9")
Max digging height	D	10220mm (33' 6")	10170mm (33' 4")	10310mm (33' 10")	10710mm (35' 2")	9940mm (32' 7")
Max dumping height	E	7050mm (23' 2")	7050mm (23' 2")	7240mm (23' 9")	7630mm (25' 0")	6780mm (22' 3")
Min swing radius	F	4700mm (15' 5")	4500mm (14' 9")	4470mm (14' 8")	4470mm (14' 8")	4520mm (14' 10")
Bucket digging force	SAE	177.5[193.6] kN	177.5[193.6] kN	177.5[193.6] kN	177.5[193.6] kN	177.5[193.6] kN
		18100[19750] kgf	18100[19750] kgf	18100[19750] kgf	18100[19750] kgf	18100[19750] kgf
		39900[43530] lbf	39900[43530] lbf	39900[43530] lbf	39900[43530] lbf	39900[43530] lbf
	ISO	198.1[216.1] kN	198.1[216.1] kN	198.1[216.1] kN	198.1[216.1] kN	198.1[216.1] kN
		20200[22040] kgf	20200[22040] kgf	20200[22040] kgf	20200[22040] kgf	20200[22040] kgf
		44530[48580] lbf	44530[48580] lbf	44530[48580] lbf	44530[48580] lbf	44530[48580] lbf
Arm crowd force	SAE	185.3[202.2] kN	168.7[184.0] kN	132.4[144.4] kN	112.8[123.0] kN	185.3[202.2] kN
		18900[20620] kgf	17200[18760] kgf	13500[14730] kgf	11500[12550] kgf	18900[20620] kgf
		41670[45460] lbf	37920[41370] lbf	29760[32470] lbf	25350[27650] lbf	41670[45460] lbf
	ISO	191.2[208.6] kN	174.6[190.4] kN	136.3[148.7] kN	115.7[126.2] kN	191.2[208.6] kN
		19500[21270] kgf	17800[19420] kgf	13900[15160] kgf	11800[12870] kgf	19500[21270] kgf
		42990[46900] lbf	39240[42810] lbf	30640[33430] lbf	26010[28370] lbf	42990[46900] lbf

[] : Power boost

※ : STD

2) R320LC-7A HIGH WALKER

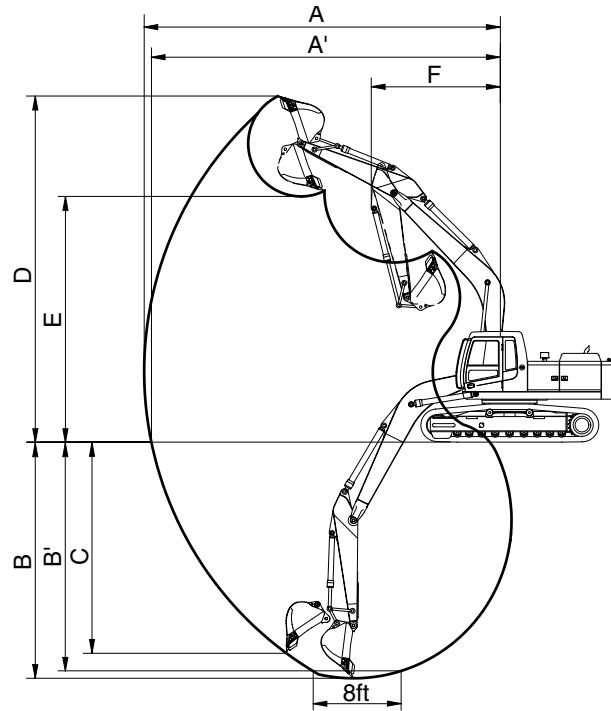

36072SP04

Description		6.45m(21' 2") Arm				6.15m(20' 2") Boom
		2.2m(7' 3") Arm	2.5m(8' 2") Arm	※ 3.2m(10' 6") Arm	4.05m(13' 3") Arm	2.2m(7' 3") Arm
Max digging reach	A	10330mm (33' 11")	10550mm (34' 7")	11140mm (36' 7")	11950mm (39' 2")	10020mm (32' 10")
Max digging reach on ground	A'	10040mm (32' 11")	10270mm (33' 8")	10880mm (35' 8")	11710mm (38' 5")	9730mm (31' 11")
Max digging depth	B	6100mm (20' 0")	6400mm (20' 12")	7100mm (23' 4")	7950mm (26' 1")	5880mm (19' 3")
Max digging depth (8ft level)	B'	5890mm (19' 4")	6200mm (20' 4")	6940mm (22' 9")	7800mm (25' 7")	5680mm (18' 8")
Max vertical wall digging depth	C	5700mm (18' 8")	5650mm (18' 6")	6080mm (19' 11")	6980mm (22' 11")	5440mm (17' 10")
Max digging height	D	10500mm (34' 5")	10450mm (34' 3")	10590mm (34' 9")	10990mm (36' 1")	10220mm (33' 6")
Max dumping height	E	7330mm (24' 1")	7330mm (24' 1")	7520mm (24' 8")	7910mm (25' 11")	7060mm (23' 2")
Min swing radius	F	4700mm (15' 5")	4500mm (14' 9")	4470mm (14' 8")	4470mm (14' 8")	4520mm (14' 10")
Bucket digging force	SAE	177.5[193.6] kN	177.5[193.6] kN	177.5[193.6] kN	177.5[193.6] kN	177.5[193.6] kN
		18100[19750] kgf	18100[19750] kgf	18100[19750] kgf	18100[19750] kgf	18100[19750] kgf
		39900[43530] lbf	39900[43530] lbf	39900[43530] lbf	39900[43530] lbf	39900[43530] lbf
	ISO	198.1[216.1] kN	198.1[216.1] kN	198.1[216.1] kN	198.1[216.1] kN	198.1[216.1] kN
		20200[22040] kgf	20200[22040] kgf	20200[22040] kgf	20200[22040] kgf	20200[22040] kgf
		44530[48580] lbf	44530[48580] lbf	44530[48580] lbf	44530[48580] lbf	44530[48580] lbf
Arm crowd force	SAE	185.3[202.2] kN	168.7[184.0] kN	132.4[144.4] kN	112.8[123.0] kN	185.3[202.2] kN
		18900[20620] kgf	17200[18760] kgf	13500[14730] kgf	11500[12550] kgf	18900[20620] kgf
		41670[45460] lbf	37920[41370] lbf	29760[32470] lbf	25350[27650] lbf	41670[45460] lbf
	ISO	191.2[208.6] kN	174.6[190.4] kN	136.3[148.7] kN	115.7[126.2] kN	191.2[208.6] kN
		19500[21270] kgf	17800[19420] kgf	13900[15160] kgf	11800[12870] kgf	19500[21270] kgf
		42990[46900] lbf	39240[42810] lbf	30640[33430] lbf	26010[28370] lbf	42990[46900] lbf

[] : Power boost

※ : STD

4. WEIGHT

1) R320LC-7A, R320NLC-7A

Item	R320LC-7A		R320NLC-7A	
	kg	lb	kg	lb
Upperstructure assembly	14520	31590	←	←
Main frame weld assembly	2680	5900	←	←
Engine assembly	590	1300	←	←
Main pump assembly	180	380	←	←
Main control valve assembly	200	440	←	←
Swing motor assembly	310	680	←	←
Hydraulic oil tank assembly	230	490	←	←
Fuel tank assembly	210	450	←	←
Counterweight	6200	13670	←	←
Cab assembly	310	680	←	←
Radiator total assy	280	620	←	←
Lower chassis assembly	11500	25770	11360	25040
Track frame weld assembly	3970	8750	3835	8450
Swing bearing	410	900	←	←
Travel motor assembly	390	860	←	←
Turning joint	50	110	←	←
Tension cylinder	210	450	←	←
Idler	250	540	←	←
Sprocket	80	170	←	←
Carrier roller	40	80	←	←
Track roller	60	120	←	←
Track-chain assembly(600mm standard triple grouser shoe)	1860	4100	←	←
Front attachment assembly(6.45m boom, 3.2m arm, 1.44m ³ SAE heaped bucket)	6390	14090	←	←
6.45m boom assembly	2530	5580	←	←
3.2m arm assembly	1160	2560	←	←
1.44m ³ SAE heaped bucket	1120	2470	←	←
Boom cylinder assembly	280	620	←	←
Arm cylinder assembly	380	840	←	←
Bucket cylinder assembly	270	570	←	←
Bucket control linkage assembly	370	820	←	←

2) R320LC-7A HIGH WALKER











Item	R320LC-7A HIGH WALKER	
	kg	lb
Upperstructure assembly	14520	31590
Main frame weld assembly	2680	5900
Engine assembly	590	1300
Main pump assembly	180	380
Main control valve assembly	200	440
Swing motor assembly	310	680
Hydraulic oil tank assembly	230	490
Fuel tank assembly	210	450
Counterweight	6200	13670
Cab assembly	310	680
Radiator total assy	280	620
Lower chassis assembly	13360	29450
Track frame weld assembly	5825	12840
Swing bearing	410	900
Travel motor assembly	390	860
Turning joint	50	110
Tension cylinder	210	450
Idler	250	540
Sprocket	80	170
Carrier roller	40	80
Track roller	60	120
Track-chain assembly(600mm standard triple grouser shoe)	1860	4100
Front attachment assembly(6.45m boom, 3.2m arm, 1.44m ³ SAE heaped bucket)	6390	14090
6.45m boom assembly	2530	5580
3.2m arm assembly	1160	2560
1.44m ³ SAE heaped bucket	1120	2470
Boom cylinder assembly	280	620
Arm cylinder assembly	380	840
Bucket cylinder assembly	270	570
Bucket control linkage assembly	370	820

5. LIFTING CAPACITIES

1) R320LC-7A











(1) 6.15m(20' 2") boom, 2.2m(7' 3") arm equipped with 1.44m³(SAE heaped) bucket and 600mm (24") triple grouser shoe and 6200kg(13670lb) counterweight.

-  : Rating over-front
-  : Rating over-side or 360 degree













Load point height		Load radius								At max. reach		
		3.0m(10.0ft)		4.5m(15.0ft)		6.0m(20.0ft)		7.5m(25.0ft)		Capacity		Reach
												m(ft)
7.5m (25.0ft)	kg lb									*6910 *15230	5680 12520	7.69 (25.2)
6.0m (20.0ft)	kg lb					*7760 *17110	*7760 *17110	*7460 *16450	5770 12720	*6960 *15340	4510 9940	8.61 (28.2)
4.5m (15.0ft)	kg lb			*11210 *24710	*11210 *24710	*8910 *19640	8260 18210	*7850 *17310	5630 12410	6180 13620	3920 8640	9.16 (30.1)
3.0m (10.0ft)	kg lb			*14450 *31860	12090 26650	*10390 *22910	7760 17110	8500 18740	5400 11900	5810 12810	3650 8050	9.39 (30.8)
1.5m (5.0ft)	kg lb			*16730 *36880	11300 24910	*11700 *25790	7330 16160	8250 18190	5180 11420	5780 12740	3610 7960	9.35 (30.7)
Ground Line	kg lb			*17390 *38340	11020 24290	11570 25510	7070 15590	8080 17810	5030 11090	6090 13430	3800 8380	9.02 (29.6)
-1.5m (-5.0ft)	kg lb	*16010 *35300	*16010 *35300	*16940 *37350	11010 24270	11480 25310	7000 15430	8040 17730	5000 11020	6900 15210	4330 9550	8.37 (27.5)
-3.0m (-10.0ft)	kg lb	*21280 *46910	*21280 *46910	*15440 *34040	11200 24690	*11470 *25290	7100 15650			*7700 *16980	5530 12190	7.29 (23.9)
-4.5m (-15.0ft)	kg lb	*16550 *36490	*16550 *36490	*12170 *26830	11630 25640							

- Note
1. Lifting capacity are based on SAE J1097 and ISO 10567.
 2. Lifting capacity of the ROBEX series does not exceed 75% of tipping load with the machine on firm, level ground or 87% of full hydraulic capacity.
 3. The load point is a hook located on the back of the bucket.
 4. *indicates load limited by hydraulic capacity.















(2) 6.45m(21' 2") boom, 2.2m(7' 3") arm equipped with 1.44m³(SAE heaped) bucket and 600mm (24") triple grouser shoe and 6200kg(13670lb) counterweight.

Load point height		Load radius								At max. reach		
		3.0m(10.0ft)		4.5m(15.0ft)		6.0m(20.0ft)		7.5m(25.0ft)		Capacity		Reach
												m(ft)
7.5m (25.0ft)	kg lb									*6570 *14480	5120 11290	8.07 (26.5)
6.0m (20.0ft)	kg lb					*7600 *16760	*7600 *16760	*7100 *15650	5710 12590	6450 14220	4110 9060	8.95 (29.4)
4.5m (15.0ft)	kg lb			*11460 *25260	*11460 *25260	*8830 *19470	8070 17790	*7610 *16780	5520 12170	5730 12630	3590 7910	9.47 (31.1)
3.0m (10.0ft)	kg lb					*10320 *22750	7530 16600	8350 18410	5260 11600	5400 11900	3350 7390	9.70 (31.8)
1.5m (5.0ft)	kg lb					*11580 *25530	7090 15630	8080 17810	5030 11090	5370 11840	3310 7300	9.66 (31.7)
Ground Line	kg lb			*17110 *37720	10680 23550	11310 24930	6840 15080	7910 17440	4870 10740	5650 12460	3480 7670	9.34 (30.6)
-1.5m (-5.0ft)	kg lb	*13660 *30120	*13660 *30120	*16560 *36510	10730 23660	11240 24780	6780 14950	7870 17350	4830 10650	6350 14000	3940 8690	8.72 (28.6)
-3.0m (-10.0ft)	kg lb	*20480 *45150	*20480 *45150	*15160 *33420	10930 24100	11360 25040	6890 15190			*7290 *16070	4950 10910	7.70 (25.3)
-4.5m (-15.0ft)	kg lb	*16460 *36290	*16460 *36290	*12360 *27250	11350 25020							















(3) 6.45m(21' 2") boom, 2.5m(8' 2") arm equipped with 1.44m³(SAE heaped) bucket and 600mm (24") triple grouser shoe and 6200kg(13670lb) counterweight.

Load point height		Load radius									At max. reach			
		3.0m(10.0ft)		4.5m(15.0ft)		6.0m(20.0ft)		7.5m(25.0ft)		9.0m(30.0ft)		Capacity		Reach
														m(ft)
7.5m (25.0ft)	kg lb											*6180 *13620	4840 10670	8.34 (27.4)
6.0m (20.0ft)	kg lb							*6750 *14880	5750 12680			6170 13600	3920 8640	9.19 (30.2)
4.5m (15.0ft)	kg lb			*10750 *23700	*10750 *23700	*8420 *18560	8120 17900	*7310 *16120	5540 12210			5500 12130	3430 7560	9.70 (31.8)
3.0m (10.0ft)	kg lb			*14010 *30890	11740 25880	*9940 *21910	7550 16640	*8080 *17810	5260 11600			5190 11440	3190 7030	9.92 (32.5)
1.5m (5.0ft)	kg lb			*16290 *35910	10880 23990	*11280 *24870	7070 15590	8060 17770	5000 11020	5970 13160	3680 8110	5150 11350	3150 6940	9.88 (32.4)
Ground Line	kg lb			*16990 *37460	10590 23350	11260 24820	6790 14970	7860 17330	4820 10630			5390 11880	3300 7280	9.57 (31.4)
-1.5m (-5.0ft)	kg lb	*14220 *31350	*14220 *31350	*16670 *36750	10590 23350	11150 24580	6700 14770	7790 17170	4760 10490			6010 13250	3700 8160	8.97 (29.4)
-3.0m (-10.0ft)	kg lb	*21440 *47270	*21440 *47270	*15460 *34080	10760 23720	11240 24780	6770 14930					*7290 *16070	4590 10120	7.98 (26.2)
-4.5m (-15.0ft)	kg lb	*17640 *38890	*17640 *38890	*12990 *28640	11140 24560	*9520 *20990	7060 15560					*6680 *14730	*6680 *14730	6.42 (21.1)













(4) 6.45m(21' 2") boom, 3.2m(10' 6") arm equipped with 1.44m³(SAE heaped) bucket and 600mm (24") triple grouser shoe and 6200kg(13670lb) counterweight.

Load point height		Load radius												At max. reach		
		1.5m(5.0ft)		3.0m(10.0ft)		4.5m(15.0ft)		6.0m(20.0ft)		7.5m(25.0ft)		9.0m(30.0ft)		Capacity		Reach
																m(ft)
7.5m (25.0ft)	kg lb									*4880 *10760	*4880 *10760			*5500 *12130	4200 9260	9.06 (29.7)
6.0m (20.0ft)	kg lb									*6000 *13230	5890 12990			5510 12150	3470 7650	9.84 (32.3)
4.5m (15.0ft)	kg lb							*7490 *16510	*7490 *16510	*6640 *14640	5640 12430	*5070 *11180	3980 8770	4960 10930	3060 6750	10.31 (33.8)
3.0m (10.0ft)	kg lb					*12430 *27400	12180 26850	*9090 *20040	7700 16980	*7490 *16510	5320 11730	6140 13540	3830 8440	4690 10340	2850 6280	10.52 (34.5)
1.5m (5.0ft)	kg lb					*15210 *33530	11110 24490	*10610 *23390	7150 15760	8090 17840	5020 11070	5970 13160	3670 8090	4640 10230	2800 6170	10.48 (34.4)
Ground Line	kg lb			*9720 *21430	*9720 *21430	*16620 *36640	10580 23320	11260 24820	6780 14950	7830 17260	4790 10560	5830 12850	3540 7800	4810 10600	2900 6390	10.19 (33.4)
-1.5m (-5.0ft)	kg lb	*10800 *23810	*10800 *23810	*13710 *30230	*13710 *30230	*16830 *37100	10440 23020	11060 24380	6600 14550	7700 16980	4660 10270			5280 11640	3200 7050	9.63 (31.6)
-3.0m (-10.0ft)	kg lb	*14530 *32030	*14530 *32030	*18410 *40590	*18410 *40590	*16100 *35490	10510 23170	11050 24360	6600 14550	7700 16980	4670 10300			6240 13760	3840 8470	8.74 (28.7)
-4.5m (-15.0ft)	kg lb			*20220 *44580	*20220 *44580	*14270 *31460	10790 23790	*10560 *23280	6780 14950					*6880 *15170	5250 11570	7.37 (24.2)
-6.0m (-20.0ft)	kg lb					*10450 *23040	*10450 *23040									















(5) 6.45m(21' 2") boom, 4.05m(13' 3") arm equipped with 1.44m³(SAE heaped) bucket and 600mm (24") triple grouser shoe and 6200kg(13670lb) counterweight.

Load point height		Load radius												At max. reach		
		1.5m(5.0ft)		3.0m(10.0ft)		4.5m(15.0ft)		6.0m(20.0ft)		7.5m(25.0ft)		9.0m(30.0ft)		Capacity		Reach
																m(ft)
7.5m (25.0ft)	kg lb													*4760 *10490	3440 7580	10.00 (32.8)
6.0m (20.0ft)	kg lb											*4160 *9170	*4160 *9170	4700 10360	2890 6370	10.71 (35.1)
4.5m (15.0ft)	kg lb									*5710 *12590	*5710 *12590	*5320 *11730	4030 8880	4270 9410	2570 5670	11.13 (36.5)
3.0m (10.0ft)	kg lb			*16820 *37080	*16820 *37080	*10330 *22770	*10330 *22770	*7880 *17370	*7880 *17370	*6640 *14640	5380 11860	*5940 *13100	3830 8440	4050 8930	2390 5270	11.32 (37.1)
1.5m (5.0ft)	kg lb			*9930 *21890	*9930 *21890	*13560 *29890	11450 25240	*9590 *21140	7260 16010	*7630 *16820	5030 11090	5940 13100	3630 8000	4000 8820	2340 5160	11.29 (37.0)
Ground Line	kg lb			*10280 *22660	*10280 *22660	*15690 *34590	10640 23460	*10950 *24140	6770 14930	7790 17170	4730 10430	5750 12680	3460 7630	4120 9080	2410 5310	11.03 (36.2)
-1.5m (-5.0ft)	kg lb	*9390 *20700	*9390 *20700	*12710 *28020	*12710 *28020	*16580 *36550	10290 22690	10950 24140	6490 14310	7580 16710	4540 10010	5630 12410	3350 7390	4450 9810	2620 5780	10.52 (34.5)
-3.0m (-10.0ft)	kg lb	*12370 *27270	*12370 *27270	*16100 *35490	*16100 *35490	*16450 *36270	10230 22550	10840 23900	6400 14110	7500 16530	4480 9880	5620 12390	3340 7360	5110 11270	3060 6750	9.72 (31.9)
-4.5m (-15.0ft)	kg lb	*15810 *34860	*15810 *34860	*20640 *45500	*20640 *45500	*15320 *33770	10390 22910	10930 24100	6470 14260	7590 16730	4550 10030			*6410 *14130	3940 8690	8.53 (28.0)
-6.0m (-20.0ft)	kg lb			*18370 *40500	*18370 *40500	*12770 *28150	10780 23770	*9220 *20330	6760 14900					*6150 *13560	6120 13490	6.71 (22.0)

(6) 6.45m(21' 2") boom, 2.5m(8' 2") arm equipped with 1.44m³(SAE heaped) bucket and 800mm (32") triple grouser shoe and 6200kg(13670lb) counterweight.

Load point height		Load radius										At max. reach				
		3.0m(10.0ft)		4.5m(15.0ft)		6.0m(20.0ft)		7.5m(25.0ft)		9.0m(30.0ft)		Capacity		Reach		
														kg	lb	m(ft)
7.5m (25.0ft)	kg lb													*6180 *13620	4990 11000	8.34 (27.4)
6.0m (20.0ft)	kg lb							*6750 *14880	5920 13050					*6260 *13800	4050 8930	9.19 (30.2)
4.5m (15.0ft)	kg lb			*10750 *23700	*10750 *23700	*8420 *18560	8350 18410	*7310 *16120	5710 12590				5690 12540	3560 7850	9.70 (31.8)	
3.0m (10.0ft)	kg lb			*14010 *30890	12080 26630	*9940 *21910	7780 17150	*8080 *17810	5430 11970				5370 11840	3310 7300	9.92 (32.5)	
1.5m (5.0ft)	kg lb			*16290 *35910	11220 24740	*11280 *24870	7300 16090	8320 18340	5170 11400	6180 13620	3810 8400		5330 11750	3270 7210	9.88 (32.4)	
Ground Line	kg lb			*16990 *37460	10930 24100	11620 25620	7010 15450	8130 17920	4990 11000				5580 12300	3420 7540	9.57 (31.4)	
-1.5m (-5.0ft)	kg lb	*14220 *31350	*14220 *31350	*16670 *36750	10920 24070	11520 25400	6920 15260	8050 17750	4920 10850				6220 13710	3840 8470	8.97 (29.4)	
-3.0m (-10.0ft)	kg lb	*21440 *47270	*21440 *47270	*15460 *34080	11100 24470	*11540 *25440	7000 15430						*7290 *16070	4740 10450	7.98 (26.2)	
-4.5m (-15.0ft)	kg lb	*17640 *38890	*17640 *38890	*12990 *28640	11480 25310	*9520 *20990	7290 16070						*6680 *14730	*6680 *14730	6.42 (21.1)	

(7) 6.45m(21' 2") boom, 3.2m(10' 6") arm equipped with 1.44m³(SAE heaped) bucket and 800mm (32") triple grouser shoe and 6200kg(13670lb) counterweight.

Load point height		Load radius										At max. reach						
		1.5m(5.0ft)		3.0m(10.0ft)		4.5m(15.0ft)		6.0m(20.0ft)		7.5m(25.0ft)		9.0m(30.0ft)		Capacity		Reach		
																kg	lb	m(ft)
7.5m (25.0ft)	kg lb									*4880 *10760	*4880 *10760					*5500 *12130	4340 9570	9.06 (29.7)
6.0m (20.0ft)	kg lb									*6000 *13230	*6000 *13230					*5620 *12390	3590 7910	9.84 (32.3)
4.5m (15.0ft)	kg lb							*7490 *16510	*7490 *16510	*6640 *14640	5800 12790	*5070 *11180	4120 9080	5130 11310	3180 7010	10.31 (33.8)		
3.0m (10.0ft)	kg lb					*12430 *27400	*12430 *27400	*9090 *20040	7930 17480	*7490 *16510	5490 12100	6350 14000	3970 8750	4860 10710	2970 6550	10.52 (34.5)		
1.5m (5.0ft)	kg lb					*15210 *33530	11440 25220	*10610 *23390	7370 16250	8350 18410	5180 11420	6170 13600	3800 8380	4810 10600	2910 6420	10.48 (34.4)		
Ground Line	kg lb			*9720 *21430	*9720 *21430	*16620 *36640	10920 24070	11620 25620	7000 15430	8090 17840	4950 10910	6040 13320	3680 8110	4990 11000	3020 6660	10.19 (33.4)		
-1.5m (-5.0ft)	kg lb	*10800 *23810	*10800 *23810	*13710 *30230	*13710 *30230	*16830 *37100	10770 23740	11420 25180	6830 15060	7960 17550	4830 10650				5470 12060	3330 7340	9.63 (31.6)	
-3.0m (-10.0ft)	kg lb	*14530 *32030	*14530 *32030	*18410 *40590	*18410 *40590	*16100 *35490	10850 23920	11420 25180	6820 15040	7970 17570	4840 10670				6460 14240	3980 8770	8.74 (28.7)	
-4.5m (-15.0ft)	kg lb			*20220 *44580	*20220 *44580	*14270 *31460	11120 24520	*10560 *23280	7000 15430							*6880 *15170	5430 11970	7.37 (24.2)
-6.0m (-20.0ft)	kg lb					*10450 *23040	*10450 *23040											

(8) 6.45m(21' 2") boom, 4.05m(13' 3") arm equipped with 1.44m³(SAE heaped) bucket and 800mm (32") triple grouser shoe and 6200kg(13670lb) counterweight.











Load point height		Load radius												At max. reach			
		1.5m(5.0ft)		3.0m(10.0ft)		4.5m(15.0ft)		6.0m(20.0ft)		7.5m(25.0ft)		9.0m(30.0ft)		Capacity		Reach	
																m(ft)	
7.5m (25.0ft)	kg lb														*4760 *10490	3560 7850	10.00 (32.8)
6.0m (20.0ft)	kg lb											*4160 *9170	*4160 *9170	4870 10740	3010 6640	10.71 (35.1)	
4.5m (15.0ft)	kg lb								*5710 *12590	*5710 *12590	*5320 *11730	4160 9710	4430 9770	2680 5910	11.13 (36.5)		
3.0m (10.0ft)	kg lb			*16820 *37080	*16820 *37080	*10330 *22770	*10330 *22770	*7880 *17370	*7880 *17370	*6640 *14640	5550 12240	*5940 *13100	3970 8750	4210 9280	2500 5510	11.32 (37.1)	
1.5m (5.0ft)	kg lb			*9930 *21890	*9930 *21890	*13560 *29890	11790 25990	*9590 *21140	7480 16490	*7630 *16820	5200 11460	6140 13540	3760 8290	4160 9170	2440 5380	11.29 (37.0)	
Ground Line	kg lb			*10280 *22660	*10280 *22660	*15690 *34590	10980 24210	*10950 *24140	7000 15430	8050 17750	4900 10800	5960 13140	3590 7910	4280 9440	2510 5530	11.03 (36.2)	
-1.5m (-5.0ft)	kg lb	*9390 *20700	*9390 *20700	*12710 *28020	*12710 *28020	*16580 *36550	10620 23410	11320 24960	6720 14820	7840 17280	4710 10380	5840 12870	3480 7670	4620 10190	2730 6020	10.52 (34.5)	
-3.0m (-10.0ft)	kg lb	*12370 *27270	*12370 *27270	*16100 *35490	*16100 *35490	*16450 *36270	10560 23280	11210 24710	6620 14590	7770 17130	4640 10230	5830 12850	3470 7650	5300 11680	3180 7010	9.72 (31.9)	
-4.5m (-15.0ft)	kg lb	*15810 *34860	*15810 *34860	*20640 *45500	*20640 *45500	*15320 *33770	10720 23630	11220 24740	6690 14750	7850 17310	4720 10410			*6410 *14130	*4080 *8990	8.53 (28.0)	
-6.0m (-20.0ft)	kg lb			*18370 *40500	*18370 *40500	*12770 *28150	11120 24520	*9220 *20330	6990 15410					*6150 *13560	*6150 *13560	6.71 (22.0)	

2) R320NLC-7A

(1) 6.15m(20' 2") boom, 2.2m(7' 3") arm equipped with 1.44m³(SAE heaped) bucket and 600mm (24") triple grouser shoe and 6200kg(13670lb) counterweight.

•  : Rating over-front

•  : Rating over-side or 360 degree

Load point height		Load radius								At max. reach		
		3.0m(10.0ft)		4.5m(15.0ft)		6.0m(20.0ft)		7.5m(25.0ft)		Capacity		Reach
												m(ft)
7.5m (25.0ft)	kg lb									*6910 *15230	4800 10580	7.69 (25.2)
6.0m (20.0ft)	kg lb					*7760 *17110	7360 16230	*7460 *16450	4870 10740	6960 15340	3770 8310	8.61 (28.2)
4.5m (15.0ft)	kg lb			*11210 *24710	11100 24470	*8910 *19640	6970 15370	*7850 *17310	4730 10430	6130 13510	3250 7170	9.16 (30.1)
3.0m (10.0ft)	kg lb			*14450 *31860	9990 22020	*10390 *22910	6490 14310	8440 18610	4510 9940	5770 12720	3000 6610	9.39 (30.8)
1.5m (5.0ft)	kg lb			*16730 *36880	9240 20370	*11700 *25790	6070 13380	8190 18060	4290 9460	5740 12650	2960 6530	9.35 (30.7)
Ground Line	kg lb			*17390 *38340	8970 19780	11490 25530	5830 12850	8030 17700	4150 9150	6050 13340	3120 6880	9.02 (29.6)
-1.5m (-5.0ft)	kg lb	*16010 *35300	*16010 *35300	*16940 *37350	8970 19780	11400 25130	5760 12700	7990 17610	4110 9060	6860 15120	3580 7890	8.37 (27.5)
-3.0m (-10.0ft)	kg lb	*21280 *46910	18510 40810	*15440 *34040	9150 20170	*11470 *25290	5850 12900			*7700 *16980	4600 10140	7.29 (23.9)
-4.5m (-15.0ft)	kg lb	*16550 *36490	*16550 *36490	*12170 *26830	9550 21050							

- Note
1. Lifting capacity are based on SAE J1097 and ISO 10567.
 2. Lifting capacity of the ROBEX series does not exceed 75% of tipping load with the machine on firm, level ground or 87% of full hydraulic capacity.
 3. The load point is a hook located on the back of the bucket.
 4. *indicates load limited by hydraulic capacity.















(2) 6.45m(21' 2") boom, 2.2m(7' 3") arm equipped with 1.44m³(SAE heaped) bucket and 600mm (24") triple grouser shoe and 6200kg(13670lb) counterweight.

Load point height		Load radius								At max. reach		
		3.0m(10.0ft)		4.5m(15.0ft)		6.0m(20.0ft)		7.5m(25.0ft)		Capacity		Reach
												m(ft)
7.5m (25.0ft)	kg lb									*6570 *14480	4300 9480	8.07 (26.5)
6.0m (20.0ft)	kg lb					*7600 *16760	7230 15940	*7100 *15650	4810 10600	6410 14130	3420 7540	8.95 (29.4)
4.5m (15.0ft)	kg lb			*11460 *25260	10740 23680	*8830 *19470	6780 14950	*7610 *16780	4620 10190	5690 12540	2950 6500	9.47 (31.1)
3.0m (10.0ft)	kg lb					*10320 *22750	6260 13800	8290 18280	4370 9630	5360 11820	2730 6020	9.70 (31.8)
1.5m (5.0ft)	kg lb					11520 25400	5840 12870	8030 17700	4140 9130	5340 11770	2690 5930	9.66 (31.7)
Ground Line	kg lb			*17110 *37720	8660 19090	11240 24780	5610 12370	7860 17330	3990 8800	5610 12370	2830 6240	9.34 (30.6)
-1.5m (-5.0ft)	kg lb	*13660 *30120	*13660 *30120	*16560 *36510	8700 19180	11170 24630	5550 12240	7810 17220	3950 8710	6310 13910	3230 7120	8.72 (28.6)
-3.0m (-10.0ft)	kg lb	*20480 *45150	18180 40080	*15160 *33420	8890 19600	11290 24890	5650 12460			*7290 *16070	4100 9040	7.70 (25.3)
-4.5m (-15.0ft)	kg lb	*16460 *36290	*16460 *36290	*12360 *27250	9280 20460							















(3) 6.45m(21' 2") boom, 2.5m(8' 2") arm equipped with 1.44m³(SAE heaped) bucket and 600mm (24") triple grouser shoe and 6200kg(13670lb) counterweight.

Load point height		Load radius										At max. reach		
		3.0m(10.0ft)		4.5m(15.0ft)		6.0m(20.0ft)		7.5m(25.0ft)		9.0m(30.0ft)		Capacity		Reach
														m(ft)
7.5m (25.0ft)	kg lb											*6180 *13620	4070 8970	8.34 (27.4)
6.0m (20.0ft)	kg lb							*6750 *14880	4840 10670			6130 13510	3250 7170	9.19 (30.2)
4.5m (15.0ft)	kg lb			*10750 *23700	*10750 *23700	*8420 *18560	6830 15060	*7310 *16120	4640 10230			5460 12040	2810 6190	9.70 (31.8)
3.0m (10.0ft)	kg lb			*14010 *30890	9650 21270	*9940 *21910	6290 13870	*8080 *17810	4370 9630			5150 11350	2590 5710	9.92 (32.5)
1.5m (5.0ft)	kg lb			*16290 *35910	8840 19490	*11280 *24870	5830 12850	8010 17660	4110 9060	5930 13070	2990 6590	5110 11270	2550 5620	9.88 (32.4)
Ground Line	kg lb			*16990 *37460	8570 18890	11180 24650	5550 12240	7810 17220	3940 8690			5350 11790	2670 5890	9.57 (31.4)
-1.5m (-5.0ft)	kg lb	*14220 *31350	*14220 *31350	*16670 *36750	8560 18870	11080 24430	5460 12040	7740 17060	3880 8550			5970 13160	3020 6660	8.97 (29.4)
-3.0m (-10.0ft)	kg lb	*21440 *47270	17830 39310	*15460 *34080	8730 19250	11160 24600	5530 12190					*7290 *16070	3770 8310	7.98 (26.2)
-4.5m (-15.0ft)	kg lb	*17640 *38890	*17640 *38890	*12990 *28640	9080 20020	*9520 *20990	5820 12830					*6680 *14730	5660 12480	6.42 (21.1)

(4) 6.45m(21' 2") boom, 3.2m(10' 6") arm equipped with 1.44m³(SAE heaped) bucket and 600mm (24") triple grouser shoe and 6200kg(13670lb) counterweight.

Load point height		Load radius												At max. reach		
		1.5m(5.0ft)		3.0m(10.0ft)		4.5m(15.0ft)		6.0m(20.0ft)		7.5m(25.0ft)		9.0m(30.0ft)		Capacity		Reach
																m(ft)
7.5m (25.0ft)	kg lb									*4880 *10760	*4880 *10760			*5500 *12130	3510 7740	9.06 (29.7)
6.0m (20.0ft)	kg lb									*6000 *13230	4970 10960			5470 12060	2860 6310	9.84 (32.3)
4.5m (15.0ft)	kg lb							*7490 *16510	7010 15450	*6640 *14640	4730 10430	*5070 *11180	3290 7250	4920 10850	2490 5490	10.31 (33.8)
3.0m (10.0ft)	kg lb					*12430 *27400	10060 22180	*9090 *20040	6430 14180	*7490 *16510	4420 9740	6100 13450	3140 6920	4650 10250	2300 5070	10.52 (34.5)
1.5m (5.0ft)	kg lb					*15210 *33530	9050 19950	*10610 *23390	5900 13010	8030 17700	4130 9110	5920 13050	2980 6570	4600 10140	2240 4940	10.48 (34.4)
Ground Line	kg lb			*9720 *21430	*9720 *21430	*16620 *36640	8560 18870	11180 24650	5540 12210	7780 17150	3900 8600	5790 12760	2860 6310	4770 10520	2320 5110	10.19 (33.4)
-1.5m (-5.0ft)	kg lb	*10800 *23810	*10800 *23810	*13710 *30230	*13710 *30230	*16830 *37100	8420 18560	10980 24210	5370 11840	7640 16840	3780 8330			5240 11550	2580 5690	9.63 (31.6)
-3.0m (-10.0ft)	kg lb	*14530 *32030	*14530 *32030	*18410 *40590	17300 38140	*16100 *35490	8490 18720	10980 24210	5370 11840	7650 16870	3790 8360			6200 13670	3130 6900	8.74 (28.7)
-4.5m (-15.0ft)	kg lb			*20220 *44580	17820 39290	*14270 *31460	8750 19290	*10560 *23280	5540 12210					*6880 *15170	4340 9570	7.37 (24.2)
-6.0m (-20.0ft)	kg lb					*10450 *23040	9290 20480									

(5) 6.45m(21' 2") boom, 4.05m(13' 3") arm equipped with 1.44m³(SAE heaped) bucket and 600mm (24") triple grouser shoe and 6200kg(13670lb) counterweight.











Load point height		Load radius												At max. reach		
		1.5m(5.0ft)		3.0m(10.0ft)		4.5m(15.0ft)		6.0m(20.0ft)		7.5m(25.0ft)		9.0m(30.0ft)		Capacity		Reach
																m(ft)
7.5m (25.0ft)	kg lb													*4760 *10490	2840 6260	10.00 (32.8)
6.0m (20.0ft)	kg lb												*4160 *9170	3470 7650	4670 10300	10.71 (35.1)
4.5m (15.0ft)	kg lb									*5710 *12590	4820 10630	*5320 *11730	3330 7340	4240 9350	2050 4520	11.13 (36.5)
3.0m (10.0ft)	kg lb			*16820 *37080	*16820 *37080	*10330 *22770	*10330 *22770	*7880 *17370	6610 14570	*6640 *14640	4480 9880	*5940 *13100	3140 6920	4020 8860	1890 4170	11.32 (37.1)
1.5m (5.0ft)	kg lb			*9930 *21890	*9930 *21890	*13560 *29890	9370 20660	*9590 *21140	6000 13230	*7630 *16820	4130 9110	5890 12990	2940 6480	3970 8750	1830 4030	11.29 (37.0)
Ground Line	kg lb			*10280 *22660	*10280 *22660	*15690 *34590	8600 18960	*10950 *24140	5530 12190	7730 17040	3850 8490	5710 12590	2770 6110	4090 9020	1890 4170	11.03 (36.2)
-1.5m (-5.0ft)	kg lb	*9390 *20700	*9390 *20700	*12710 *28020	*12710 *28020	*16580 *36550	8270 18230	10880 23990	5260 11600	7530 16600	3660 8070	5590 12320	2670 5890	4410 9720	2070 4560	10.52 (34.5)
-3.0m (-10.0ft)	kg lb	*12370 *27270	*12370 *27270	*16100 *35490	*16100 *35490	*16450 *36270	8210 18100	10770 23740	5170 11400	7450 16420	3600 7940	5580 12300	2660 5860	5070 11180	2440 5380	9.72 (31.9)
-4.5m (-15.0ft)	kg lb	*15810 *34860	*15810 *34860	*20640 *45500	17110 37720	*15320 *33770	8360 18430	10850 23920	5240 11550	7530 16600	3670 8090			6390 14090	3200 7050	8.53 (28.0)
-6.0m (-20.0ft)	kg lb			*18370 *40500	17820 39290	*12770 *28150	8730 19250	*9220 *20330	5520 12170					*6150 *13560	5060 11160	6.71 (22.0)

3) R320LC-7A HIGH WALKER

(1) 6.15m(20' 2") boom, 2.2m(7' 3") arm equipped with 1.44m³(SAE heaped) bucket and 600mm (24") triple grouser shoe and 6200kg(13670lb) counterweight.

•  : Rating over-front

•  : Rating over-side or 360 degree

Load point height		Load radius								At max. reach		
		3.0m(10.0ft)		4.5m(15.0ft)		6.0m(20.0ft)		7.5m(25.0ft)		Capacity		Reach
												m(ft)
7.5m (25.0ft)	kg lb									*6910 *15230	6330 13960	7.90 (25.9)
6.0m (20.0ft)	kg lb					*7930 *17480	*7930 *17480	*7480 *16490	6770 14930	*6980 *15390	5180 11420	8.74 (28.7)
4.5m (15.0ft)	kg lb			*11810 *26040	*11810 *26040	*9180 *20240	*9180 *20240	*7960 *17550	6600 14550	6780 14950	4610 10160	9.22 (30.2)
3.0m (10.0ft)	kg lb			*15000 *33070	14120 31130	*10660 *23500	9050 19950	*8690 *19160	6360 14020	6460 14240	4360 9610	9.40 (30.8)
1.5m (5.0ft)	kg lb			*16960 *37390	13410 29560	*11890 *26210	8640 19050	9120 20110	6140 13540	6500 14330	4370 9630	9.31 (30.5)
Ground Line	kg lb			*17380 *38320	13190 29080	*12510 *27580	8420 18560	8980 19800	6010 13250	6930 15280	4660 10270	8.93 (29.3)
-1.5m (-5.0ft)	kg lb	*17620 *38850	*17620 *38850	*16750 *36930	13230 29170	*12360 *27250	8370 18450	8970 19780	6000 13230	*7870 *17350	5370 11840	8.21 (26.9)
-3.0m (-10.0ft)	kg lb	*20600 *45420	*20600 *45420	*15000 *33070	13460 29670	*11110 *24490	8520 18780			*7590 *16730	7010 15450	7.03 (23.1)
-4.5m (-15.0ft)	kg lb			*11180 *24650	*11180 *24650							

- Note
1. Lifting capacity are based on SAE J1097 and ISO 10567.
 2. Lifting capacity of the ROBEX series does not exceed 75% of tipping load with the machine on firm, level ground or 87% of full hydraulic capacity.
 3. The load point is a hook located on the back of the bucket.
 4. *indicates load limited by hydraulic capacity.

(2) 6.45m(21' 2") boom, 2.2m(7' 3") arm equipped with 1.44m³(SAE heaped) bucket and 600mm (24") triple grouser shoe and 6200kg(13670lb) counterweight.

Load point height		Load radius								At max. reach		
		3.0m(10.0ft)		4.5m(15.0ft)		6.0m(20.0ft)		7.5m(25.0ft)		Capacity		Reach
												m(ft)
7.5m (25.0ft)	kg lb									*6560 *14460	5750 12680	8.27 (27.1)
6.0m (20.0ft)	kg lb					*7790 *17170	*7790 *17170	*7160 *15790	6690 14750	*6620 *14590	4760 10490	9.07 (29.8)
4.5m (15.0ft)	kg lb			*12070 *26610	*12070 *26610	*9100 *20060	*9100 *20060	*7740 *17060	6480 14290	6310 13910	4250 9370	9.53 (31.3)
3.0m (10.0ft)	kg lb					*10580 *23320	8810 19420	*8490 *18720	6220 13710	6030 13290	4030 8880	9.71 (31.9)
1.5m (5.0ft)	kg lb					*11750 *25900	8400 18520	8960 19750	5990 13210	6060 13360	4040 8910	9.62 (31.6)
Ground Line	kg lb			*17060 *37610	12870 28370	*12310 *27140	8190 18060	8810 19420	5850 12900	6440 14200	4290 9460	9.25 (30.3)
-1.5m (-5.0ft)	kg lb	*15230 *33580	*15230 *33580	*16370 *36090	12940 28530	*12160 *26810	8160 17990	8790 19380	5830 12850	7320 16140	4910 10820	8.56 (28.1)
-3.0m (-10.0ft)	kg lb	*19910 *43890	*19910 *43890	*14770 *32560	13190 29080	*11100 *24470	8300 18300			*7210 *15900	6270 13820	7.45 (24.4)
-4.5m (-15.0ft)	kg lb			*11560 *25490	*11560 *25490							

(3) 6.45m(21' 2") boom, 2.5m(8' 2") arm equipped with 1.44m³(SAE heaped) bucket and 600mm (24") triple grouser shoe and 6200kg(13670lb) counterweight.

Load point height		Load radius									At max. reach			
		3.0m(10.0ft)		4.5m(15.0ft)		6.0m(20.0ft)		7.5m(25.0ft)		9.0m(30.0ft)		Capacity		Reach
7.5m (25.0ft)	kg lb											*6190 *13650	5470 12060	8.53 (28.0)
6.0m (20.0ft)	kg lb							*6830 *15060	6730 14840			*6290 *13870	4560 10050	9.31 (30.5)
4.5m (15.0ft)	kg lb			*11350 *25020	*11350 *25020	*8700 *19180	*8700 *19180	*7440 *16400	6490 14310			6070 13380	4080 8990	9.76 (32.0)
3.0m (10.0ft)	kg lb			*14550 *32080	13750 30310	*10220 *22530	8840 19490	*8230 *18140	6210 13690	6800 14990	4550 10030	5790 12760	3860 8510	9.93 (32.6)
1.5m (5.0ft)	kg lb			*16520 *36420	12990 28640	*11480 *25310	8380 18470	8930 19690	5960 13140			5810 12810	3850 8490	9.84 (32.3)
Ground Line	kg lb			*17000 *37480	12760 28130	*12160 *26810	8130 17920	8750 19290	5790 12760			6140 13540	4080 8990	9.48 (31.1)
-1.5m (-5.0ft)	kg lb	*15490 *34150	*15490 *34150	*16510 *36400	12790 28200	*12150 *26790	8060 17770	8710 19200	5750 12680			6930 15280	4620 10190	8.82 (28.9)
-3.0m (-10.0ft)	kg lb	*20890 *46050	*20890 *46050	*15120 *33330	13010 28680	*11300 *24910	8180 18030					*7250 *15980	5800 12790	7.75 (25.4)
-4.5m (-15.0ft)	kg lb	*16640 *36680	*16640 *36680	*12290 *27090	*12290 *27090									















(4) 6.45m(21' 2") boom, 3.2m(10' 6") arm equipped with 1.44m³(SAE heaped) bucket and 600mm (24") triple grouser shoe and 6200kg(13670lb) counterweight.

Load point height		Load radius												At max. reach		
		1.5m(5.0ft)		3.0m(10.0ft)		4.5m(15.0ft)		6.0m(20.0ft)		7.5m(25.0ft)		9.0m(30.0ft)		Capacity		Reach
																m(ft)
7.5m (25.0ft)	kg lb									*5330 *11750	*5330 *11750			*5520 *12170	4790 10560	9.24 (30.3)
6.0m (20.0ft)	kg lb									*6090 *13430	*6090 *13430			*5650 *12460	4070 8970	9.95 (32.6)
4.5m (15.0ft)	kg lb							*7780 *17150	*7780 *17150	*6790 *14970	6590 14530	*5420 *11950	4740 10450	5490 12100	3660 8070	10.37 (34.0)
3.0m (10.0ft)	kg lb					*13030 *28730	*13030 *28730	*9390 *20700	8980 19800	*7660 *16890	6260 13800	*6720 *14820	4580 10100	5250 11570	3470 7650	10.53 (34.5)
1.5m (5.0ft)	kg lb					*15580 *34350	13170 29030	*10850 *23920	8440 18610	*8510 *18760	5960 13140	6660 14680	4420 9740	5250 11570	3450 7610	10.45 (34.3)
Ground Line	kg lb			*10430 *22990	*10430 *22990	*16740 *26910	12720 28040	*11810 *26040	8100 17860	8710 19200	5750 12680	6530 14400	4310 9500	5490 12100	3610 7960	10.11 (33.2)
-1.5m (-5.0ft)	kg lb	*11470 *25290	*11470 *25290	*14510 *31990	*14510 *31990	*16770 *36970	12620 27820	*12120 *26720	7960 17550	8600 18960	5650 12460			6080 13400	4020 8860	9.50 (31.2)
-3.0m (-10.0ft)	kg lb	*15290 *33710	*15290 *33710	*19420 *42810	*19420 *42810	*15850 *34940	12730 28060	*11690 *25770	7990 17610	8640 19050	5680 12520			*6970 *15370	4860 10710	8.53 (28.0)
-4.5m (-15.0ft)	kg lb			*19390 *42750	*19390 *42750	*13760 *30340	13060 28790	*10140 *22350	8210 18100					*6790 *14970	*6790 *14970	7.03 (23.1)

















(5) 6.45m(21' 2") boom, 4.05m(13' 3") arm equipped with 1.44m³(SAE heaped) bucket and 600mm (24") triple grouser shoe and 6200kg(13670lb) counterweight.

Load point height		Load radius												At max. reach		
		1.5m(5.0ft)		3.0m(10.0ft)		4.5m(15.0ft)		6.0m(20.0ft)		7.5m(25.0ft)		9.0m(30.0ft)		Capacity		Reach
																m(ft)
7.5m (25.0ft)	kg lb											*2760 *6080	*2760 *6080	*4780 *10540	3990 8800	10.16 (33.3)
6.0m (20.0ft)	kg lb											*4400 *9700	*4400 *9700	*4920 *10850	3440 7580	10.81 (35.5)
4.5m (15.0ft)	kg lb									*5870 *12940	*5870 *12940	*5510 *12150	4780 10540	4760 10490	3120 6880	11.19 (36.7)
3.0m (10.0ft)	kg lb			*18490 *40760	*18490 *40760	*10980 *24210	*10980 *24210	*8210 *18100	*8210 *18100	*6830 *15060	6320 13930	*6050 *13340	4580 10100	4570 10080	2960 6530	11.33 (37.2)
1.5m (5.0ft)	kg lb			*9650 *21270	*9650 *21270	*14060 *31000	13470 29700	*9880 *21780	8540 18830	*7800 *17200	5970 13160	*6620 *14590	4370 9630	4550 10030	2930 6460	11.26 (36.9)
Ground Line	kg lb	*7080 *15610	*7080 *15610	*10650 *23480	*10650 *23480	*15940 *35140	12740 28090	*11150 *24580	8080 17810	*8610 *18980	5690 12540	6440 14200	4210 9280	4730 10430	3040 6700	10.95 (35.9)
-1.5m (-5.0ft)	kg lb	*9930 *21890	*9930 *21890	*13280 *29280	*13280 *29280	*16630 *36660	12440 27430	*11820 *26060	7830 17260	8470 18670	5510 12150	6340 13980	4120 9080	5140 11330	3330 7340	10.39 (34.1)
-3.0m (-10.0ft)	kg lb	*12970 *28590	*12970 *28590	*16840 *37130	*16840 *37130	*16320 *35980	12420 27380	*11830 *26080	7760 17110	8420 18560	5470 12060			5960 13140	3900 8600	9.53 (31.3)
-4.5m (-15.0ft)	kg lb	*16520 *36420	*16520 *36420	*21680 *47800	*21680 *47800	*14970 *33000	12630 27840	*10980 *24210	7870 17350	*8220 *18120	5580 12300			*6410 *14130	5070 11180	8.25 (27.1)
-6.0m (-20.0ft)	kg lb			*17270 *38070	*17270 *38070	*12040 *26540	*12040 *26540	*8570 *18890	8230 18140							

















(6) 6.45m(21' 2") boom, 2.5m(8' 2") arm equipped with 1.44m³(SAE heaped) bucket and 710mm (28") double grouser shoe and 6200kg(13670lb) counterweight.

Load point height		Load radius										At max. reach				
		3.0m(10.0ft)		4.5m(15.0ft)		6.0m(20.0ft)		7.5m(25.0ft)		9.0m(30.0ft)		Capacity		Reach		
																m(ft)
7.5m (25.0ft)	kg lb													*6190 *13650	5660 12480	8.53 (28.0)
6.0m (20.0ft)	kg lb							*6830 *15060	*6830 *15060					*6290 *13870	4730 10430	9.31 (30.5)
4.5m (15.0ft)	kg lb			*11350 *25020	*11350 *25020	*8700 *19180	*8700 *19180	*7440 *16400	6730 14840					6310 13910	4240 9350	9.76 (32.0)
3.0m (10.0ft)	kg lb			*14550 *32080	14210 31330	*10220 *22530	9140 20150	*8230 *18140	6440 14200	7070 15590	4740 10450			6040 13320	4020 8860	9.93 (32.6)
1.5m (5.0ft)	kg lb			*16520 *36420	13450 29650	*11480 *25310	8690 19160	*8960 *19750	6190 13650					6060 13360	4020 8860	9.84 (32.3)
Ground Line	kg lb			*17000 *37480	13230 29170	*12160 *26810	8440 18610	9100 20060	6020 13270					6400 14110	4250 9370	9.48 (31.1)
-1.5m (-5.0ft)	kg lb	*15490 *34150	*15490 *34150	*16510 *36400	13260 29230	*12150 *26790	8370 18450	9050 19950	5980 13180					7210 15900	4810 10600	8.82 (28.9)
-3.0m (-10.0ft)	kg lb	*20890 *46050	*20890 *46050	*15120 *33330	13470 29700	*11300 *24910	8480 18700							*7250 *15980	6020 13270	7.75 (25.4)
-4.5m (-15.0ft)	kg lb	*16640 *36680	*16640 *36680	*12290 *27090	*12290 *27090											

(7) 6.45m(21' 2") boom, 3.2m(10' 6") arm equipped with 1.44m³(SAE heaped) bucket and 710mm (28") double grouser shoe and 6200kg(13670lb) counterweight.

Load point height		Load radius										At max. reach						
		1.5m(5.0ft)		3.0m(10.0ft)		4.5m(15.0ft)		6.0m(20.0ft)		7.5m(25.0ft)		9.0m(30.0ft)		Capacity		Reach		
																		m(ft)
7.5m (25.0ft)	kg lb									*5330 *11750	*5330 *11750					*5520 *12170	4970 10960	9.24 (30.3)
6.0m (20.0ft)	kg lb									*6090 *13430	*6090 *13430					*5650 *12460	4230 9330	9.95 (32.6)
4.5m (15.0ft)	kg lb							*7780 *17150	*7780 *17150	*6790 *14970	*6790 *14970	*5420 *11950	4930 10870	5720 12610	3820 8420	10.37 (34.0)		
3.0m (10.0ft)	kg lb					*13030 *28730	*13030 *28730	*9390 *20700	9290 20480	*7660 *16890	6490 14310	*6720 *14820	4770 10520	5480 12080	3620 7980	10.53 (34.5)		
1.5m (5.0ft)	kg lb					*15580 *34350	13640 30070	*10850 *23920	8750 19290	*8510 *18760	6190 13650	6930 15280	4610 10160	5470 12060	3610 7960	10.45 (34.3)		
Ground Line	kg lb			*10430 *22990	*10430 *22990	*16740 *36910	13190 29080	*11810 *26040	8410 18540	9060 19970	5980 13180	6810 15010	4490 9900	5730 12630	3770 8310	10.11 (33.2)		
-1.5m (-5.0ft)	kg lb	*11470 *25290	*11470 *25290	*14510 *31990	*14510 *31990	*16770 *36970	13080 28840	*12120 *26720	8260 18210	8950 19730	5880 12960			6330 13960	4190 9240	9.50 (31.2)		
-3.0m (-10.0ft)	kg lb	*15290 *33710	*15290 *33710	*19420 *42810	*19420 *42810	*15850 *34940	13200 29100	*11690 *25770	8300 18300	*8920 *19670	5920 13050			*6970 *15370	5060 11160	8.53 (28.0)		
-4.5m (-15.0ft)	kg lb			*19390 *42750	*19390 *42750	*13760 *30340	13530 29830	*10140 *22350	8520 18780					*6790 *14970	*6790 *14970	7.03 (23.1)		

(8) 6.45m(21' 2") boom, 3.2m(10' 6") arm equipped with 1.44m³(SAE heaped) bucket and 710mm (28") double grouser shoe and 6200kg(13670lb) counterweight.

Load point height		Load radius												At max. reach				
		1.5m(5.0ft)		3.0m(10.0ft)		4.5m(15.0ft)		6.0m(20.0ft)		7.5m(25.0ft)		9.0m(30.0ft)		Capacity		Reach		
																		m(ft)
7.5m (25.0ft)	kg lb													*2760 *6080	*2760 *6080	*4780 *10540	4150 9150	10.16 (33.3)
6.0m (20.0ft)	kg lb													*4400 *9700	*4400 *9700	*4920 *10850	3590 7910	10.81 (35.5)
4.5m (15.0ft)	kg lb									*5870 *12940	*5870 *12940	*5510 *12150	4960 10930	4970 10960	3260 7190	11.19 (36.7)		
3.0m (10.0ft)	kg lb			*18490 *40760	*18490 *40760	*10980 *24210	*10980 *24210	*8210 *18100	*8210 *18100	*6830 *15060	6550 14440	*6050 *13340	4760 10490	4770 10520	3100 6830	11.33 (37.2)		
1.5m (5.0ft)	kg lb			*9650 *21270	*9650 *21270	*14060 *31000	13940 30730	*9880 *21780	8850 19510	*7800 17200	6200 13670	*6620 *14590	4560 10050	4760 10490	3070 6770	11.26 (36.9)		
Ground Line	kg lb	*7080 *15610	*7080 *15610	*10650 *23480	*10650 *23480	*15940 *35140	13200 29100	*11150 *24580	8390 18500	*8610 *18980	5920 13050	6720 14820	4400 9700	4940 10890	3190 7030	10.95 (35.9)		
-1.5m (-5.0ft)	kg lb	*9930 *21890	*9930 *21890	*13280 *29280	*13280 *29280	*16630 *36660	12910 28460	*11820 *26060	8140 17950	8820 19440	5750 12680	6610 14570	4300 9480	5370 11840	3490 7690	10.39 (34.1)		
-3.0m (-10.0ft)	kg lb	*12970 *28590	*12970 *28590	*16840 *37130	*16840 *37130	*16320 *35980	12890 28420	*11830 *26080	8070 17790	8770 19330	5700 12570			6210 13690	4080 8990	9.53 (31.3)		
-4.5m (-15.0ft)	kg lb	*16520 *36420	*16520 *36420	*21680 *47800	*21680 *47800	*14970 *33000	13090 28860	*10980 *24210	8180 18030	*8220 *18120	5810 12810			*6410 *14130	5280 11640	8.26 (27.1)		
-6.0m (-20.0ft)	kg lb			*17270 *38070	*17270 *38070	*12040 *26540	*12040 *26540	*8570 *18890	8540 18830									

6. BUCKET SELECTION GUIDE

1) GENERAL BUCKET

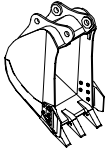
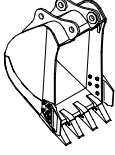
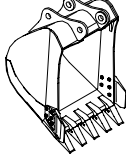
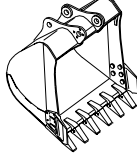
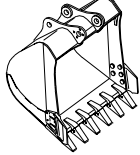
				
0.9m ³ SAE heaped bucket	1.14m ³ SAE heaped bucket	※ 1.44m ³ SAE heaped bucket	1.74m ³ SAE heaped bucket	2.10m ³ SAE heaped bucket

Capacity		Width		Weight	6.45m (21' 2") boom				6.15m(20' 2") boom
SAE heaped	CECE heaped	Without side cutter	With side cutter		2.2m arm (7' 3")	2.5m arm (8' 2")	3.2m arm (10' 6")	4.05m arm (13' 3")	2.2m arm (7' 3")
0.9m ³ (1.18yd ³)	0.8m ³ (1.05yd ³)	950mm (37.4")	1070mm (42.1")	870kg (1920lb)					
1.14m ³ (1.49yd ³)	1.0m ³ (1.31yd ³)	1110mm (43.7")	1230mm (48.4")	980kg (2160lb)					
※ 1.44m ³ (1.88yd ³)	1.25m ³ (1.63yd ³)	1380mm (54.3")	1500mm (59.1")	1110kg (2450lb)					
1.74m ³ (2.28yd ³)	1.5m ³ (1.96yd ³)	1620mm (63.8")	1740mm (68.5")	1230kg (2710lb)					
2.10m ³ (2.75yd ³)	1.8m ³ (2.35yd ³)	1910mm (75.2")	2030mm (79.9")	1370kg (3020lb)					

※ : Standard bucket

 Applicable for materials with density of 2000kg/m³ (3370lb/yd³) or less

 Applicable for materials with density of 1600kg/m³ (2700lb/yd³) or less

 Applicable for materials with density of 1100kg/m³ (1850lb/yd³) or less

2) ROCK AND HEAVY DUTY BUCKET

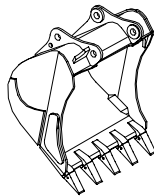
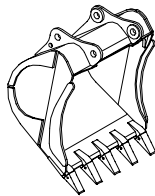
	
◆ 1.44m ³ SAE heaped bucket	◎ 1.44m ³ SAE ◎ 1.73m ³ SAE heaped bucket

Capacity		Width		Weight	6.45m (21' 2") boom				6.15m (20' 2") boom
SAE heaped	CECE heaped	Without side cutter	With side cutter		2.2m arm (7' 3")	2.5m arm (8' 2")	3.2m arm (10' 6")	4.05m arm (13' 3")	2.2m arm (7' 3")
◆ 1.44m ³ (1.88yd ³)	1.25m ³ (1.63yd ³)	1470mm (57.9")	-	1380kg (3040lb)					
◎ 1.44m ³ (1.88yd ³)	1.25m ³ (1.63yd ³)	1470mm (57.9")	-	1470kg (3240lb)					
◎ 1.73m ³ (2.26yd ³)	1.5m ³ (1.96yd ³)	1710mm (67.3")	-	1610kg (3550lb)					

◆ : Heavy duty bucket

◎ : Rock bucket

Applicable for materials with density of 2000kgf/m³ (3370lbf/yd³) or less

Applicable for materials with density of 1600kgf/m³ (2700lbf/yd³) or less

7. UNDERCARRIAGE

1) TRACKS

X-leg type center frame is integrally welded with reinforced box-section track frames. The design includes dry tracks, lubricated rollers, idlers, sprockets, hydraulic track adjusters with shock absorbing springs and assembled track-type tractor shoes with triple grousers.

2) TYPES OF SHOES

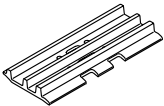
Model	Shapes		Triple grouser			
						
R320LC-7A	Shoe width	mm(in)	600(24)	700(28)	800(32)	900(36)
	Operating weight	kg(lb)	32200(71000)	32800(72300)	33200(73200)	33600(74100)
	Ground pressure	kgf/cm ² (psi)	0.62(8.82)	0.54(7.68)	0.48(6.83)	0.43(6' 11")
	Overall width	mm(ft-in)	3280(10' 9")	3380(11' 1")	3480(11' 5")	3580(11' 9")
R320NLC-7A	Shoe width	mm(in)	600(24)	-	-	-
	Operating weight	kg(lb)	32000(70500)	-	-	-
	Ground pressure	kgf/cm ² (psi)	0.61(8.67)	-	-	-
	Overall width	mm(ft-in)	2990(9' 10")	-	-	-
R320LC-7A HIGH WALKER	Shoe width	mm(in)	600(24)	700(28)	800(32)	Double Grouser 710(28)
	Operating weight	kg(lb)	34700(76500)	35300(77800)	35700(78700)	35900(79100)
	Ground pressure	kgf/cm ² (psi)	0.67(9.53)	0.58(8.25)	0.51(7.25)	0.58(8.25)
	Overall width	mm(ft-in)	3470(11' 5")	3570(11' 9")	3670(12' 0")	3580(11' 9")

3) NUMBER OF ROLLERS AND SHOES ON EACH SIDE

Item	Quantity
Carrier rollers	2EA
Track rollers	9EA
Track shoes	48EA

4) SELECTION OF TRACK SHOE

Suitable track shoes should be selected according to operating conditions.

Method of selecting shoes

Confirm the category from the list of applications in **table 2**, then use **table 1** to select the shoe. Wide shoes (Categories B and C) have limitations on applications. Before using wide shoes, check the precautions, then investigate and study the operating conditions to confirm if these shoes are suitable.

Select the narrowest shoe possible to meet the required flotation and ground pressure. Application of wider shoes than recommendations will cause unexpected problem such as bending of shoes, crack of link, breakage of pin, loosening of shoe bolts and the other various problems.

※ **Table 1**

Track shoe	Specification	Category
600mm triple grouser	Standard	A
700mm triple grouser	Option	B
710mm double grouser	Option	B
800mm triple grouser	Option	C
900mm triple grouser	Option	C

※ **Table 2**

Category	Applications	Precautions
A	Rocky ground, river beds, normal soil	<ul style="list-style-type: none"> • Travel at low speed on rough ground with large obstacles such as boulders or fallen trees
B	Normal soil, soft ground	<ul style="list-style-type: none"> • These shoes cannot be used on rough ground with large obstacles such as boulders or fallen trees • Travel at high speed only on flat ground • Travel slowly at low speed if it is impossible to avoid going over obstacles
C	Extremely soft ground (Swampy ground)	<ul style="list-style-type: none"> • Use the shoes only in the conditions that the machine sinks and it is impossible to use the shoes of category A or B • These shoes cannot be used on rough ground with large obstacles such as boulders or fallen trees • Travel at high speed only on flat ground • Travel slowly at low speed if it is impossible to avoid going over obstacles

8. SPECIFICATIONS FOR MAJOR COMPONENTS

1) ENGINE

Item	Specification
Model	Cummins QSC
Type	4-cycle turbocharged charger air cooled diesel engine
Cooling method	Water cooling
Number of cylinders and arrangement	6 cylinders, in-line
Firing order	1-5-3-6-2-4
Combustion chamber type	Direct injection type
Cylinder bore × stroke	114 × 135mm(4.49" × 5.32")
Piston displacement	8300cc(505cu in)
Compression ratio	17.5 : 1
Rated gross horse power(SAE J1995)	258Hp at 1750rpm(193kW at 1750rpm)
Maximum torque	114.8kgf · m(830lbf · ft) at 1500rpm
Engine oil quantity	35 l (9.2U.S. gal)
Dry weight	723kg(1594lb)
High idling speed	1750+ 50rpm
Low idling speed	700± 50rpm
Rated fuel consumption	166.7g/Hp · hr at 1750rpm
Starting motor	Denso(24V-7.5kW)
Alternator	Delco Remy 24V-50A
Battery	2 × 12V × 160Ah

2) MAIN PUMP

Item	Specification
Type	Variable displacement tandem axis piston pumps
Capacity	2 × 148.6cc/rev
Maximum pressure	330kgf/cm ² (4690psi)[360kgf/cm ² (5120psi)]
Rated oil flow	2 × 260 l /min (68.7U.S. gpm/ 57.2U.K. gpm)
Rated speed	1750rpm

[]: Power boost

3) GEAR PUMP

Item	Specification
Type	Fixed displacement gear pump single stage
Capacity	15cc/rev
Maximum pressure	35kgf/cm ² (500psi)
Rated oil flow	27 l /min(7.1U.S. gpm/6.0U.K. gpm)

4) MAIN CONTROL VALVE

Item	Specification
Type	9 spools
Operating method	Hydraulic pilot system
Main relief valve pressure	330kgf/cm ² (4690psi) [360kgf/cm ² (5120psi)]
Overload relief valve pressure	390kgf/cm ² (5550psi)

[]: Power boost

5) SWING MOTOR

Item	Specification
Type	Axial piston motor
Capacity	169.4cc/rev
Relief pressure	265kgf/cm ² (3770psi)
Braking system	Automatic, spring applied hydraulic released
Braking torque	70kgf · m(505lbf · ft)
Brake release pressure	26kgf/cm ² (370psi)
Reduction gear type	2 - stage planetary
Swing speed	9.1rpm

6) TRAVEL MOTOR

Item	Specification
Type	Variable displacement axial piston motor
Relief pressure	330kgf/cm ² (4700psi)
Capacity(max / min)	88.5/154.8cc/rev
Reduction gear type	3-stage planetary
Braking system	Automatic, spring applied hydraulic released
Brake release pressure	9kgf/cm ² (128psi)
Braking torque	40kgf · m(290lbf · ft)

7) REMOTE CONTROL VALVE

Item		Specification
Type		Pressure reducing type
Operating pressure	Minimum	6.5kgf/cm ² (92psi)
	Maximum	26kgf/cm ² (370psi)
Single operation stroke	Lever	61mm(2.4in)
	Pedal	123mm(4.84in)

8) CYLINDER

Item		Specification
Boom cylinder	Bore dia × Rod dia × Stroke	∅ 150 × ∅ 105 × 1480mm
	Cushion	Extend only
Arm cylinder	Bore dia × Rod dia × Stroke	∅ 160 × ∅ 110 × 1685mm
	Cushion	Extend and retract
Bucket cylinder	Bore dia × Rod dia × Stroke	∅ 140 × ∅ 100 × 1285mm
	Cushion	Extend only

※ Discoloration of cylinder rod can occur when the friction reduction additive of lubrication oil spreads on the rod surface.

※ Discoloration does not cause any harmful effect on the cylinder performance.

9) SHOE

Item		Width	Ground pressure	Link quantity	Overall width
R320LC-7A	Standard	☆600mm(24")	0.62kgf/cm ² (8.82psi)	48	3280mm(10' 9")
	Option	☆700mm(28")	0.54kgf/cm ² (7.68psi)	48	3380mm(11' 1")
		☆800mm(32")	0.48kgf/cm ² (6.83psi)	48	3480mm(11' 5")
		☆900mm(36")	0.43kgf/cm ² (6.11psi)	48	3580mm(11' 9")
R320NLC-7A	Standard	☆600mm(24")	0.61kgf/cm ² (8.67psi)	48	2990mm(9' 10")
R320LC-7A H/WALKER	Standard	☆600mm(24")	0.67kgf/cm ² (9.53psi)	48	3470mm(11' 5")
	Option	☆700mm(28")	0.58kgf/cm ² (8.25psi)	48	3570mm(11' 9")
		☆800mm(32")	0.51kgf/cm ² (7.25psi)	48	3670mm(12' 0")
		★710mm(28")	0.58kgf/cm ² (8.25psi)	48	3580mm(11' 9")

☆ : Triple grouser

★ : Double grouser

10) BUCKET

Item		Capacity		Tooth quantity	Width	
		SAE heaped	CECE heaped		Without side cutter	With side cutter
R320LC-7A R320NLC-7A H/WALKER	Standard	1.44m ³ (1.88yd ³)	1.25m ³ (1.63yd ³)	5	1380mm(54.3")	1500mm(59.1")
	Option	0.9m ³ (1.18yd ³)	0.8m ³ (1.05yd ³)	3	950mm(37.4")	1070mm(42.1")
		1.14m ³ (1.49yd ³)	1.0m ³ (1.31yd ³)	4	1110mm(43.7")	1230mm(48.4")
		1.74m ³ (2.28yd ³)	1.5m ³ (1.96yd ³)	5	1620mm(63.8")	1740mm(68.5")
		2.10m ³ (2.75yd ³)	1.8m ³ (2.35yd ³)	5	1910mm(75.2")	2030mm(79.9")
		◆1.44m ³ (1.88yd ³)	1.25m ³ (1.63yd ³)	5	1470mm(57.9")	-
		◎1.44m ³ (1.88yd ³)	1.25m ³ (1.63yd ³)	5	1470mm(57.9")	-
		◎1.73m ³ (2.26yd ³)	1.5m ³ (1.96yd ³)	5	1710mm(67.3")	-

◆ : Heavy duty bucket

◎ : Rock bucket(Esco type)

9. RECOMMENDED OILS

Use only oils listed below or equivalent.

Do not mix different brand oil.

Service point	Kind of fluid	Capacity l (U.S. gal)	Ambient temperature °C (°F)								
			-20 (-4)	-10 (14)	0 (32)	10 (50)	20 (68)	30 (86)	40 (104)		
Engine oil pan	Engine oil	35(9.2)					SAE 30				
			SAE 10W								
			SAE 10W-30								
							SAE 15W-40				
Swing drive	Gear oil	11(2.9)					SAE 85W-140				
Final drive		5.5×2 (1.5×2)									
Hydraulic tank	Hydraulic oil	Tank; 210(55.5) System; 320(84.5)	ISO VG 32								
			ISO VG 46								
						ISO VG 68					
Fuel tank	Diesel fuel	480(127)	ASTM D975 NO.1								
							ASTM D975 NO.2				
Fitting (Grease nipple)	Grease	As required	NLGI NO.1								
							NLGI NO.2				
Radiator (Reservoir tank)	Mixture of antifreeze and water 50 : 50	45(12)	Ethylene glycol base permanent type								

SAE : Society of Automotive Engineers

API : American Petroleum Institute

ISO : International Organization for Standardization

NLGI : National Lubricating Grease Institute

ASTM : American Society of Testing and Material