

GROUP 6 AUTOMATIC WARMING UP FUNCTION

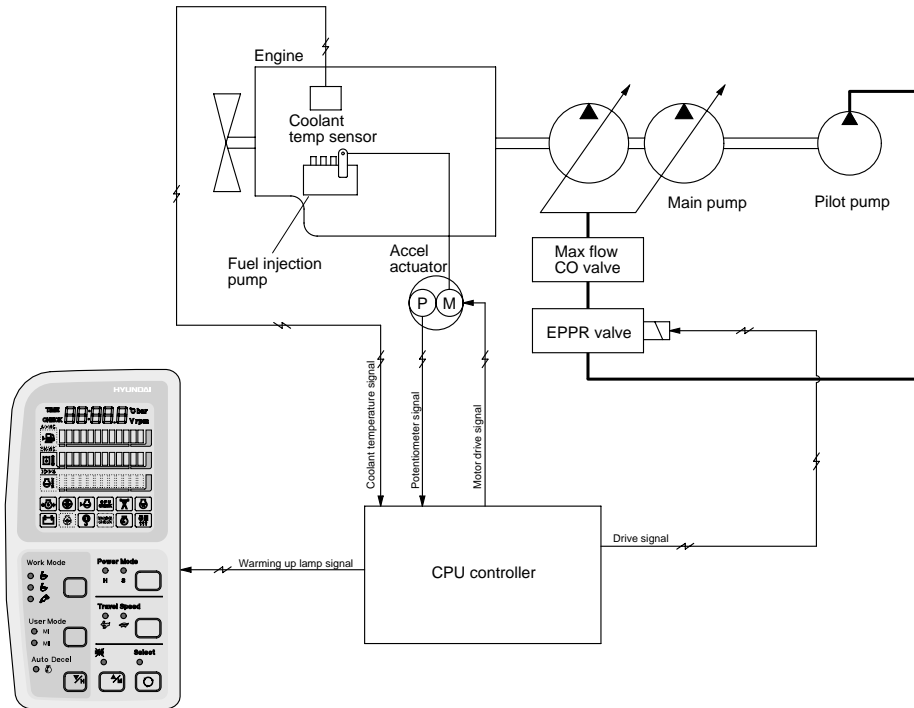

21075MS08

1. CPU controller reads engine coolant temperature through the temperature sensor, and if the coolant temperature is less than 30°C, it increases the engine speed from key start rpm to 1100rpm. At this time the mode does not change.
2. In case of the coolant temperature increases up to 30°C, the engine speed is decreased to key start speed. And if an operator changes mode set during the warming up function, the CPU controller cancels the automatic warming up function.

3. LOGIC TABLE

Description	Condition	Function
Actuated	- Coolant temperature : Less than 30°C(After engine run) - Accel dial position is under 3	- Mode : Default(S mode) - Warming up time : 10 minutes(Max) - Warming up lamp : ON
Canceled	- Coolant temperature : Above 30°C - Warming up time : Above 10 minutes - Changed mode set by operator - Increase engine speed by rotating accel dial clockwise If any of the above conditions is applicable, the automatic warming up function is canceled	- Default mode - Default mode - Changed mode
Warming up lamp	- Coolant temperature : Above 30°C	- Warming up lamp : OFF