

GROUP 2 MAJOR COMPONENT

1. MAIN PUMP

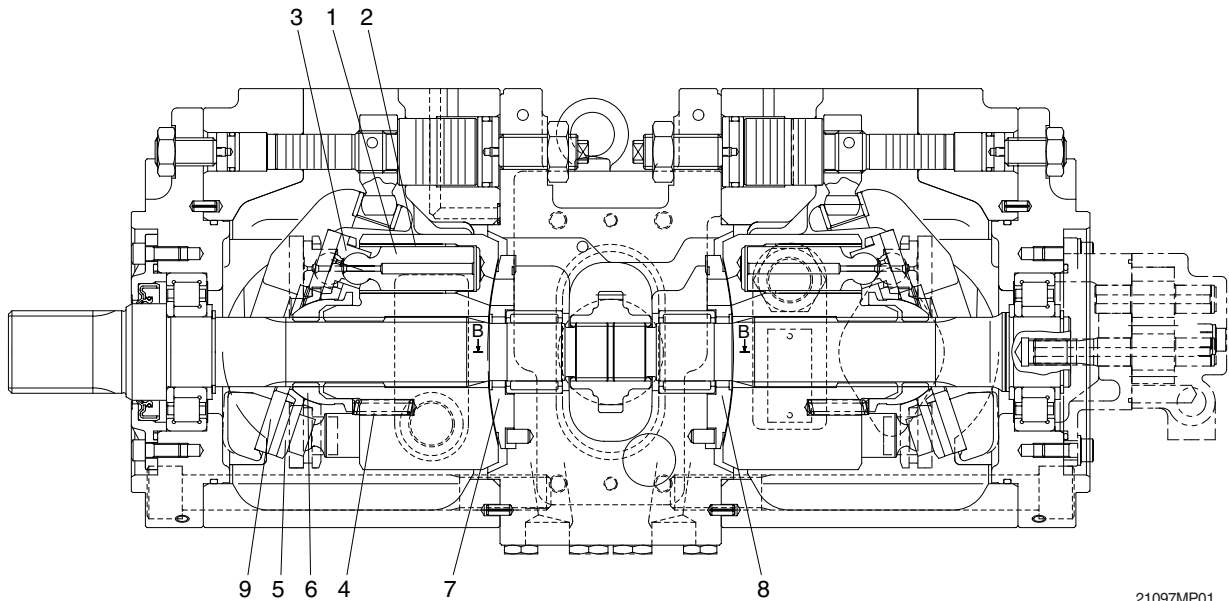

21097MP01

Part name & inspection item		Standard dimension	Recommended replacement value	Counter measures
Clearance between piston (1) & cylinder bore (2) (D-d)		0.039	0.067	Replace piston or cylinder.
Play between piston (1) & shoe caulking section (3) (δ)		0-0.1	0.3	Replace assembly of piston & shoe.
Thickness of shoe (t)		4.9	4.7	
Free height of cylinder spring (4) (L)		41.1	40.3	Replace cylinder spring.
Combined height of set plate (5) & spherical bushing (6) (H-h)		23.0	22.0	Replace retainer or set plate.
Surface roughness for valve plate (sliding face) (7,8), swash plate (shoe plate area) (9), & cylinder (2) (sliding face)	Surface roughness necessary to be corrected	3z		Lapping
	Standard surface roughness (corrected value)	0.4z or lower		

2. MAIN CONTROL VALVE

Part name	Inspection item	Criteria & measure
Casing	<ul style="list-style-type: none"> Existence of scratches, rust or corrosion. 	<ul style="list-style-type: none"> In case of damage in following section, replace casing. <ul style="list-style-type: none"> Sliding sections of casing hole and spool, especially land sections applied with held pressure. Seal pocket section where spool is inserted. Sealing section of port where O-ring contacts. Sealing section of each relief valve for main and port. Sealing section of plug. Other damages that may damage normal function.
Spool	<ul style="list-style-type: none"> Existence of scratch, gnawing, rusting or corrosion. O-ring seal sections at both ends. Insert spool into casing hole, rotate and reciprocate it. 	<ul style="list-style-type: none"> Replacement when its outside sliding section has scratch (especially on seals-contacting section). Replacement when its sliding section has scratch. Correction or replacement when O-ring is damaged or when spool does not move smoothly.
Poppet	<ul style="list-style-type: none"> Damage of spring Damage of poppet Insert poppet into casing and function it. 	<ul style="list-style-type: none"> Replacement. Correction or replacement when sealing is incomplete. Normal when it can function lightly and smoothly without sticking.
Spring and related parts	<ul style="list-style-type: none"> Rusting, corrosion, deformation or breakage of spring, spring seat, plug or cover. 	<ul style="list-style-type: none"> Replacement for significant damage.
Around seal for spool	<ul style="list-style-type: none"> External oil leakage. Rusting, corrosion or deformation of seal plate. 	<ul style="list-style-type: none"> Correction or replacement. Correction or replacement.
Main relief valve, port relief valve & posi-nega conversion valve	<ul style="list-style-type: none"> External rusting or damage. Contacting face of valve seat. Contacting face of poppet. O-rings and back up rings. 	<ul style="list-style-type: none"> Replacement. Replacement when damaged. Replacement when damaged. Replacement in principle.

3. SWING DEVICE

1) WEARING PARTS

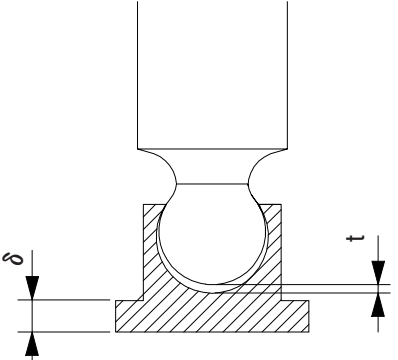
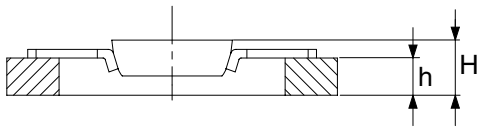
Inspection item	Standard dimension	Recommended replacement value	Counter measures
Clearance between piston and cylinder block bore	0.028	0.058	Replace piston or cylinder block
Play between piston and shoe caulking section (δ)	0	0.3	Replace assembly of piston and shoe
Thickness of shoe (t)	5.5	5.3	Replace assembly of piston and shoe
Combined height of retainer plate and spherical bushing (H)	6.5	6.0	Replace set of retainer plate and spherical bushing
Thickness of friction plate (h)	4.0	3.6	Replace
 <p style="text-align: right; font-size: small;">2507A7MS04</p>		 <p style="text-align: right; font-size: small;">2507A7MS05</p>	

2) SLIDING PARTS

Part name	Standard roughness	Allowable roughness	Remark
Shoe	0.8-Z (Ra=0.2) (LAPPING)	3-Z (Ra=0.8)	
Shoe plate	0.4-Z (Ra=0.1) (LAPPING)	3-Z (Ra=0.8)	
Cylinder	1.6-Z (Ra=0.4) (LAPPING)	12.5-Z (Ra=3.2)	
Valve plate	0.8-Z (Ra=0.2) (LAPPING)	6.3-Z (Ra=1.6)	

4. TRAVEL MOTOR

Problem		Cause	Remedy
Does not start	Pressure is not developed	<ul style="list-style-type: none"> · Pump failure · Control valve malfunction 	<ul style="list-style-type: none"> · Check if action other than traveling is available. If faulty, repair. · Check if spool moves correctly. Repair if necessary.
	Pressure in developed	<ul style="list-style-type: none"> · Brake valve failure -Sleeve stick -Check valve stick · Motor failure -Valve seat seizure · Gear broken and fragment locked · Overloaded 	<ul style="list-style-type: none"> · Replace brake valve · Replace -Check hydraulic oil for contamination · Replace reduction gear · Reduce load
Oil leakage	Leakage from engaging surfaces	<ul style="list-style-type: none"> · Scratch on engaging surfaces · Loosening by poor bolt tightening 	<ul style="list-style-type: none"> · Correct surfaces by oilstone or sandpaper or replace · Check after retightening
	Leakage from casing	<ul style="list-style-type: none"> · Plug loosened · Crack formed by stone 	<ul style="list-style-type: none"> · Retighten · Replace reduction gear
	Leakage from floating seal	<ul style="list-style-type: none"> · Sliding surfaces worn · Creep on O-ring 	<ul style="list-style-type: none"> · Replace reduction gear · Replace floating seal
	Leakage from hydraulic motor	<ul style="list-style-type: none"> · Bolt loosened · O-ring damaged · Sealing surface scratched 	<ul style="list-style-type: none"> · Tighten properly · Replace O-ring · Correct by oilstone or sandpaper
Coasts on slope excessively		<ul style="list-style-type: none"> · Poor volumetric efficiency of hydraulic motor · Increase of internal leakage of brake valve · Parking brake not actuated -Spring breakage -Wear of friction plate 	<ul style="list-style-type: none"> · Replace hydraulic motor · Replace brake valve · Replace spring · Replace parking brake
Excessive temperature on reduction gear case		<ul style="list-style-type: none"> · Pitting on bearing · Lack of gear oil · Hydraulic oil introduced to gear case 	<ul style="list-style-type: none"> · Replace reduction gear · Supply gear oil properly · Check motor and replace oil seal
Meanders	Meanders at low pressure	<ul style="list-style-type: none"> · Delivery rate is different between right and left · Motor drain rate is different between right and left 	<ul style="list-style-type: none"> · Repair pump · Replace motor
	Meanders at high pressure	<ul style="list-style-type: none"> · Delivery rate is different between right and left · Motor drain rate is different between right and left 	<ul style="list-style-type: none"> · Repair regulator or pump · Replace motor
	Meanders at high pressure	<ul style="list-style-type: none"> · Relief pressure dropped at right and left brake valve · Main relief pressure dropped at right or left of control valve 	<ul style="list-style-type: none"> · Replace brake valve · Replace main relief valve
Pump delivery is poor		<ul style="list-style-type: none"> · Regulator operation poor · External leakage of pump is excessive 	<ul style="list-style-type: none"> · Repair regulator · Repair pump
External leakage of motor is excessive		-	<ul style="list-style-type: none"> · Replace motor

5. RCV LEVER

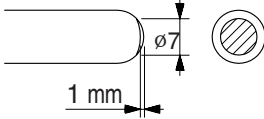
Maintenance check item	Criteria	Remark
Leakage	The valve is to be replaced when the leakage becomes more than 1000 cc/m at neutral handle position, or more than 2000 cc/m during operation.	Conditions : Primary pressure : 40 kgf/cm ² Oil viscosity : 23 cSt
Spool	This is to be replaced when the sliding surface has worn more than 10 μ m, compared with the non-sliding surface.	The leakage at the left condition is estimated to be nearly equal to the above leakage.
Push rod	 <p>This is to be replaced when the top end has worn more than 1 mm.</p>	
Play at operating section	The pin, shaft, and joint of the operating section are to be replaced when their plays become more than 2 mm due to wears or so on.	When a play is due to looseness of a tightened section, adjust it.
Operation stability	When abnormal noises, hunting, primary pressure drop, etc. are generated during operation, and these cannot be remedied, referring to section 6. Troubleshooting, replace the related parts.	

- Notes
1. It is desirable to replace seal materials, such as O-rings, every disassembling. However, they may be reused, after being confirmed to be free of damage.
 2. When loosening the hexagon socket head cap screw (125), replace the seal washers (121) without fail.

6. RCV PEDAL

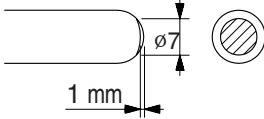
Maintenance check item	Criteria	Remark
Leakage	The valve is to be replaced when the leakage effect to the system. For example, the primary pressure drop.	Conditions : Primary pressure : 40 kgf/cm ² Oil viscosity : 23 cSt
Spool	This is to be replaced when the sliding surface has worn more than 10 μ m, compared with the non-sliding surface.	The leakage at the left condition is estimated to be nearly equal to the above leakage.
Push rod	 <p>This is to be replaced when the top end has worn more than 1 mm.</p>	
Play at operating section	The pin, shaft, and joint of the operating section are to be replaced when their plays become more than 2 mm due to wears or so on.	When a play is due to looseness of a tightened section, adjust it.
Operation stability	When abnormal noises, hunting, primary pressure drop, etc. are generated during operation, and these cannot be remedied, referring to section 6. Troubleshooting, replace the related parts.	

Notes 1. It is desirable to replace seal materials, such as O-rings, every disassembling. However, they may be reused, after being confirmed to be free of damage.

7. TURNING JOINT

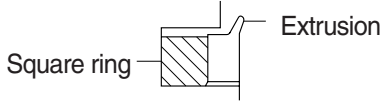
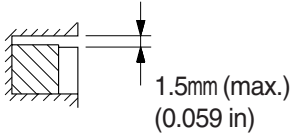
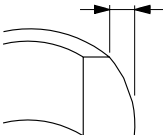
Part name		Maintenance standards	Remedy
Body, Stem	Sliding surface with sealing sections.	Plating worn or peeled due to seizure or contamination.	Replace
	Sliding surface between body and stem other than sealing section.	• Worn abnormality or damaged more than 0.1 mm (0.0039 in) in depth due to seizure contamination.	Replace
		• Damaged more than 0.1 mm (0.0039 in) in depth.	Smooth with oilstone.
	Sliding surface with thrust plate.	• Worn more than 0.5 mm (0.02 in) or abnormality.	Replace
• Worn less than 0.5 mm (0.02 in).		Smooth	
• Damage due to seizure or contamination remediable within wear limit (0.5 mm) (0.02 in).		Smooth	
Cover	Sliding surface with thrust plate.	• Worn more than 0.5 mm (0.02 in) or abnormality.	Replace
		• Worn less than 0.5 mm (0.02 in).	Smooth
		• Damage due to seizure or contamination remediable within wear limit (0.5 mm) (0.02 in).	Replace
Seal set	-	<ul style="list-style-type: none"> • Extruded excessively from seal groove square ring. 	Replace
	-	<ul style="list-style-type: none"> • Slipper ring 1.5 mm (0.059 in) narrower than seal groove, or narrower than back ring. 	Replace
	-	<ul style="list-style-type: none"> • Worn more than 0.5 mm (0.02 in) ~ 1.5 mm (MAX.) (0.059 in) 	Replace

8. CYLINDER

Part name	Inspecting section	Inspection item	Remedy
Piston rod	· Neck of rod pin	· Presence of crack	· Replace
	· Weld on rod hub	· Presence of crack	· Replace
	· Stepped part to which piston is attached.	· Presence of crack	· Replace
	· Threads	· Presence of crack	· Recondition or replace
	· Plated surface	· Plating is not worn off to base metal.	· Replace or replate
		· Rust is not present on plating. · Scratches are not present.	· Replace or replate · Recondition, replate or replace
	· Rod	· Wear of O.D.	· Recondition, replate or replace
· Bushing at mounting part	· Wear of I.D.	· Replace	
Cylinder tube	· Weld on bottom	· Presence of crack	· Replace
	· Weld on head	· Presence of crack	· Replace
	· Weld on hub	· Presence of crack	· Replace
	· Tube interior	· Presence of faults	· Replace if oil leak is seen
	· Bushing at mounting part	· Wear on inner surface	· Replace
Gland	· Bushing	· Flaw on inner surface	· Replace if flaw is deeper than coating