

GROUP 7 TRANSMISSION

1. REMOVAL AND INSTALL

1) REMOVAL

- (1) Swing the work equipment 90° and lower it completely to the ground.
- (2) Operate the control levers and pedals several times to release the remaining pressure in the hydraulic piping.
- (3) Loosen the breather slowly to release the pressure inside the hydraulic tank.

▲ Escaping fluid under pressure can penetrate the skin causing serious injury.

ⓘ When pipes and hoses are disconnected, the oil inside the piping will flow out, so catch it in oil pan.

- (4) Remove the propeller shaft mounting nuts(3).

ⓘ Tightening torque : 5.9 ; 0.6kgf ; /m
(42.7 ; 4.3lbf ; /ft)

- (5) Remove the travel motor mounting bolt(2).

ⓘ Tightening torque : 29.6 ; 3.2kgf ; /m
(214 ; 23.1lbf ; /ft)

- (6) Remove the hoses.

ⓘ Fit blind plugs to the disconnected hoses.

- (7) Remove the mounting bolts(2), then remove the transmission device assembly.

ⓘ Weight : 130kg(290lb)

ⓘ Tightening torque : 39.0 ; 4.2kgf ; /m
(282 ; 30.4lbf ; /ft)

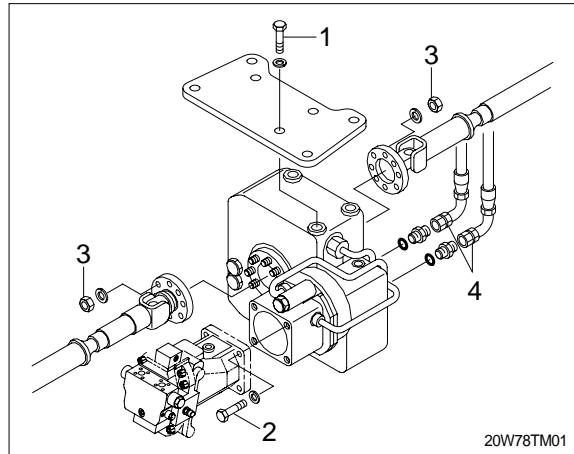

2) INSTALL

- (1) Carry out installation in the reverse order to removal.

- (2) Bleed the air from the transmission.

⊠ Remove the air vent plug.

⊠ Pour in hydraulic oil until it overflows from the port.

⊠ Tighten plug lightly.

⊠ Start the engine, run at low idling, and check oil come out from plug.

⊠ Tighten plug fully.

- (3) Confirm the hydraulic oil level and check the hydraulic oil leak or not.

2. GENERAL INSTRUCTIONS

1) GENERAL WORKING INSTRUCTIONS

- (1) This manual has been developed for the skilled serviceman, trained by manufacturer.
- (2) During all operations, pay attention to cleanliness and skilled working.
Therefore, transmission removed from the machine must be cleaned prior to open them.
- (3) We assume that the special tools, specified by manufacturer, will be used.
The special tools are available from manufacturer.
- (4) After the disassembly, all components must be cleaned, especially corners, cavities and recesses of housing and covers.
- (5) The old sealing compound must be carefully removed.
- (6) Check lubricating holes, grooves and pipes for free passage. They must be free of residues, foreign material or protective compounds.
- (7) The latter refers especially to new parts.
- (8) Parts which have been inevitably damaged in a disassembly operation, must be generally replaced by new ones, e.g. rotary seal rings, O-rings, U-section rings, cap boots, protective caps etc..
- (9) Components such as roller bearings, thrust washers, synchronizing parts etc. which are subject to normal wear in automotive operation, must be checked by the skilled Serviceman.
He will decide if the parts can be reused.
- (10) For the heating of bearings etc., hot plates, rod heaters or heating furnaces must be used.
- (11) Never heat parts directly with the flame. An auxiliary solution would be to immerse the bearing in a vessel filled with oil, which is then heated with the flame.
In this way, damage to the bearings could be avoided.
- (12) Ball bearings, covers, flanges and parts like that must be heated to about 90 to 100 °C.
- (13) Hot-mounted parts must be reset after cooling in order to assure a proper contact.
- (14) Before pressing shafts, bearings etc. in position, both parts must be lubricated.
- (15) During to reassembly, all specified adjustment values, testing specifications and tightening torque must be respected.
- (16) After the repair, units are filled up with oil.
- (17) After the oil filling, the oil level plugs and oil drain plugs must be tightened to the specified tightening torque.

2) IMPORTANT INSTRUCTIONS CONCERNING THE LABOUR SAFETY

- (1) In principle, repairers are themselves responsible for the labour safety.
- (2) The observance of all valid safety regulations and legal rules is a precondition to prevent damage to individuals and products during the maintenance and repair operations.
- (3) Before starting the work, the repairers have to make themselves familiar with these regulations.
- (4) The proper repair of these products requires especially trained personnel.
- (5) The repairer himself is obliged to provide for the training.

3) LUBRICANT SPECIFICATIONS

- (1) Engine oil : API CD/CE/CF/SF/SG
MIL-L-2104 C/D/E
MIL-L-4615 C/D/E
- (2) SAE 10W-30, 15W-40

3. DISASSEMBLY

1) REMOVE SHIFTING CLUTCHES

- (1) Fasten gearbox in the assembly car.
Loosen screw plug(Arrow) and drain oil.

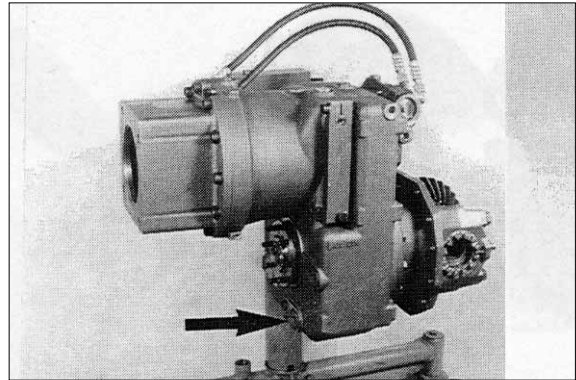

20W78TM301

- (2) Remove the two lines, see Arrows.

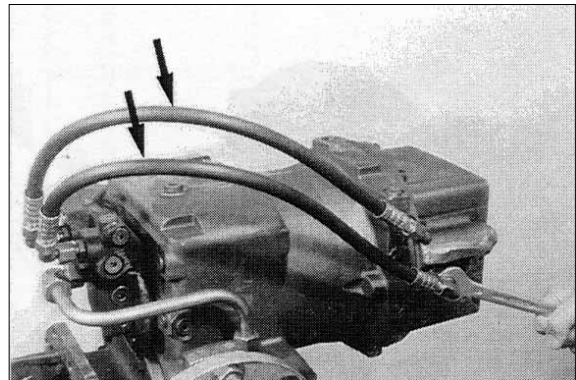

20W78TM02

- (3) Remove locking screw, see Arrow.

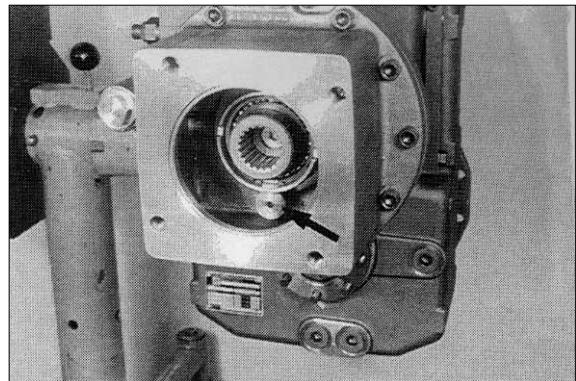

20W78TM03

- (4) Squeeze out snap ring(Arrow).

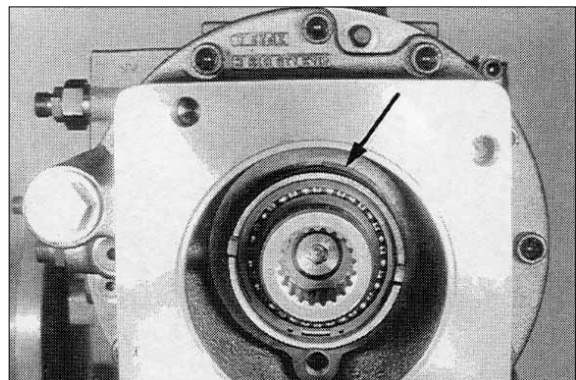

20W78TM04

- (5) Loosen socket head screws evenly, install two adjusting screws and separate drive casing from the gearbox.
i Drive casing is spring-loaded.

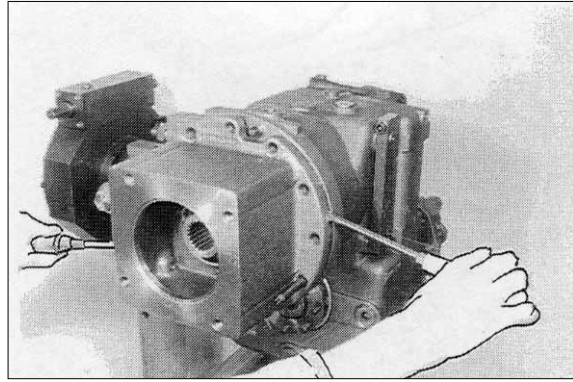

20W78TM05

- (6) Remove the two cup springs.

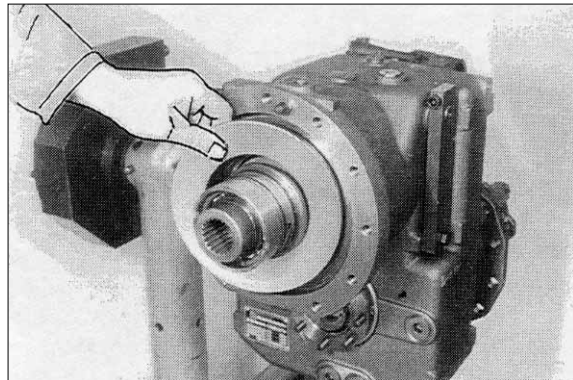

20W78TM06

- (7) Close supply line(Arrow) and press piston out of the housing bore, using compressed air.

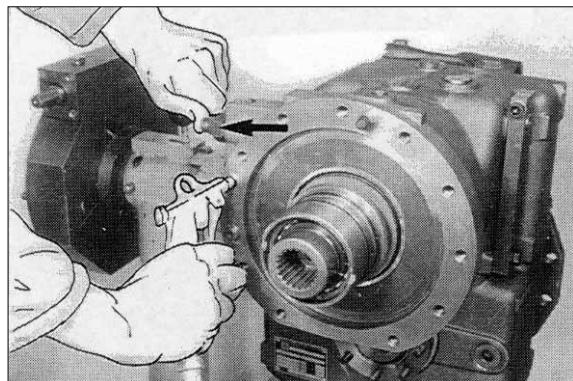

20W78TM07

- (8) Remove screw plug and breather(Arrows).

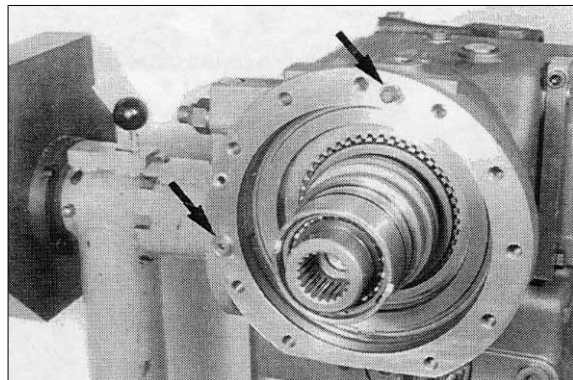

20W78TM08

(9) Remove seal ring and back-up ring from the ring groove of the housing(Arrow).

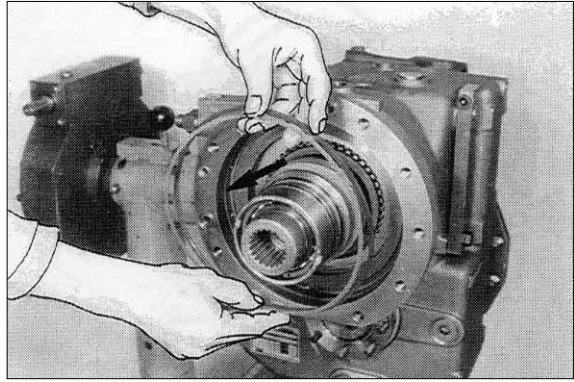

20W78TM09

(10) Squeeze out snap ring.

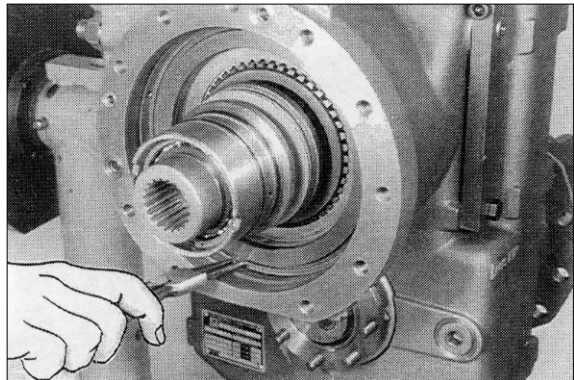

20W78TM10

(11) Pull gasket out of the housing bore, using offset screw driver.

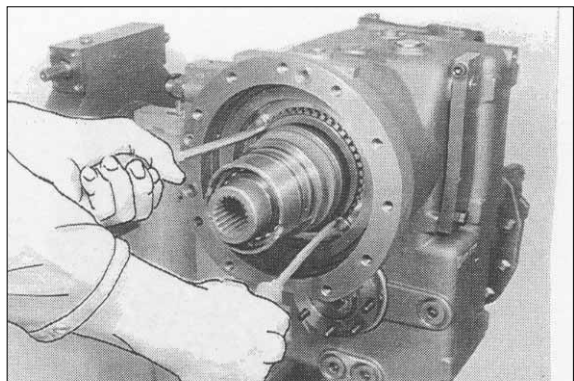

20W78TM11

(12) Remove O-ring(Arrow).

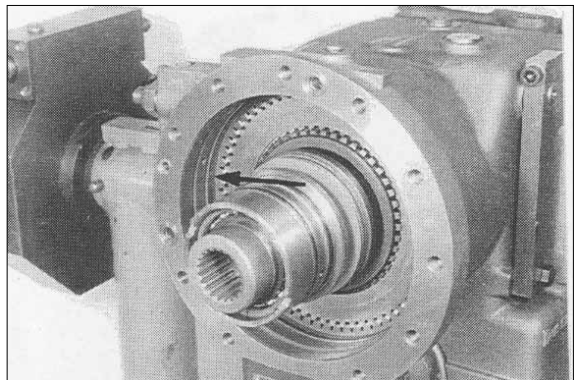

20W78TM12

(13) Remove plate pack and backing plate.

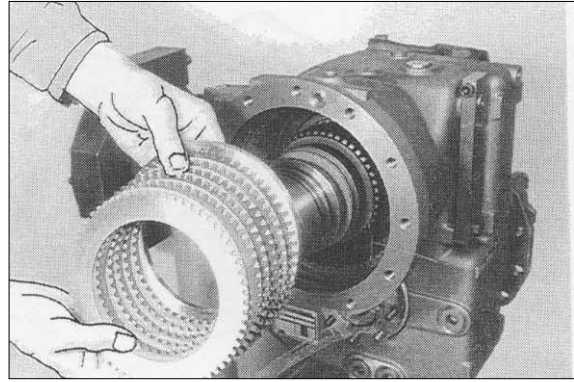

20W78TM13

(14) Squeeze out circlip(Arrow).

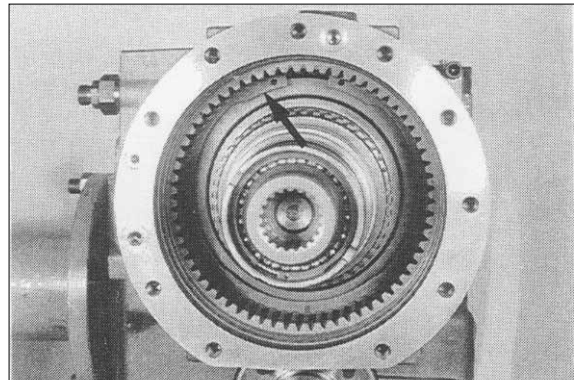

20W78TM14

(15) Remove clutch unit.

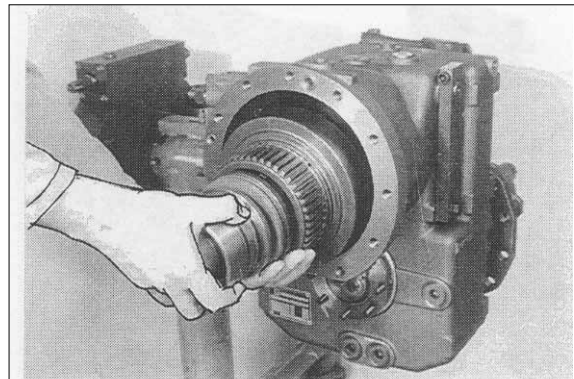

20W78TM15

(16) Fix sun gear axially by means of assembly jig, squeeze out circlip and relax the cup spring pack.

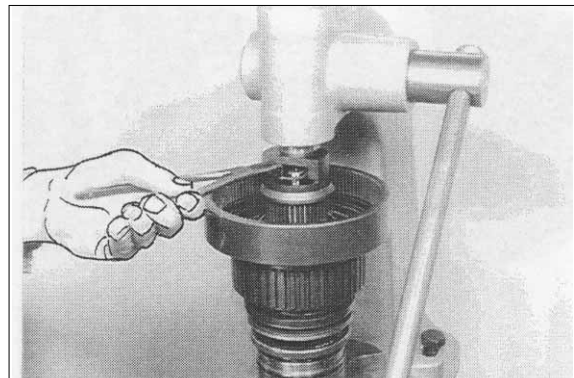

20W78TM16

(17) Remove released disk and sun gear.

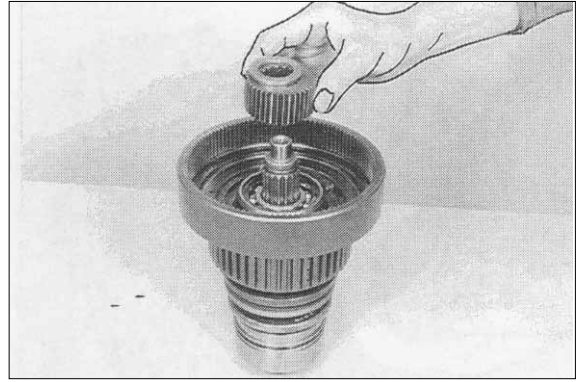

(18) Separate internal gear from drive shaft.

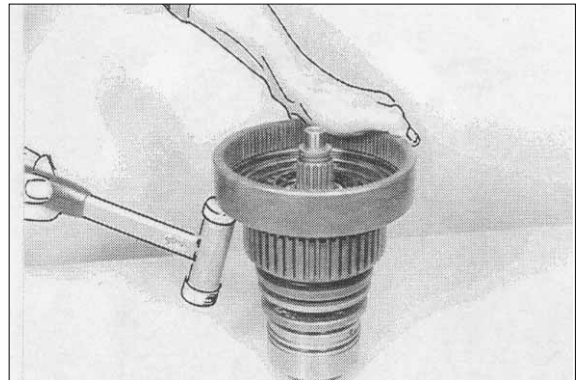

(19) Squeeze out circlip and remove centering disk.



(20) Remove plate pack.

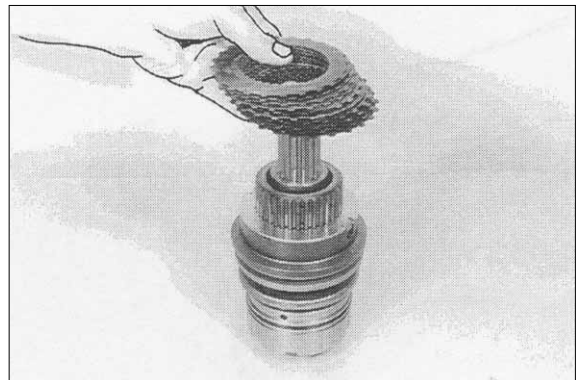

(21) Remove plate.

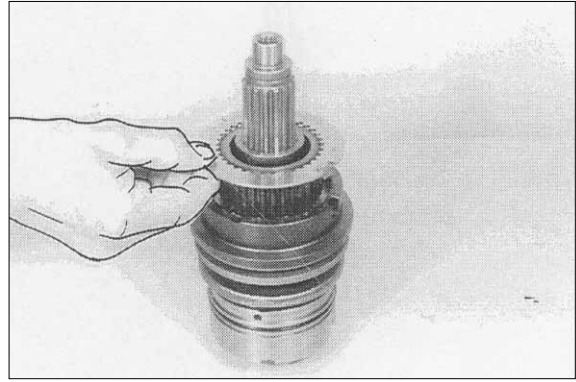

20W78TM21

(22) Pry inner plate carrier out of the piston.

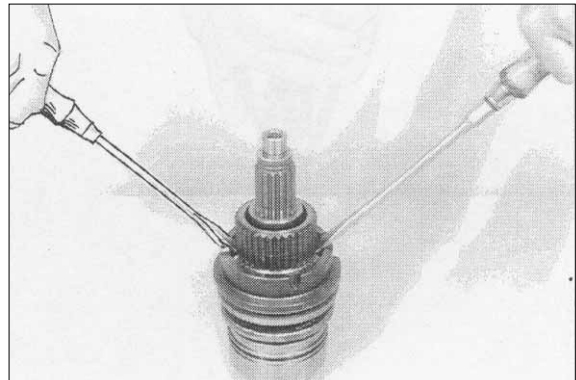

20W78TM22

(23) Pry off piston from the drive shaft.

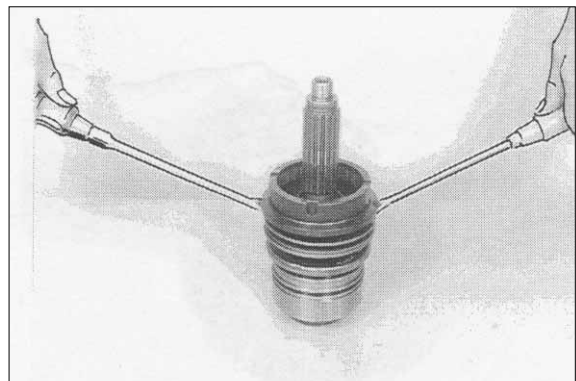

20W78TM23

(24) Remove cup spring pack.

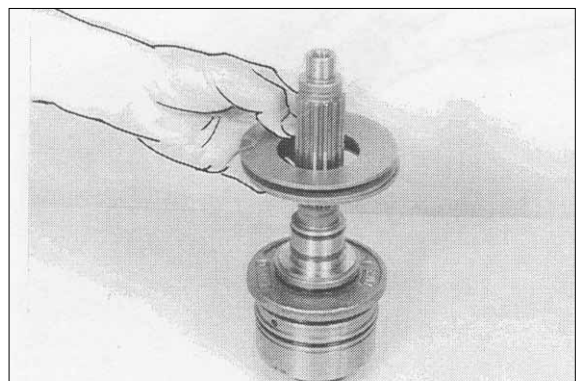

20W78TM24

- (25) Remove seal ring and O-ring.
Remove disk(Arrow).
i Renew sealing components at any rate.

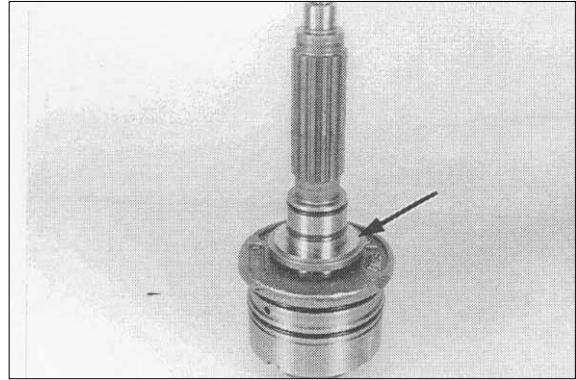

20W78TM25

- (26) Squeeze out circlip.

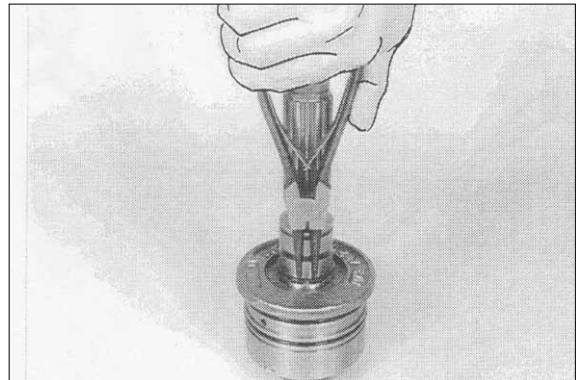

20W78TM26

- (27) Remove circlip from the ring groove of the guide bush(φ 85mm).

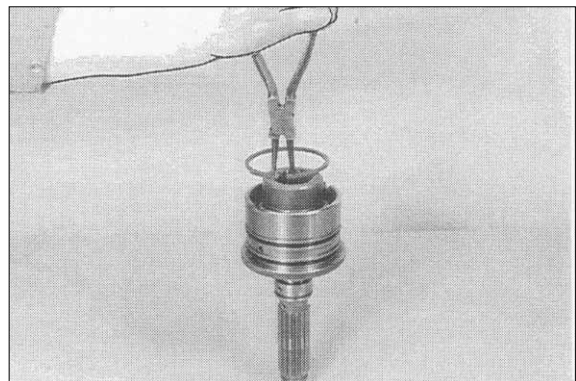

20W78TM27

- (28) Separate guide bush from drive shaft.

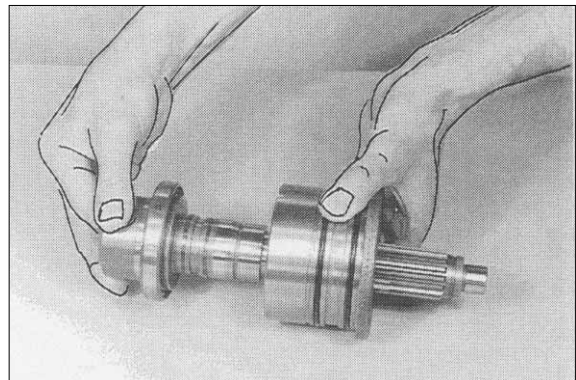

20W78TM28

(29) Squeeze out snap ring and remove shaft seal (Arrow).

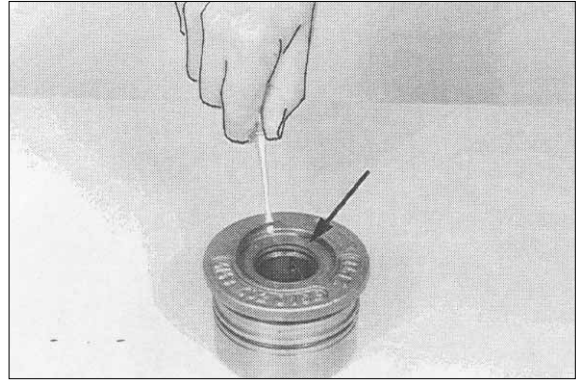

20W78TM29

(30) Squeeze out circlip and press bearing from shaft.

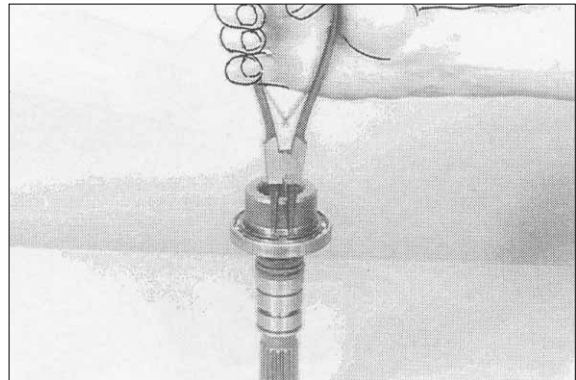

20W78TM30

(31) Remove throttle valve.

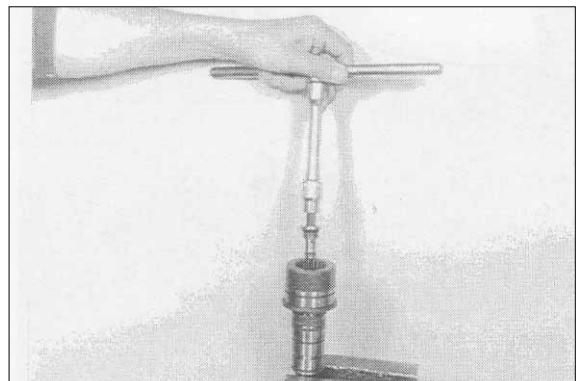

20W78TM31

2) REMOVE AND DISASSEMBLE PLANETARY DRIVE

(1) Squeeze out circlip(Arrow).

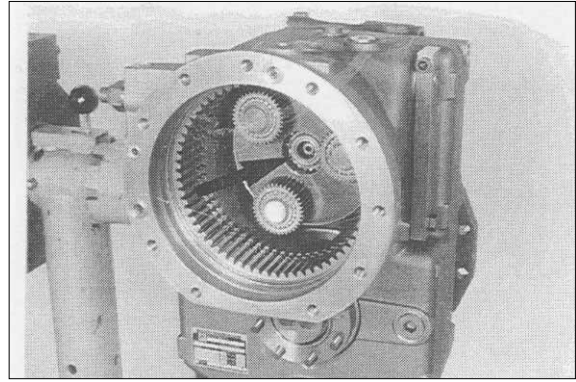

20W78TM32

(2) Tilt housing for 90 degrees.
Separate and remove planetary carrier from helical gear, using internal puller.

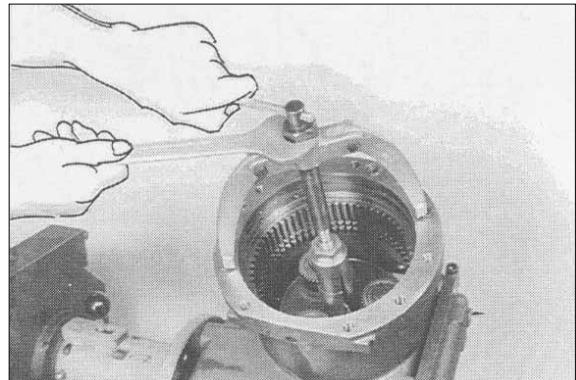

20W78TM33

(3) Squeeze out circlip.

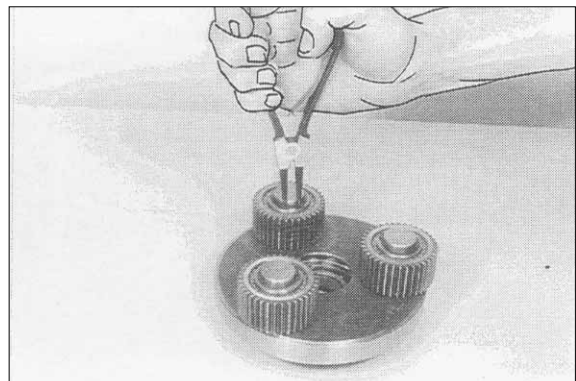

20W78TM34

(4) Pry off planetary gear from planetary shaft, using offset screw driver.
Remove released components.

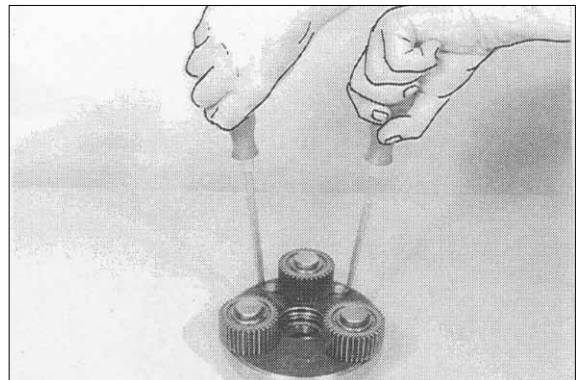

20W78TM35

(5) Pull off bearing inner race.

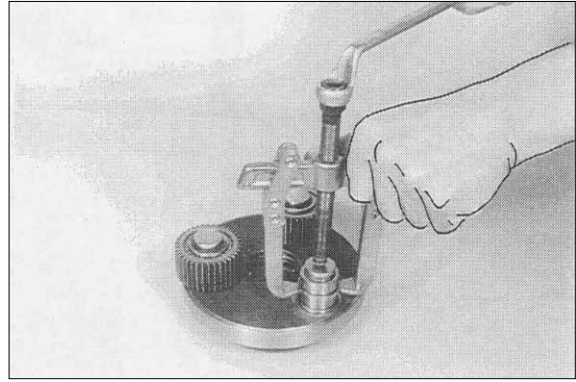

20W78TM36

(6) Squeeze out circlip and remove ball bearing.

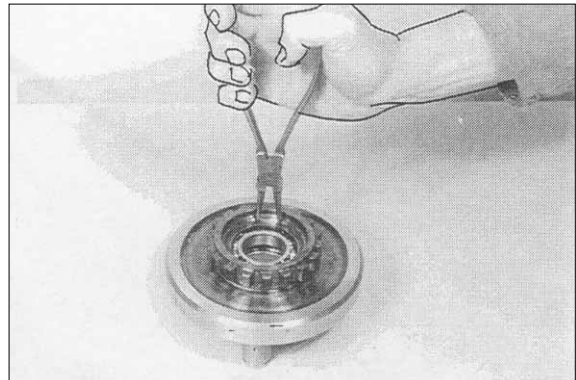

20W78TM37

3) REMOVE AND DISASSEMBLE DECLUTCH UNIT AND SPUR GEAR

(1) Loosen hex head screw(shift lever locking) and remove sliding collar along with sliding blocks.

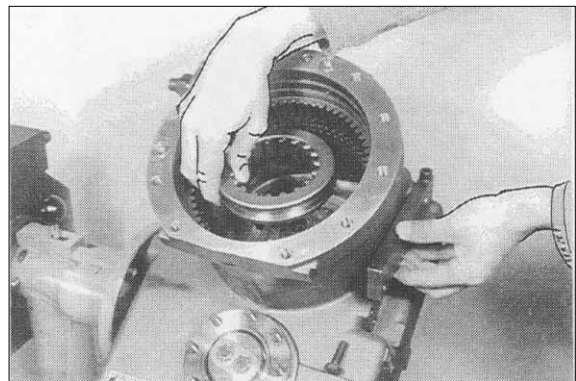

20W78TM38

(2) Loosen screw plug.

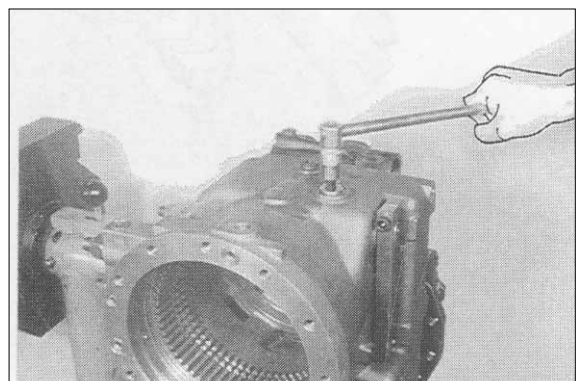

20W78TM39

(3) Drive out roll pin(Arrow).

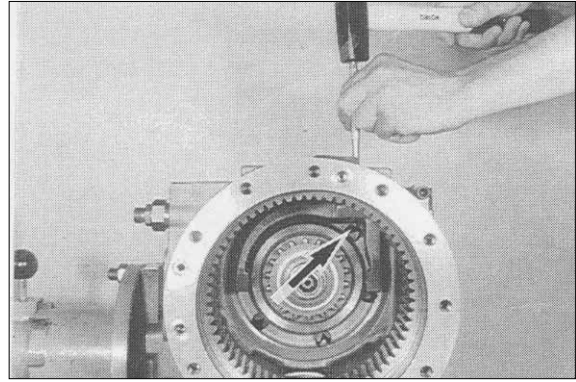

20W78TM40

(4) Pry shift lever out of the housing bore and remove released shift fork.

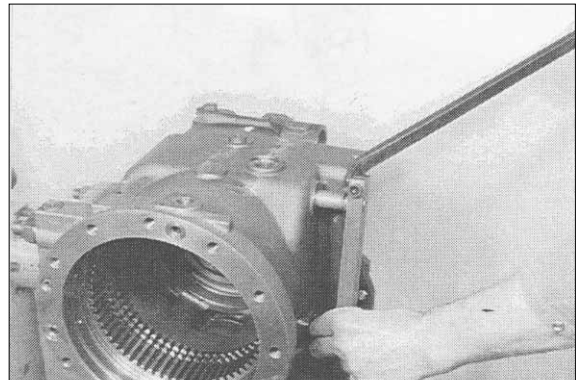

20W78TM41

(5) Remove suction line.

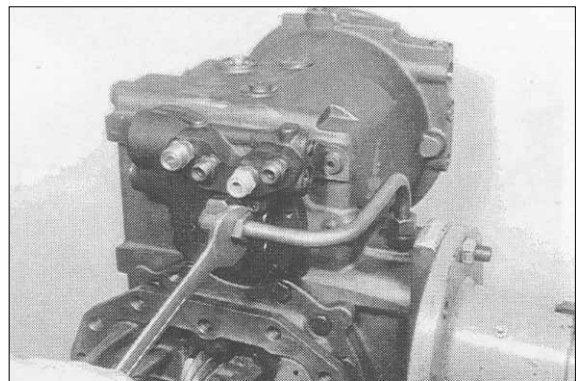

20W78TM42

(6) Loosen socket head screws and separate shift lock from housing.

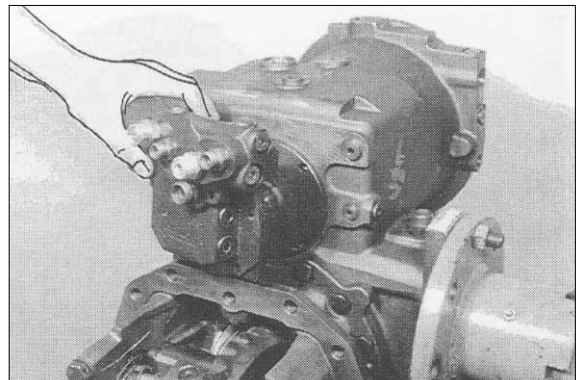

20W78TM201

(7) Squeeze out circlip.

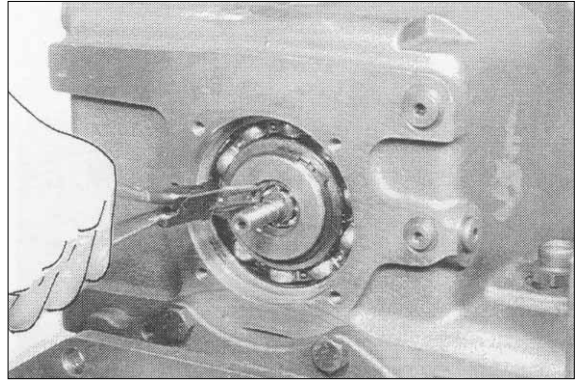

20W78TM202

(8) Remove pump shaft.

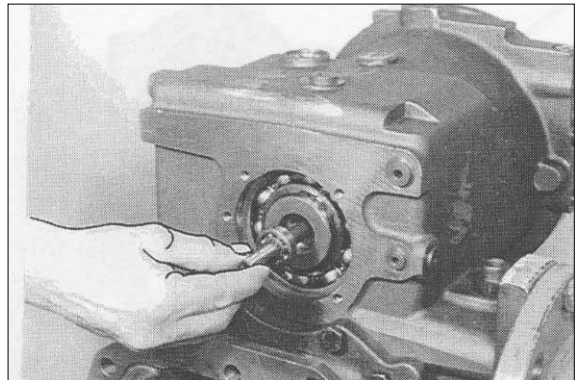

20W78TM203

(9) Squeeze out circlip.

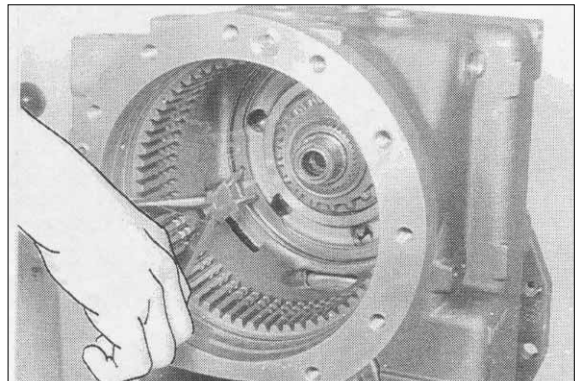

20W78TM43

(10) Pry off helical gear and take it out of the housing.



20W78TM44

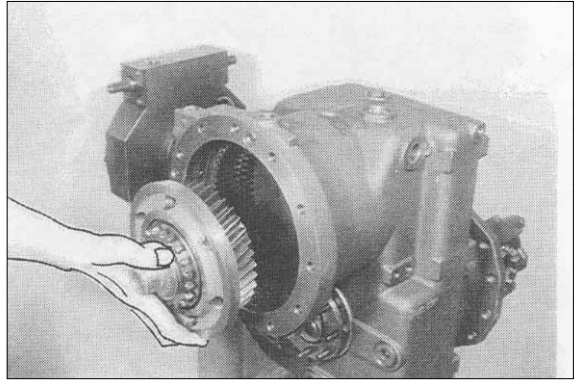

20W78TM45

(11) Squeeze out circlip and remove shim.

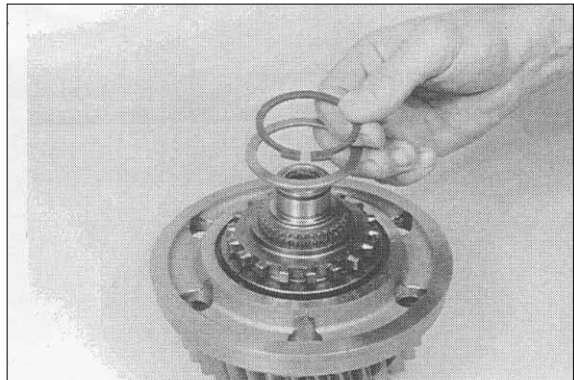

20W78TM46

(12) Remove shift dog and spacer.

- i According to the design, with or without spacer, see Parts manual.

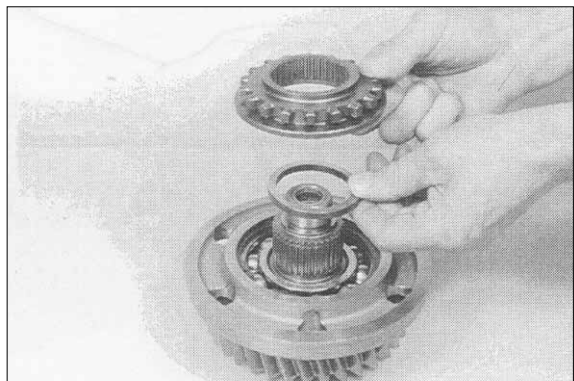

20W78TM47

(13) Pull needle bearing out of the housing bore, using internal puller.

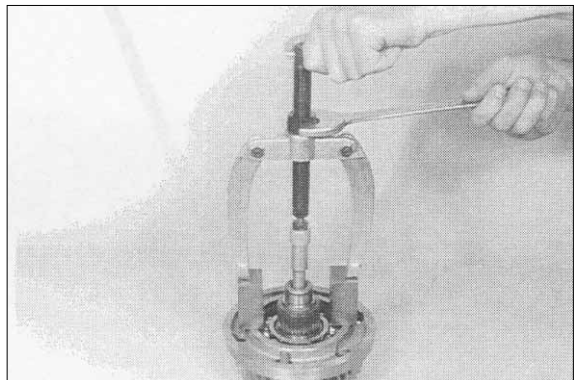

20W78TM48

(14) Press helical gear from bearing cap.

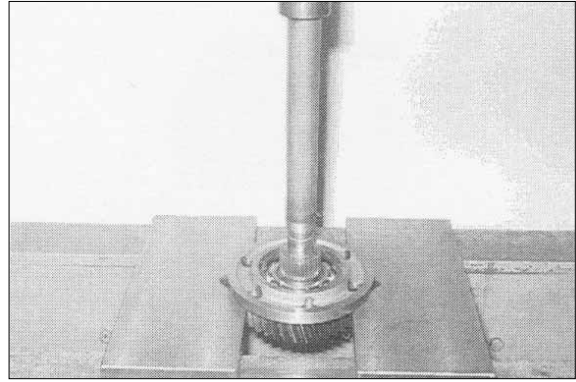

20W78TM49

(15) Squeeze out circlip and press ball bearing out of the bearing cap.

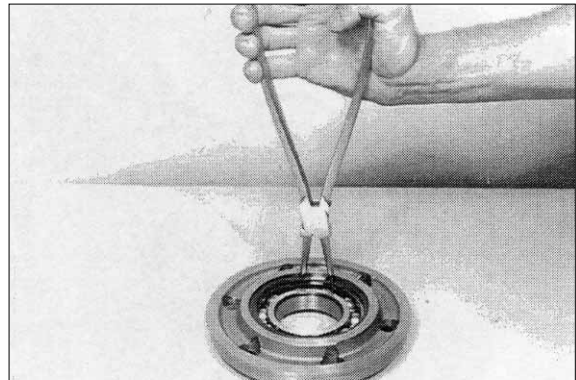

20W78TM50

(16) Squeeze out circlip.

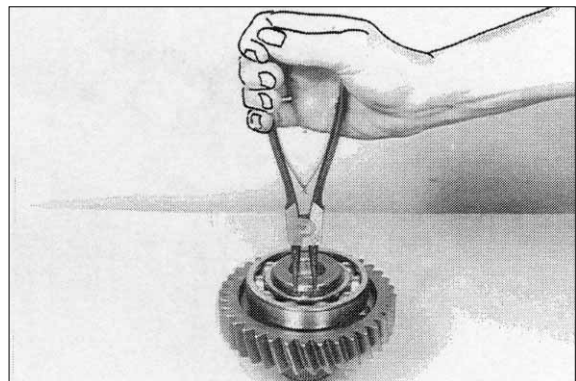

20W78TM51

(17) Pry off ball bearing from helical gear collar.

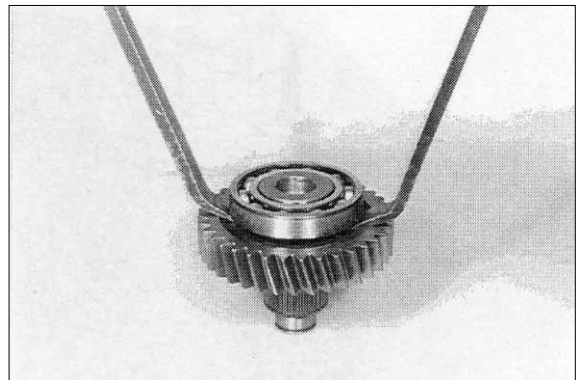

20W78TM52

4) DISASSEMBLE FINAL DRIVE(Separate gearbox installation)

- (1) Unlock and loosen hex head screws and remove output flange.

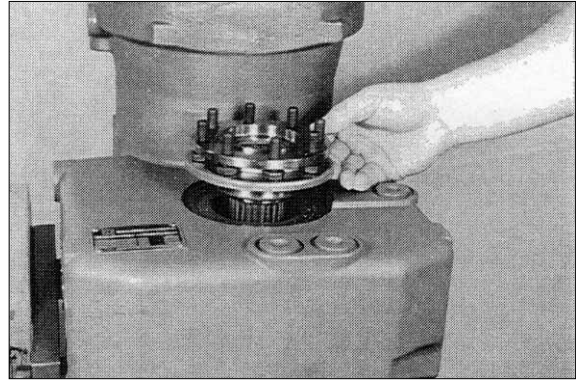

20W78TM53

- (2) Pry shaft out of the housing bore.

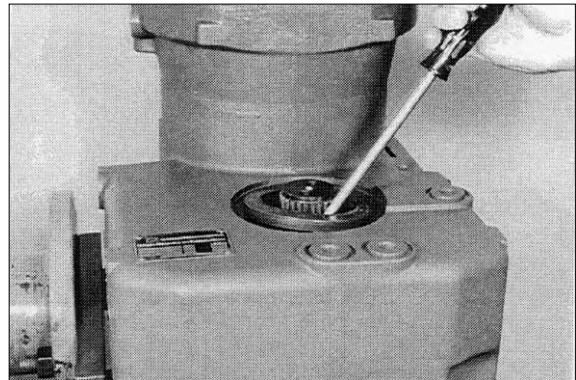

20W78TM54

- (3) Tilt housing 180 degrees
Unlock and loosen hex head screws and remove output flange.

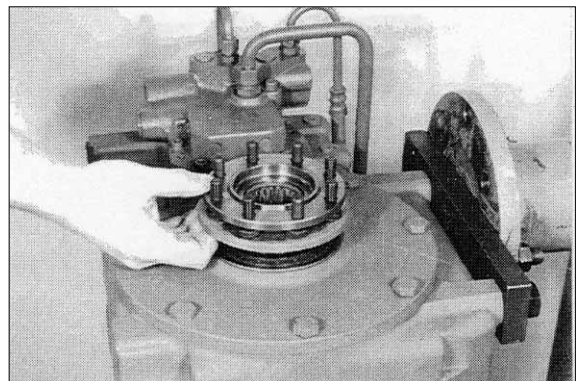

20W78TM55

- (4) Remove shaft seal.

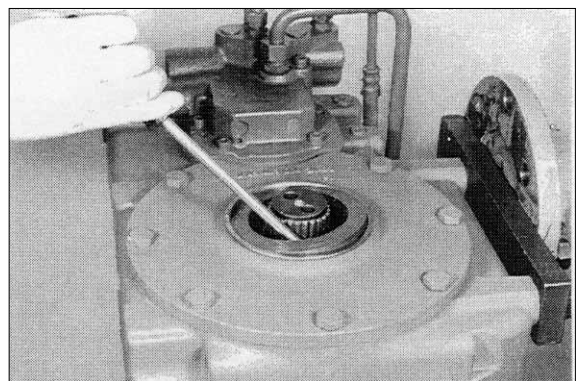

20W78TM56

(5) Loosen hex head screws.

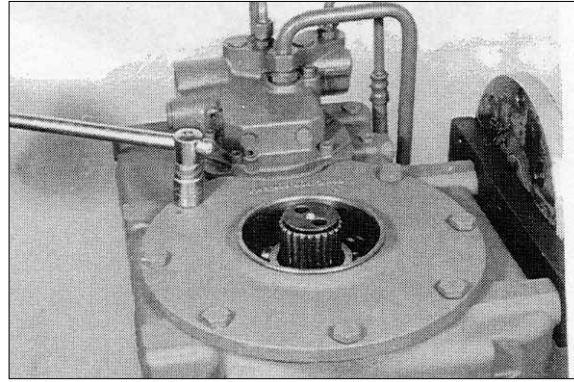

20W78TM57

(6) Separate output gear along with cover from the gear case, using hoist.

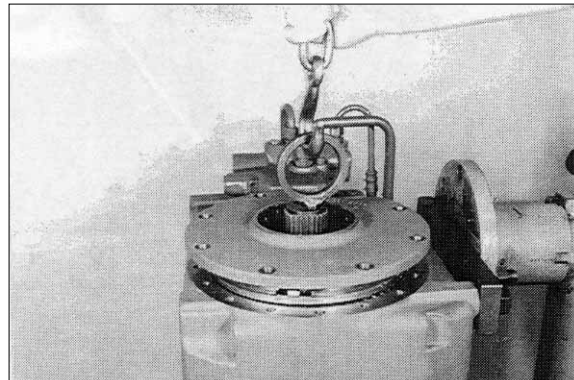

20W78TM58

(7) Press output gear out of the bearing cap, reps. out of the ball bearing.

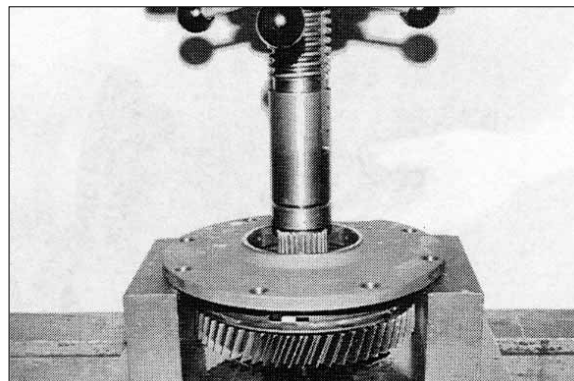

20W78TM59

(8) Remove oil baffle plate.

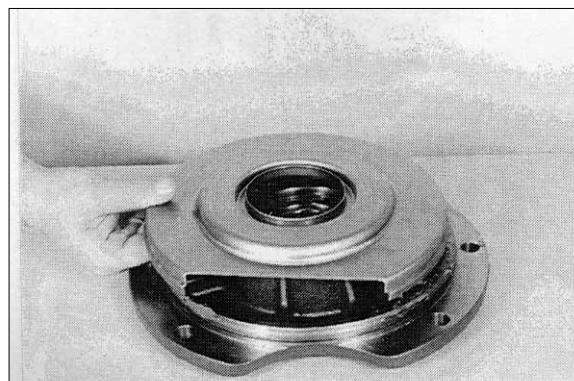

20W78TM60

(9) Squeeze out circlip.

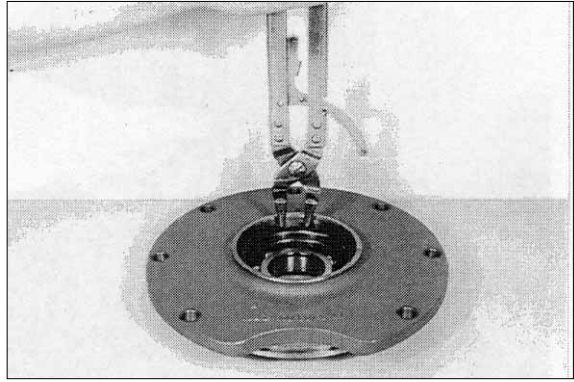

20W78TM61

(10) Press ball bearing out of the bearing bore.

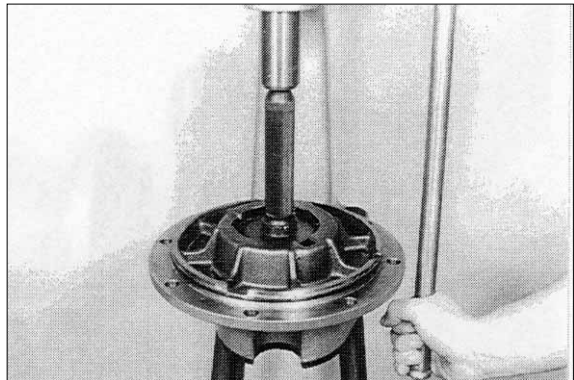

20W78TM62

(11) Remove oil baffle plate.

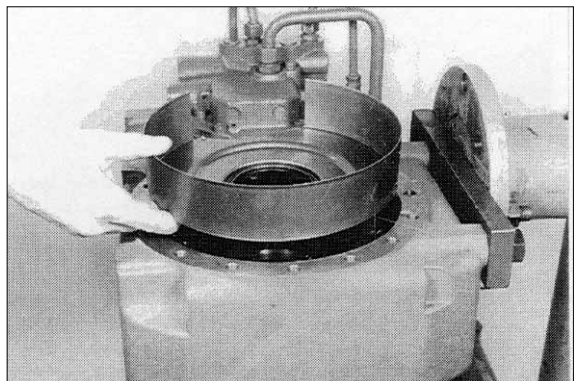

20W78TM63

(12) Drive ball bearing out of the bearing bore.

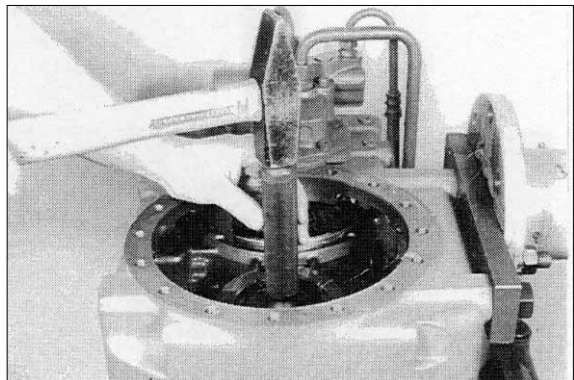

20W78TM64

5) DISASSEMBLE ALUMINUM DIE-CAST GEAR BOX CONTROL

- (1) Separate oil pipe as well as hose lines from the cover.

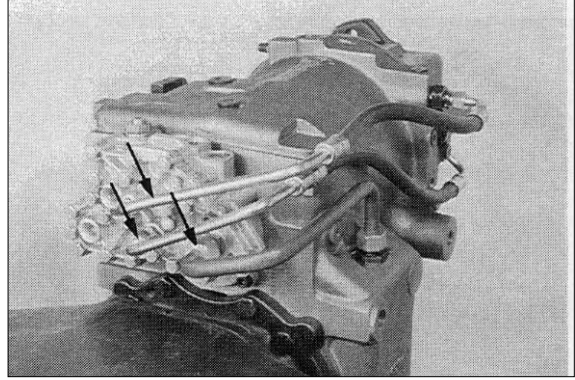

20W78TM65

- (2) Loosen socket head screws(4EA, see Arrows) and separate shift lock from transmission case.

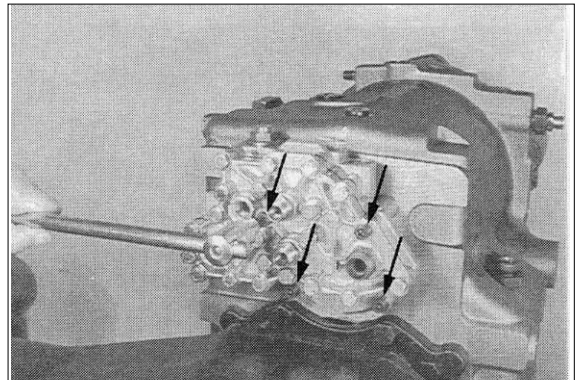

20W78TM66

- (3) Loosen all hex head screws and separate cover as well as gasket from the case.

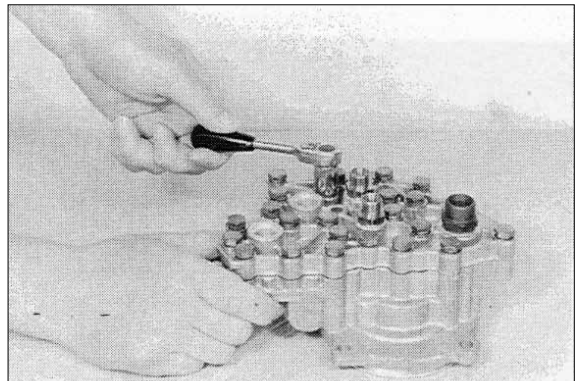

20W78TM67

- (4) Loosen hex head screws and separate pump cover from the case.

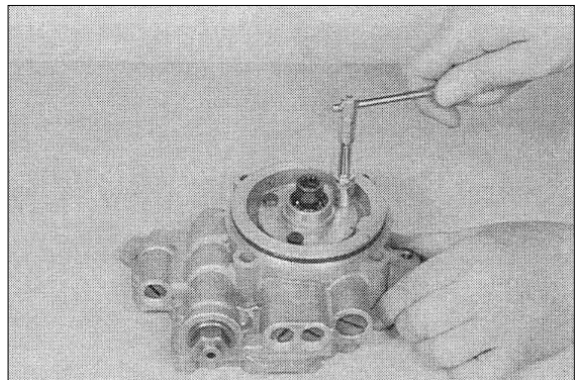

20W78TM68

- (5) Pull internal rotor(Arrow) from the pump shaft.

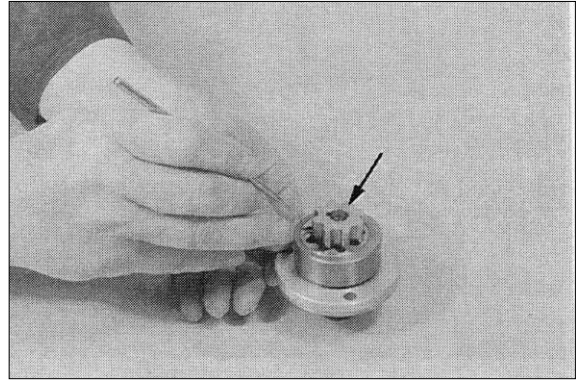

20W78TM69

- (6) Remove the ball(position see Arrow) and pull the control case along with the external rotor from the pump shaft.
i Pay attention to the released balls and compression springs.

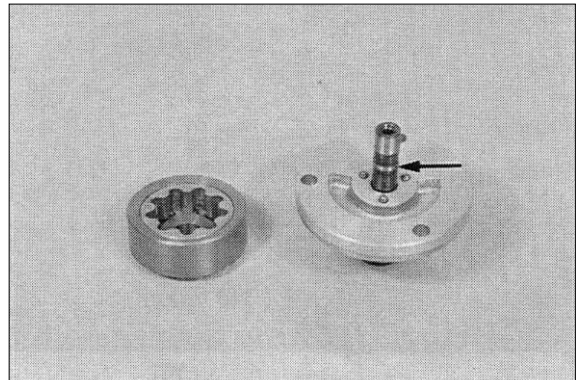

20W78TM70

- (7) Remove the pump shaft.

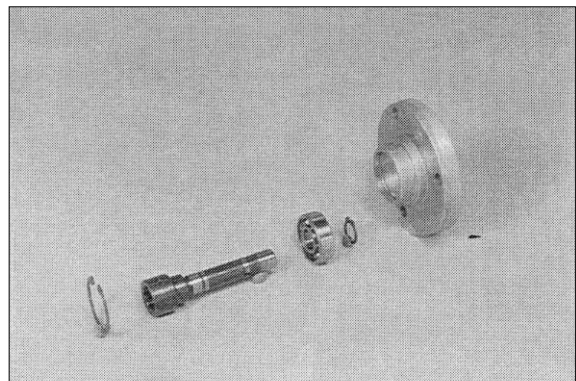

20W78TM71

- (8) Pull needle cage out of the case bore.

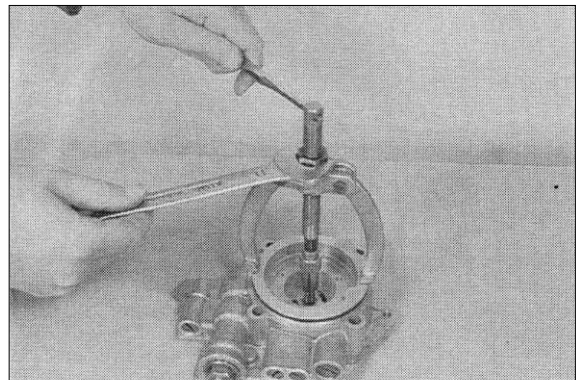

20W78TM72

- (9) Remove check valves and spool.
i Mark the installation position of the single check valves.

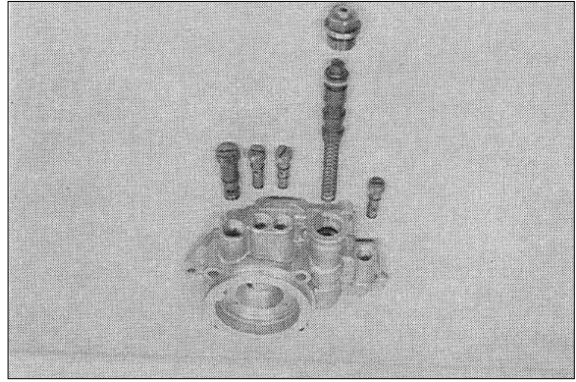

20W78TM73

4. ASSEMBLY

1) REASSEMBLE ALUMINUM DIE-CAST GEAR BOX CONTROL

- (1) Wet contact surface of the orifice with loctite and insert orifice until contact is obtained.
Now, clean the orifice by means of compressed air from loctite residues.

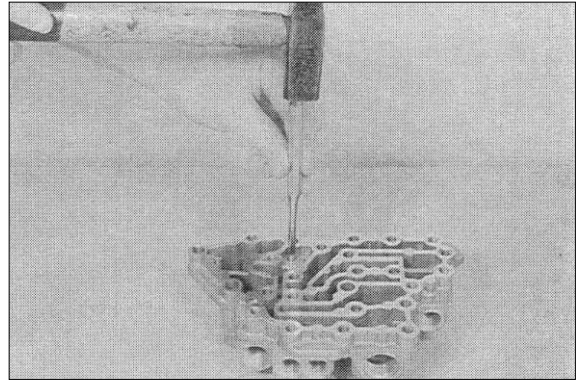

20W78TM74

- (2) Install needle cage.
 - i By application of the prescribed drift, the required installation depth of $0.2 + 0.5\text{mm}$ is obtained.
install the needle cage with the reinforced shell facing the pressing tool.

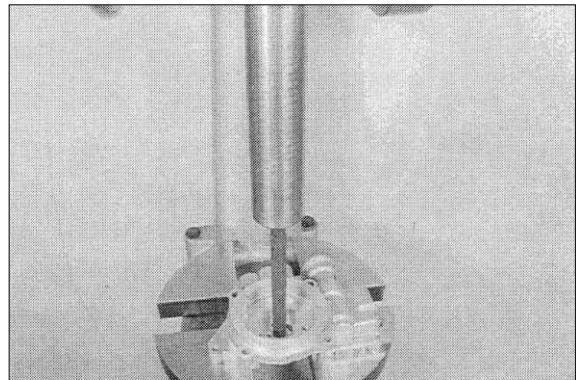

20W78TM75

- (3) Install gasket (composed of plastic ring and O-ring).
Insert O-ring (Arrow) into the annular groove of the spool.
Guide the plastic ring by means of installer (S) over the spool and position it on the O-ring.

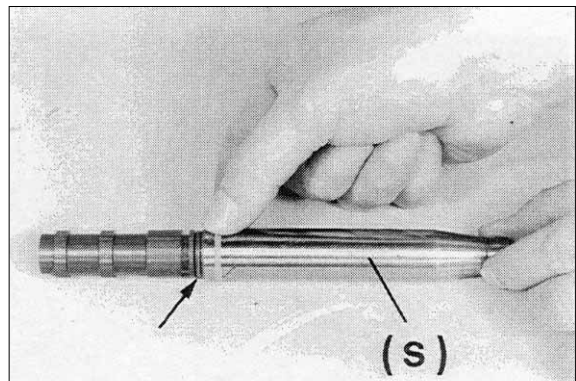

20W78TM76

- (4) Calibrate plastic ring by means of bush (S).

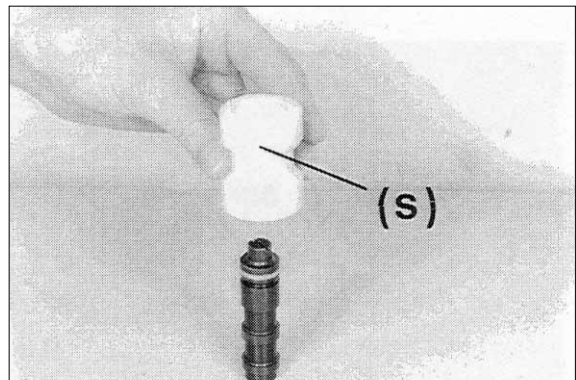

20W78TM77

(5) Install components according to the illustration.

- i Pay attention to the installation position of the different check valves.

Oil components.

1	Check valve	1.0kg _i /m
2	Compression spring	
3	Spool	
4	Screw plug	5.1kg _i /m
5	Seal ring	
6	Screw plug	2.0kg _i /m
7	Check valve	1.0kg _i /m
8	Check valve	1.0kg _i /m
9	Pressure limiting valve	1.0kg _i /m

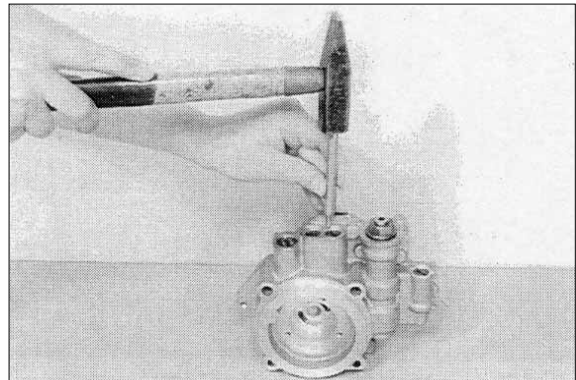
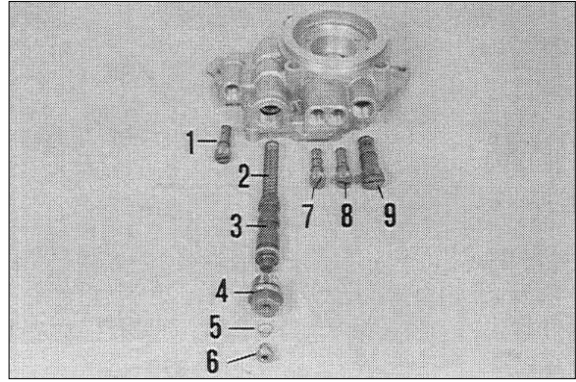

- i Equip all check valves as well as pressure limiting valves with new O-rings.

Secure check valves and pressure limiting valves (items 1, 7, 8 and 9) by centerpunching each of them twice.

Pre-assemble pump cover according to the illustration.

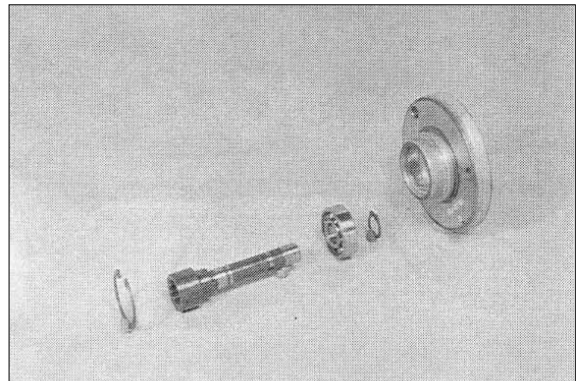

(6) Insert compression spring(1) and balls(2) with grease into the bores (Arrows) of the pump cover.

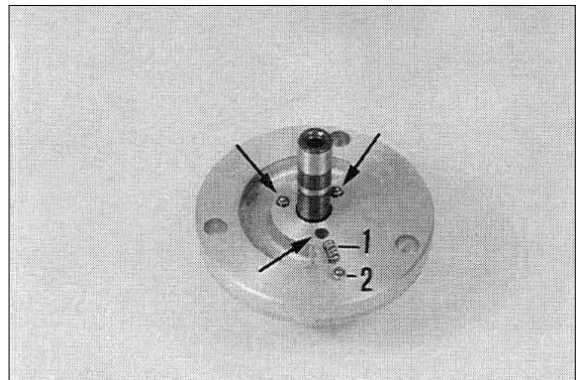

(7) Oil pump.

- i The rotor set(Composed of control case, external and internal rotor) may be exchanged only completely.
Assemble control case along with the external rotor.

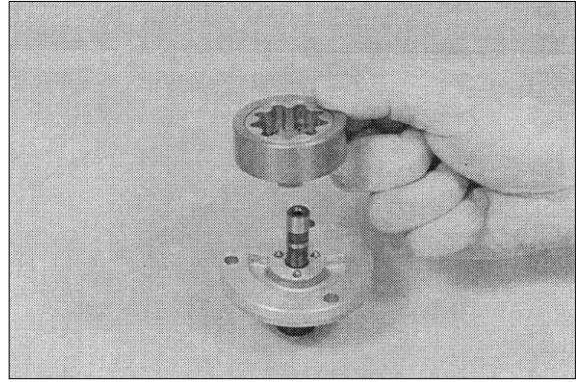

20W78TM82

(8) Insert ball with grease into the countersinking of the pump shaft(Arrow) and assemble the internal rotor.

- i The drive of the internal rotor is realized by the ball.
Pay attention to the exact installation position.

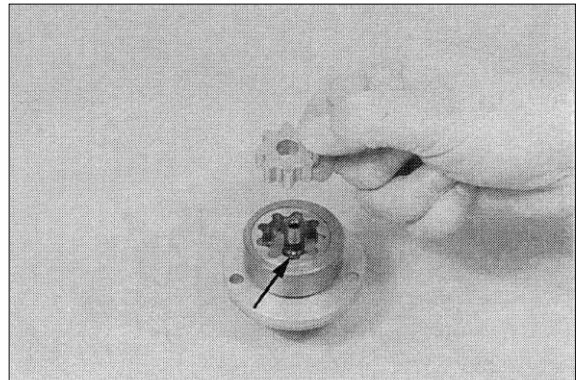

20W78TM83

(9) Insert pre-assembled pump cover into the case bore and fasten it by means of hex head screws(M6).

- i Oil the rotor set.
 - i Tightening torque : 0.97kgf_i·m(7.0lb_i/ft)

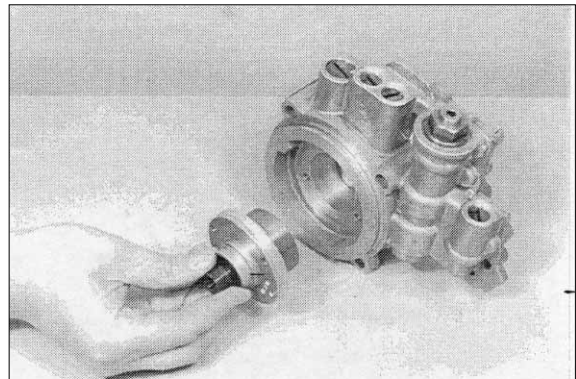

20W78TM84

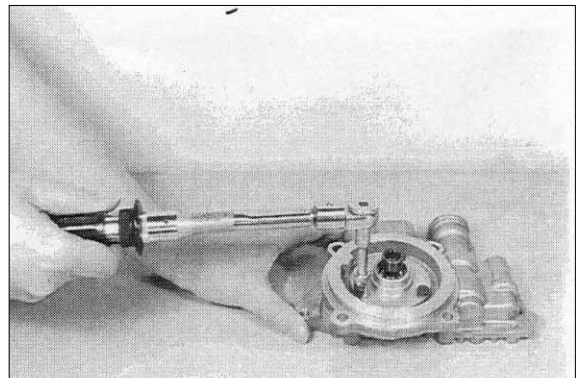

20W78TM85

- (10) Insert O-ring into the annular groove (Arrow) and grease it.

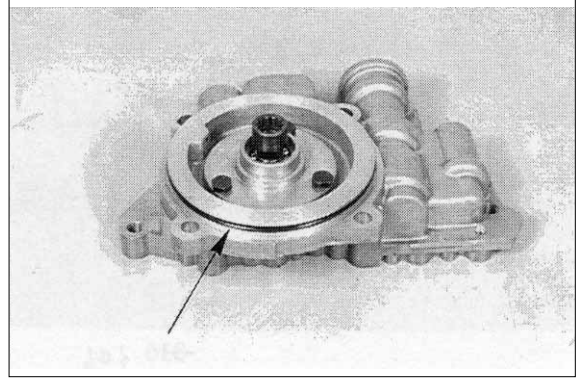

20W78TM86

- (11) Install both adapters as well as the threaded socket.

- ; Install new O-rings.
- ; Tightening torque(Adapter) : 2.5kgf ; m (18lb ; ft)
- ; Tightening torque(Threaded socket) : 3.6kgf ; m(26.0lb ; ft)

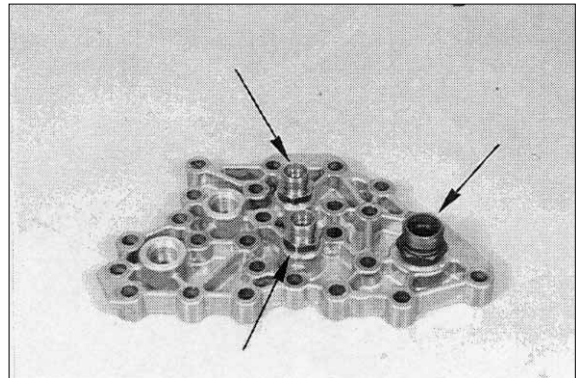

20W78TM87

- (12) Install two adjusting screws(M8).
Assemble gasket and cover.



20W78TM88

- (13) Fasten cover by means of hex head screws(Mount flat washers).

- ; Tightening torque : 2.0kgf ; m(14.7lb ; ft)

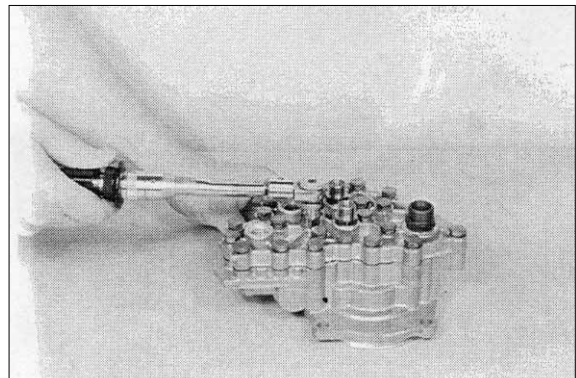

20W78TM89

(14) Introduce pump shaft until the splines are engaged.

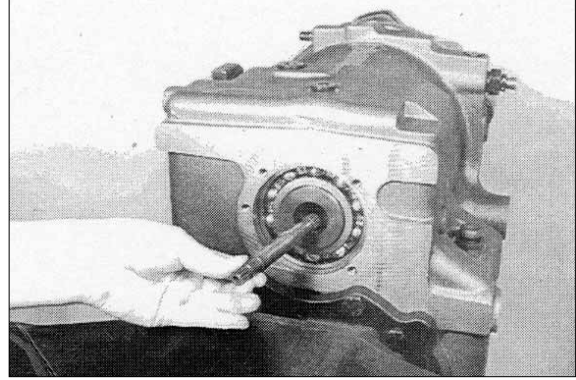

20W78TM90

(15) Install two adjusting screws and place the shift lock against the transmission case until contact is obtained.
Adjusting screw(M8).



20W78TM91

(16) Fasten the shift lock on the transmission case, using socket head screws(mount flat washers).
; Tighten torque : 2.3kgf ; m(17.0lb ; ft)

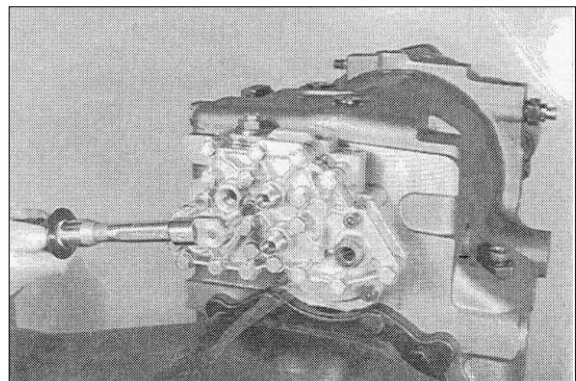

20W78TM92

(17) Install oil pipe as well as hose lines (Arrows) according to the figure.
; Before the unit is put into service, pay attention to the instructions for operation and maintenance.

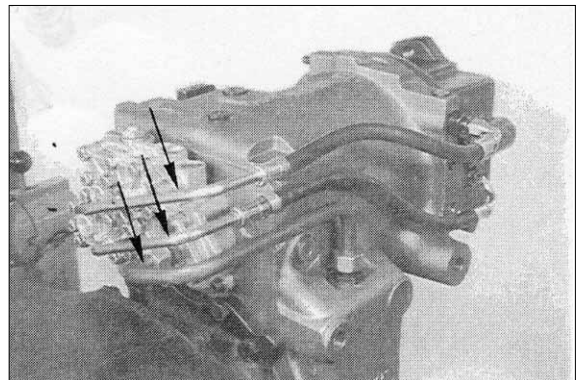

20W78TM93

2) REASSEMBLE FINAL DRIVE

- (1) Undercool ball bearing and insert it firmly against shoulder.



20W78TM94

- (2) Insert baffle plate firmly against shoulder.
; Pay attention to the radial installation position.

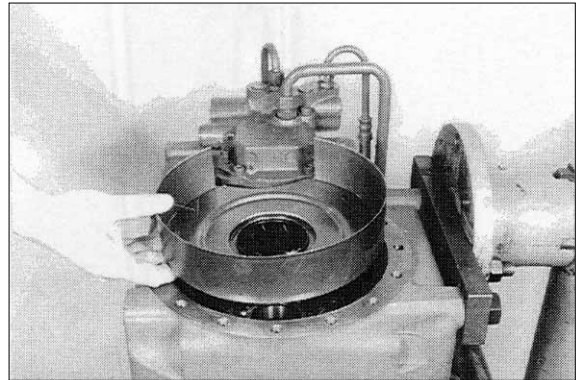

20W78TM95

- (3) Undercool ball bearing and insert it in the bore of the bearing cap until contact is obtained.

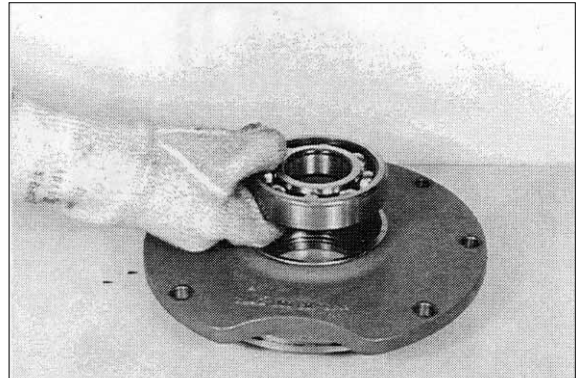

20W78TM96

- (4) Fix ball bearing by means of circlip.

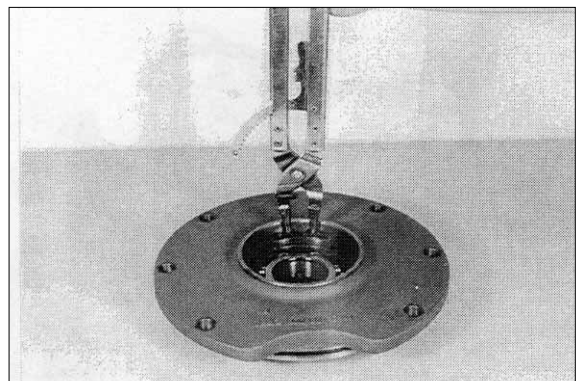

20W78TM97

- (5) Install oil baffle plate.
- i Pay attention to the radial installation position.

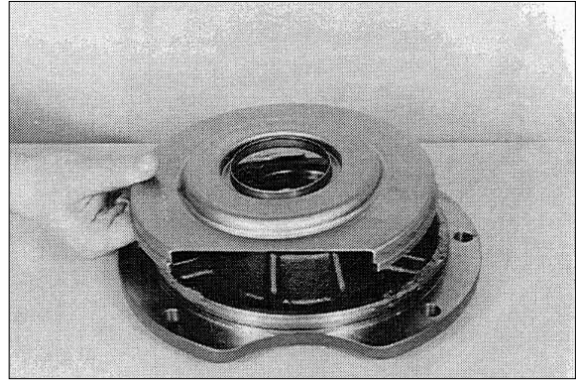

20W78TM98

- (6) Press bearing cap upon the short side of the output gear.
- i To avoid a damage to the ball bearing, apply pressing sleeve(Arrow) on the bearing inner race.

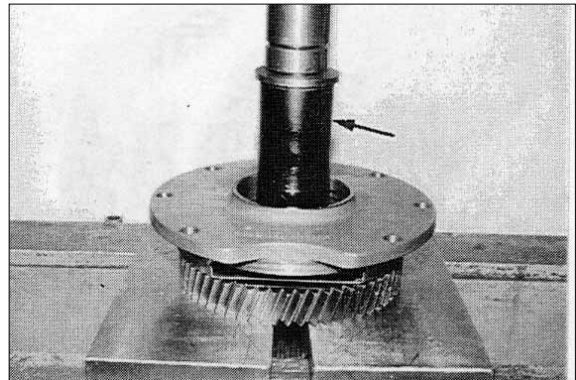

20W78TM99

- (7) Insert O-ring(Arrow) in the ring groove and grease it.

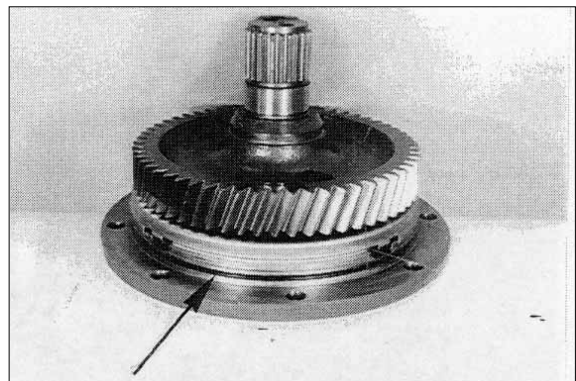

20W78TM100

- (8) Heat ball bearing, install two adjusting screws and assemble bearing cap until contact is obtained.

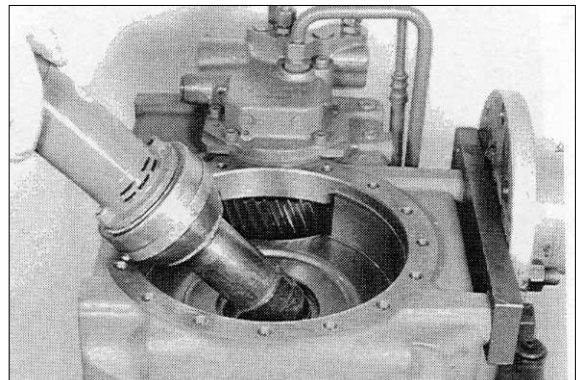

20W78TM101

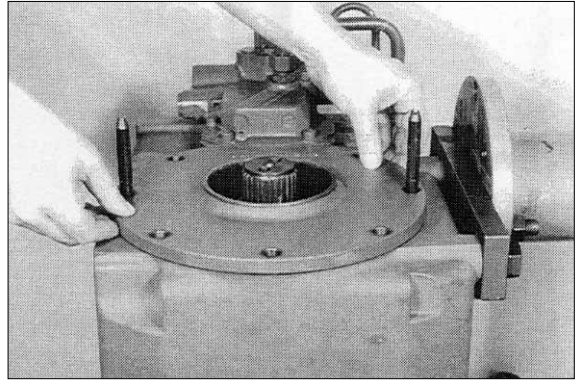

20W78TM102

- (9) Fasten bearing cap by means of hex head screws(M12).
; Tightening torque : 8.0kgf ; m(58.3lb ; ft)

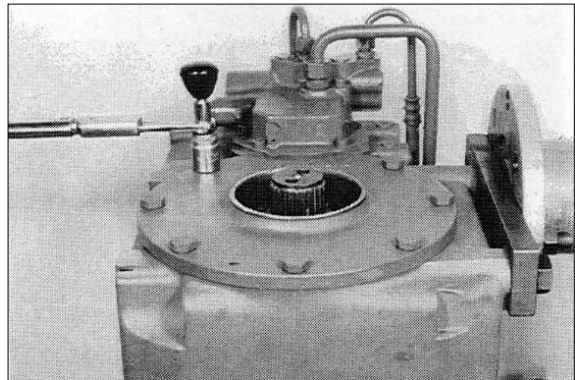

20W78TM103

- (10) Install shaft seal.
; By application of the prescribed driver, the exact installation position is obtained.
If the outer diameter is rubber-coated, wet the sealing surface with spirit.
Otherwise, use sealing compound(Curil T).
Fill cavity between sealing lip and dust lip with grease.

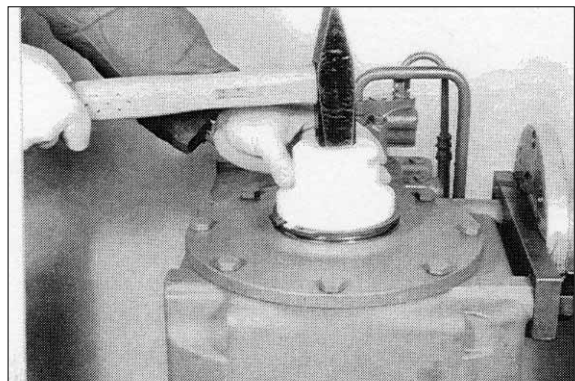

20W78TM104

- (11) Insert hex head screws in the bores of the output flange and press dust plate (Arrow) against shoulder.
Pre-assemble the opposite output flange accordingly.

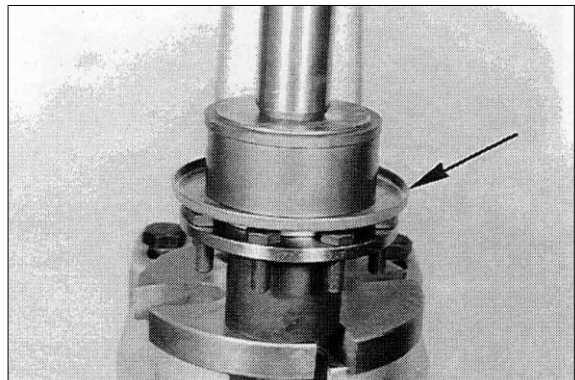

20W78TM105

- (12) Assemble output flange.
Grease O-ring and insert it in the gap of output flange/output gear.

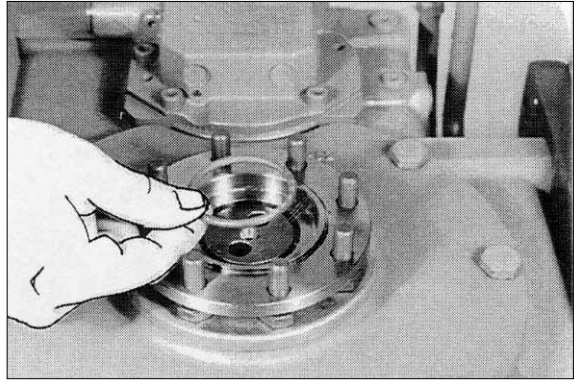

20W78TM106

- (13) Mount washer and fix output flange by means of hex head screws(M10).
Tightening torque : 4.7kgf/m(33.9lb/ft)

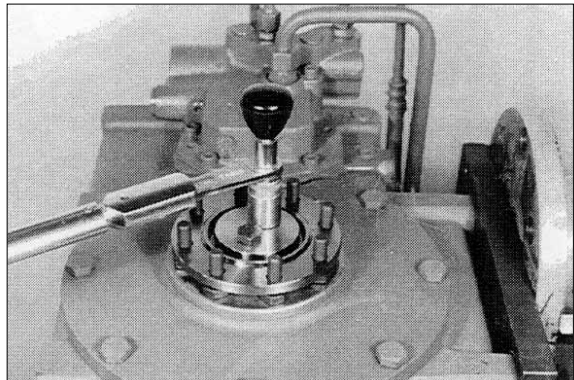

20W78TM107

- (14) Fix hex head screws by means of lock plate.

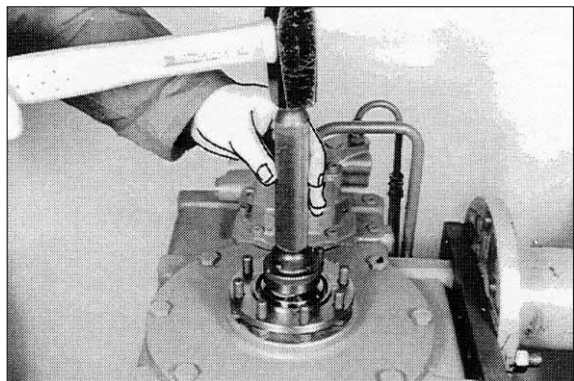

20W78TM108

- (15) Tilt gear case 180°
Install shaft seal.
By application of the prescribed driver, the exact installation position is obtained.
If the outer diameter is rubber-coated, wet the sealing surface with spirit.
Otherwise, use sealing compound(Curl T).
Fill cavity between sealing lip and dust lip with grease.

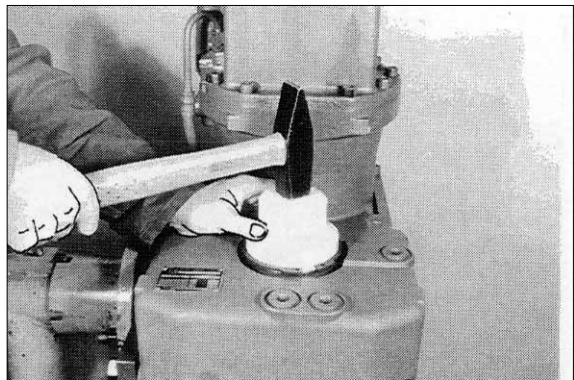

20W78TM109

- (16) Assemble output flange.
Grease O-ring and insert it in the gap of output flange/output gear.

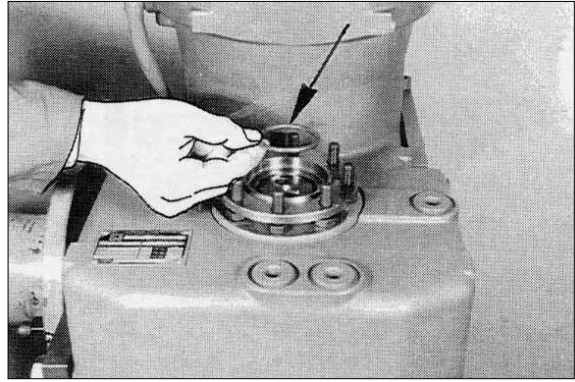

20W78TM110

- (17) Mount washer and fasten output flange by means of hex head screws.
Now, fix hex head screws(M10) by means of lock plate(Arrow).
; Tightening torque : 4.7kgf ; m(33.9lb ; ft)

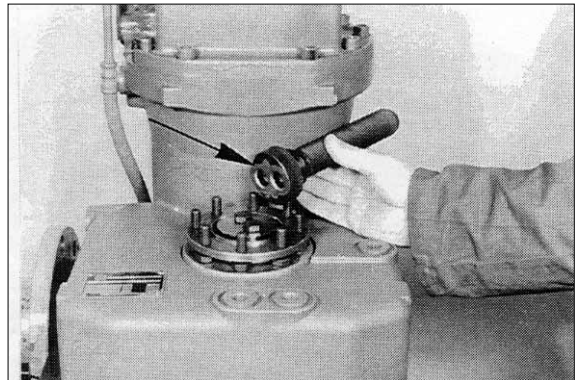

20W78TM111

3) REASSEMBLE HELICAL GEAR AND DECLUTCH UNIT

- (1) Insert ball bearing into the bearing cover until contact is obtained and fix with circlip.

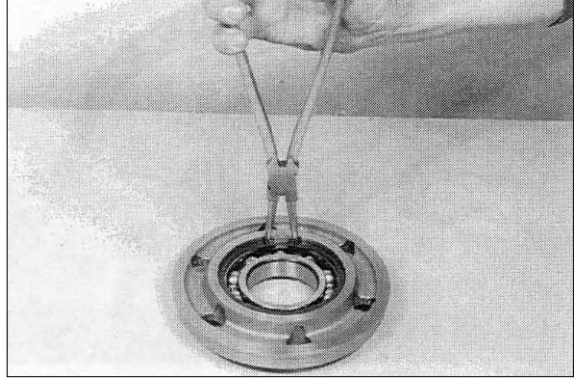

20W78TM112

- (2) Press ball bearing over the collar of the helical gear until contact is obtained and fix by means of circlip.

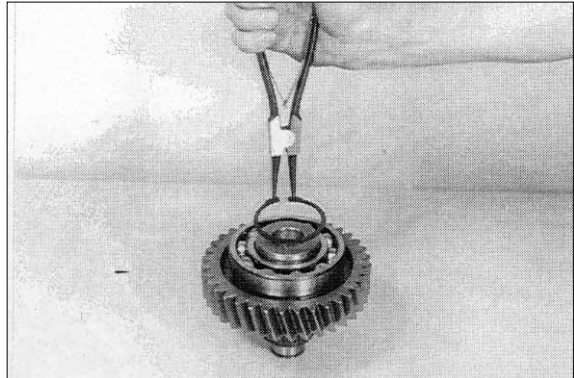

20W78TM113

- (3) Press bearing cover(Ball bearing) firmly against shoulder with the circlip showing toward above.

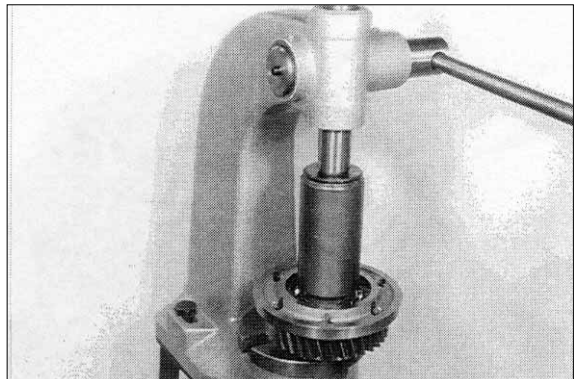

20W78TM114

- (4) Install spacer and shift dog.
 - i According to the design with or without spacer, see corresponding Parts manual.

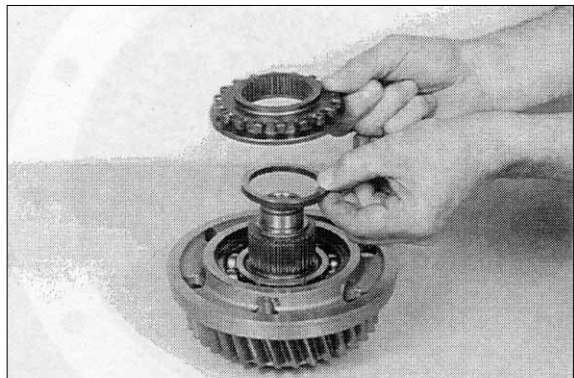

20W78TM115

- (5) Fix shift dog by means of shim and circlip.
i Pay attention to the permissible end play max. 0.1mm.

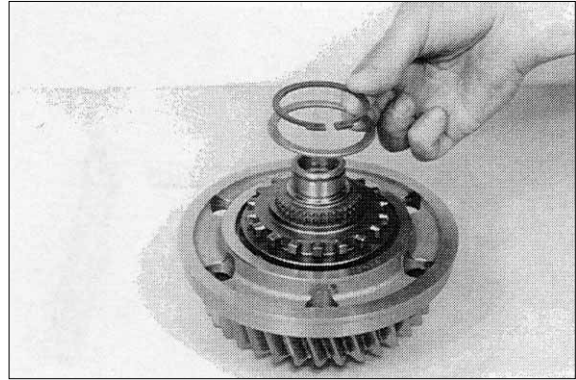

20W78TM116

- (6) Press needle bearing firmly against shoulder.
i Pay attention to the installation position-designation showing upward.

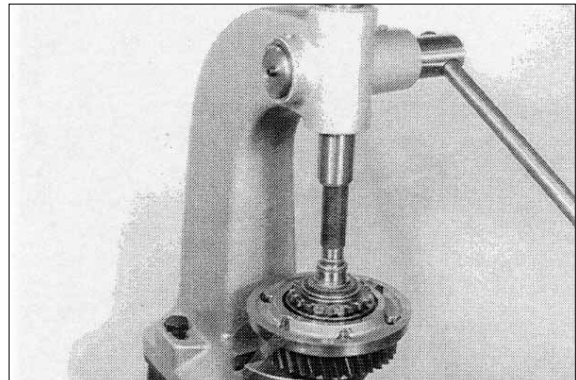

20W78TM117

- (7) Insert pre-assembled helical gear into the housing bore.

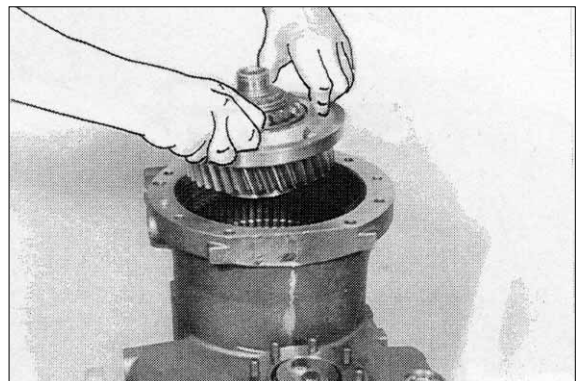

20W78TM118

- (8) Fix bearing cover by means of circlip, see Arrow.

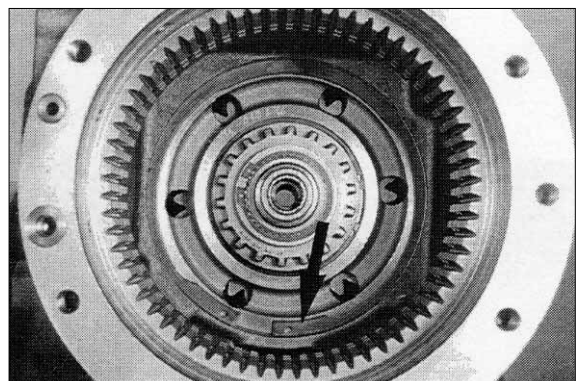

20W78TM119

(9) Figure on the left shows the components of the shift dog assembly.

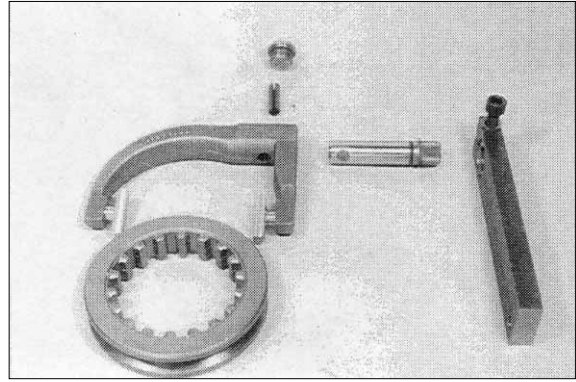

20W78TM120

(10) Squeeze in circlip(1) and install O-ring(2).

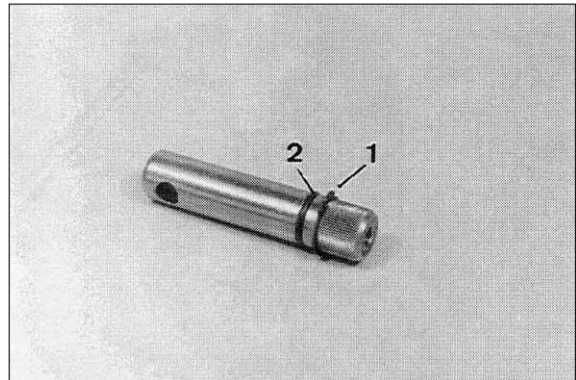

20W78TM121

(11) Insert shift fork and sliding collar.

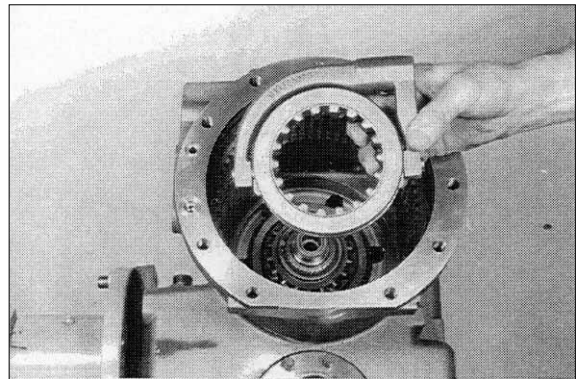

20W78TM122

(12) Introduce shift shaft until contact is obtained.

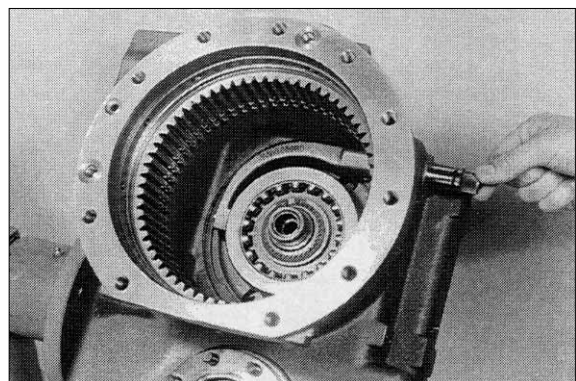

20W78TM123

- (13) Align shift shaft radially and fix it by driving the roll pin in until it is flush.

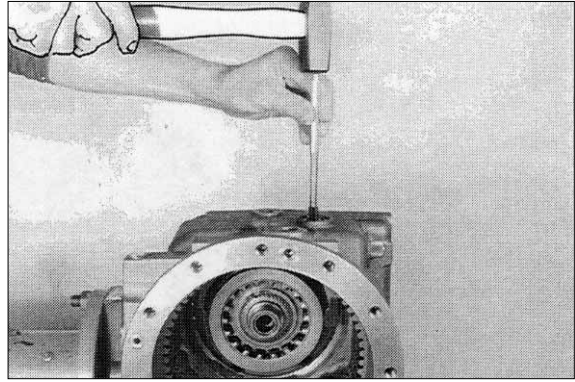

20W78TM124

- (14) Install screw plug(M22 ; ± 1.5).
; Tightening torque : 6.1kgf ; m(44.2lb ; ft)
; Mount new O-ring.

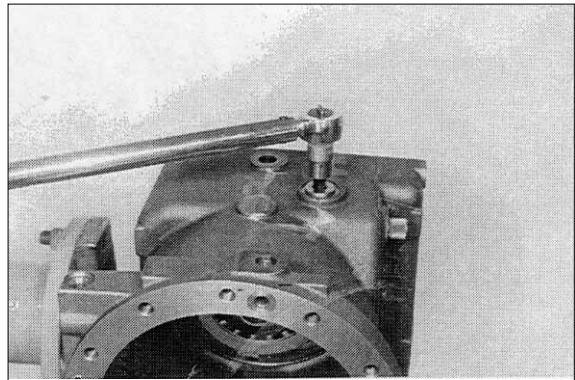

20W78TM125

4) COMPLETE AND INSTALL PLANETARY CARRIER

- (1) Pre-assemble planetary gear.
; Install cylindrical rollers with grease.

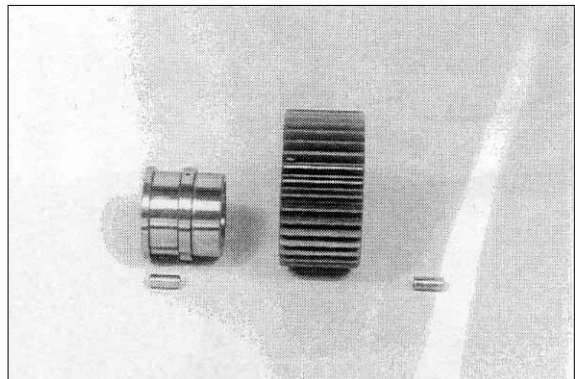

20W78TM126

- (2) Press pre-assembled planetary gears firmly against shoulder.

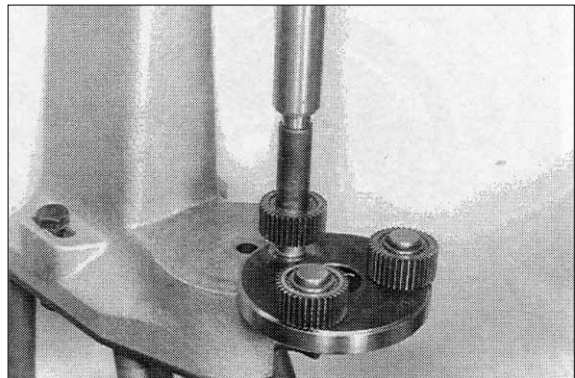

20W78TM127

(3) Install collar shim and circlip.

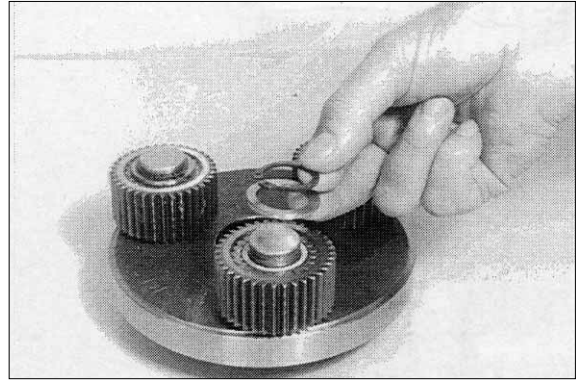

20W78TM128

(4) Insert ball bearing firmly against shoulder and fix with circlip.



20W78TM129

(5) Heat ball bearing and mount planetary carrier until contact is obtained.

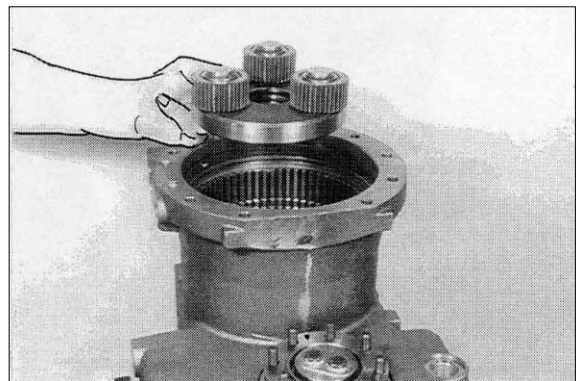

20W78TM130

(6) Fix planetary carrier with circlip(Arrow).

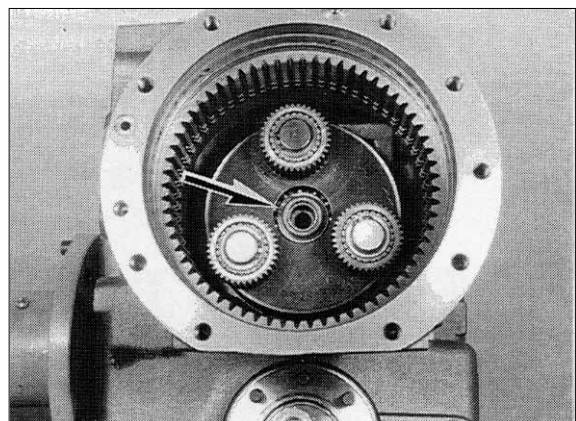

20W78TM131

Adjust declutch unit

- (7) Assemble shift lever and fix it provisionally in the "OFF-Position3" by means of hex head screw(Arrow).

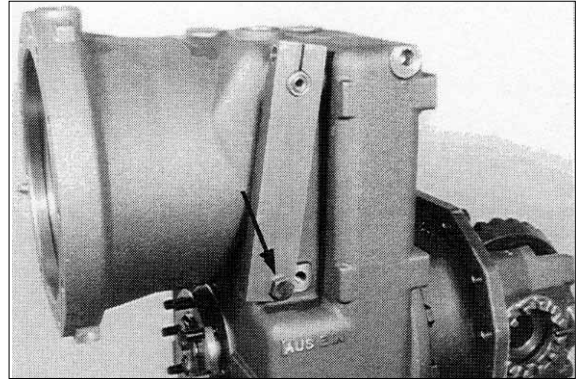

20W78TM132

- (8) Bring shift shaft by clockwise rotation to the stop, using auxiliary screw(M8) and jam shift lever by means of socket head screw(M10) and flat washer.

; Tightening torque : 4.7kgf ; m(33.9lb ; ft)

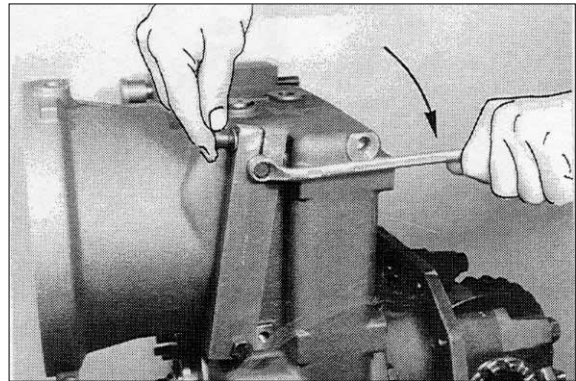

20W78TM133

- (9) Now, bring shift lever in "ON-Position" (Arrow) and fasten by means of hex head screw(M10).

; Tightening torque : 4.7kgf ; m(33.9lb ; ft)

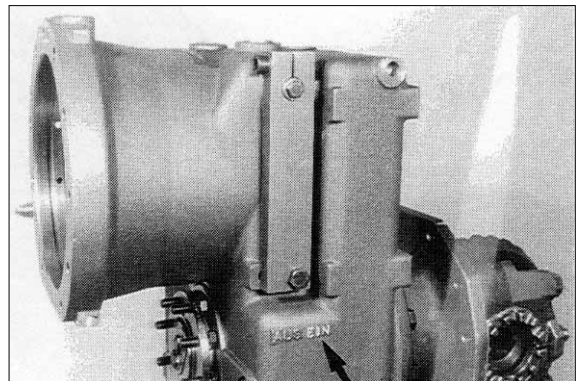

20W78TM134

5) PREASSEMBLE AND INSTALL CLUTCH

(Road gear)

- (1) Press ball bearing firmly against shoulder and fix it by means of circlip.

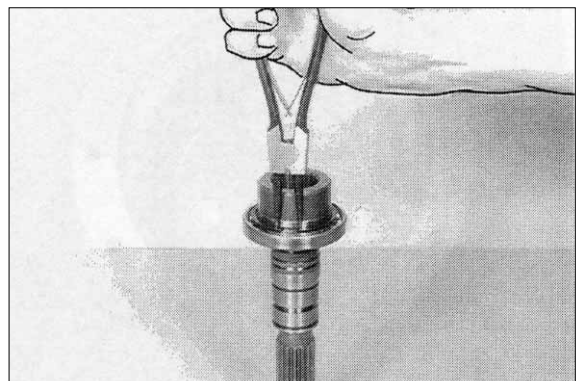

20W78TM135

- (2) Squeeze in the two rectangular rings (Arrows) and engage them.

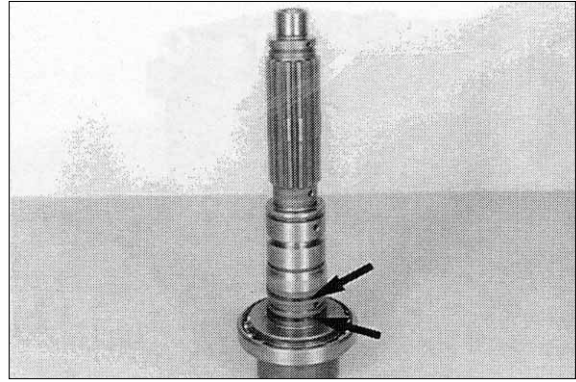

20W78TM136

- (3) Install shaft seal.
i By application of the prescribed driver, the exact installation depth is given. Wet outer diameter of shaft seal with spirit. Grease the sealing lip.

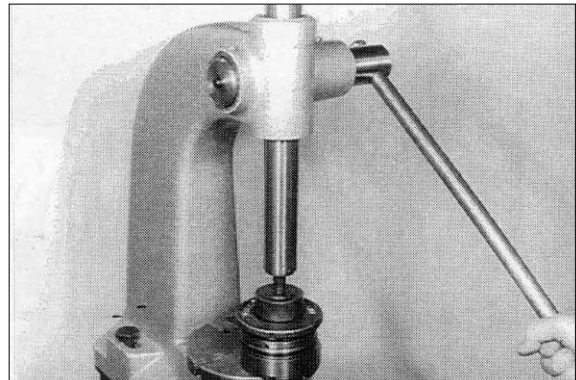

20W78TM137

- (4) Fix shaft seal by means of snap ring.

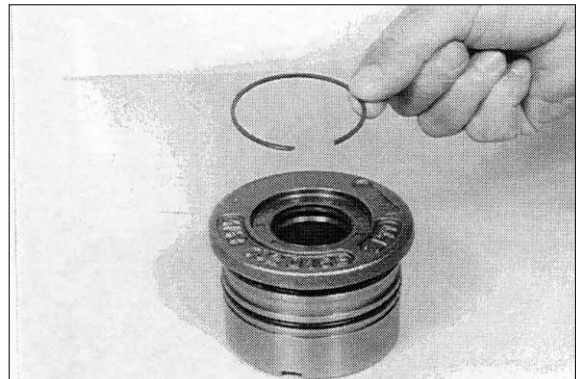

20W78TM138

- (5) Grease the two rectangular rings, align them centrally and press the drive shaft into the guide sleeve until contact is obtained.

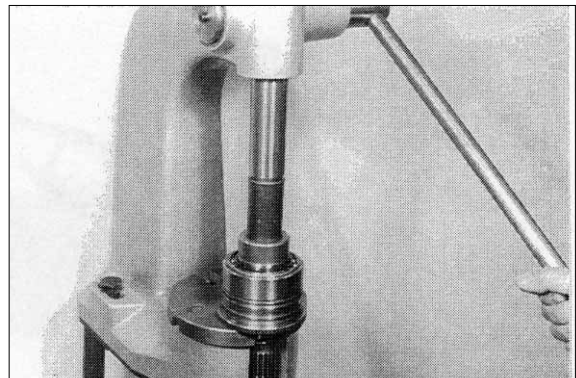

20W78TM139

(6) Fix sleeve by means of circlip.

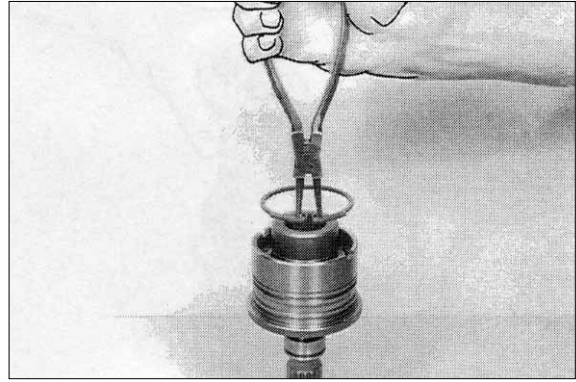

(7) Squeeze in circlip(Arrow) and replace back-up plate, with the offset plane surface showing upwards.

- ; Only installation of one new circlip admitted.

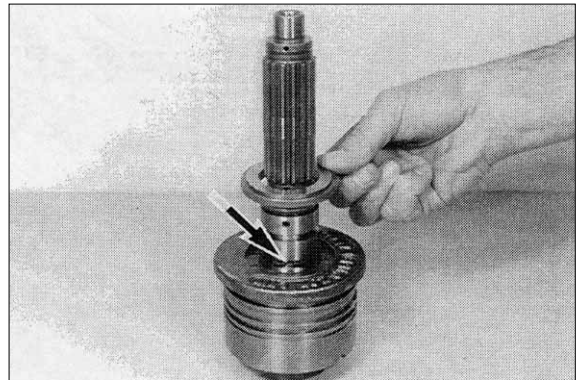

(8) Determine adjustment value "B", follow (9) to (13).

- ; Adjustment value B with 11 plate pairs
= 7.8+0.2mm

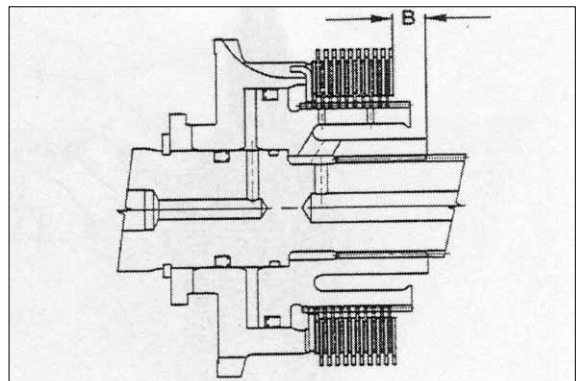

(9) Replace piston.



(10) Assemble plate carrier and tap it against shoulder until contact is obtained.

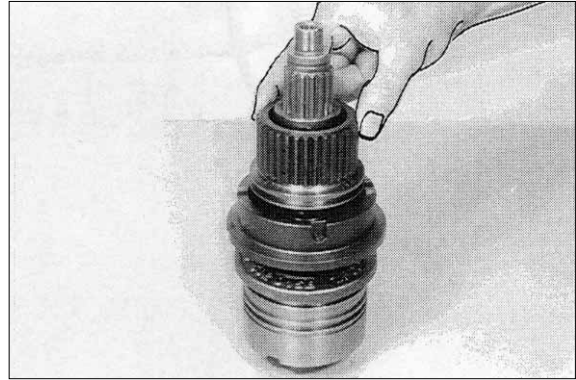

20W78TM144

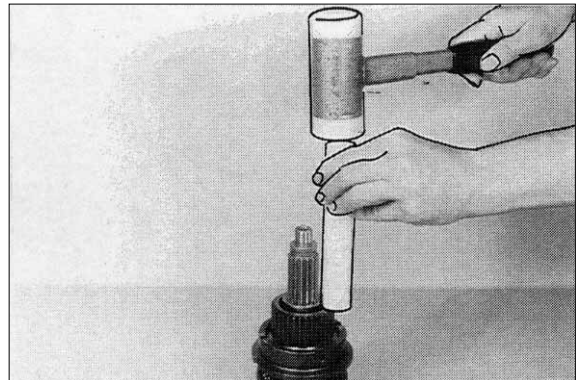

20W78TM145

(11) Mount plate.

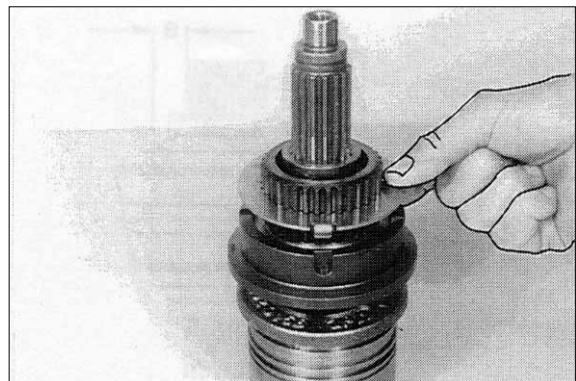

20W78TM146

(12) Assemble alternating plate pack, starting with one inner plate.

- i Number of inner and outer plates, see corresponding list of parts manual. For the moment, install the plate pack without oil.

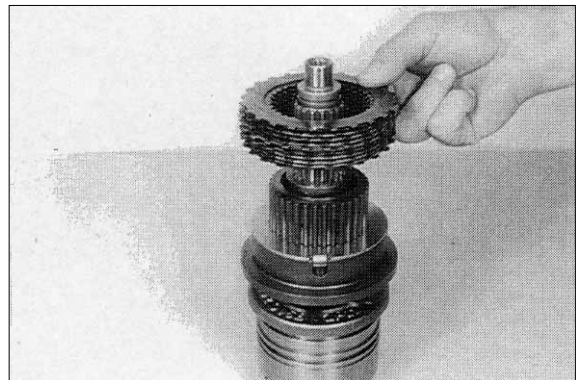

20W78TM147

- (13) Determine dimension B from the end face of the inner plate carrier to the outer plate.
- i Dimension B e.g. : 7.5mm
 - i Carry out any corrections by means of the corresponding outer plates(s = 1.0, 1.2, 1.4 or 1.8mm).

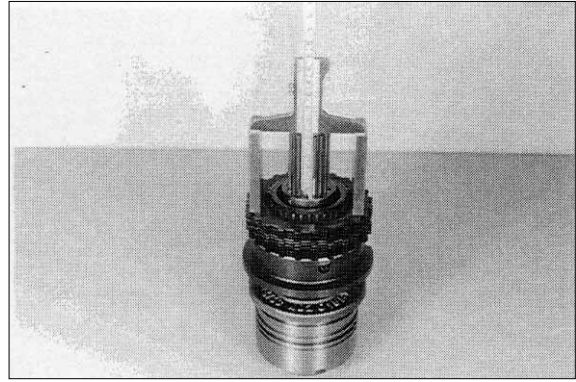

20W78TM148

- (14) Determine adjustment value "D".
- i The end play of plate carrier, ball bearing and sun gear is determined by means of the shim.
- Max end play admitted 0.1mm.
Install ball bearing and sun gear.

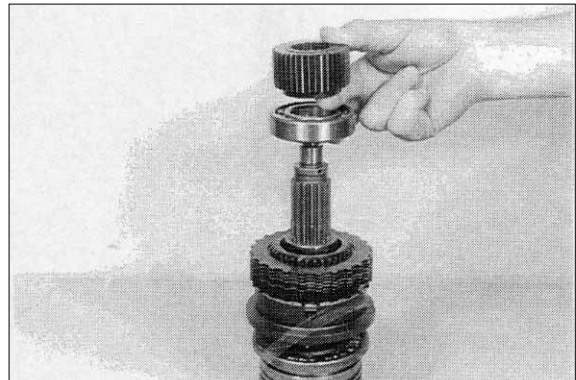

20W78TM149

- (15) Assemble shim(s = 3.0~3.9mm, see Arrow), fix it by means of circlip and check end play.
- Now, squeeze out circlip again and remove the components again, up to the piston included.

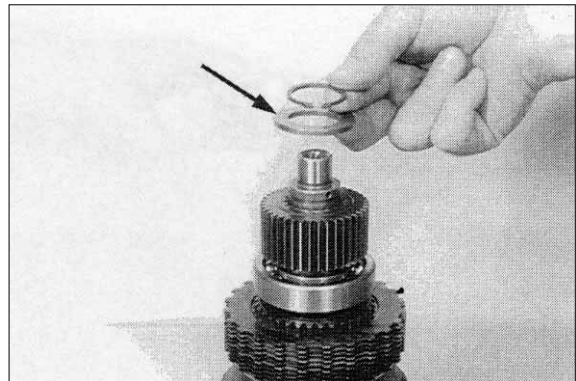

20W78TM150

- (16) Squeeze circlip into the ring groove (Arrow) with the sealing lip facing the pressure chamber(toward above).
- i Use installer.
- Grease sealing lip.

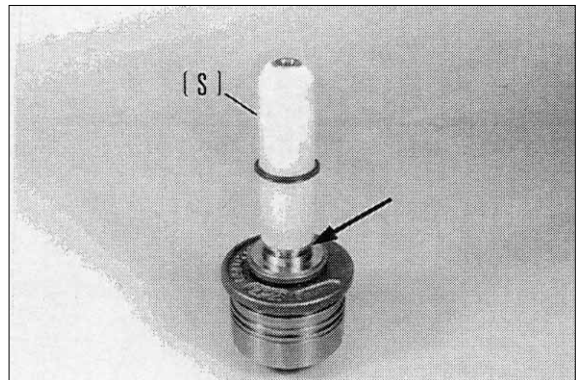

20W78TM151

- (17) Install O-ring, see Arrow.
i Grease O-ring.

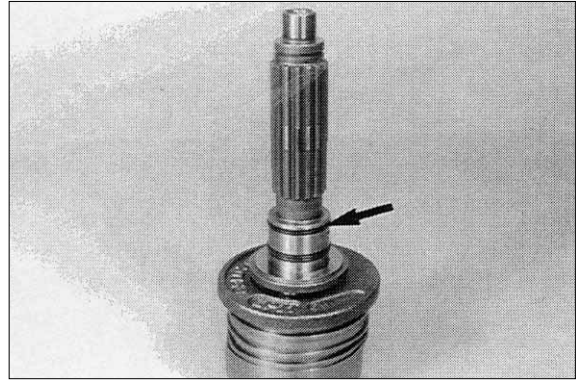

20W78TM152

- (18) Pile cup springs according to the figure.

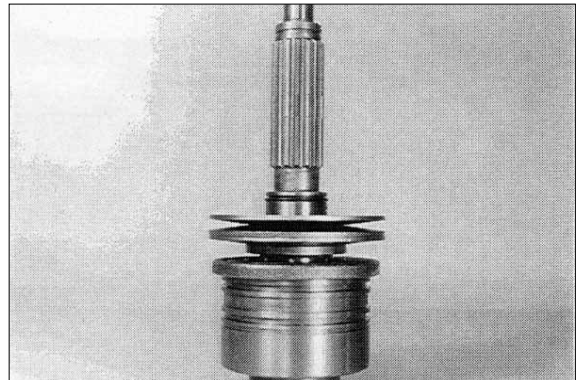

20W78TM153

- (19) Assemble piston.



20W78TM154

- (20) Install seal ring(Arrow) with the sealing lip facing the pressure chamber(Toward below) and insert the inner plate carrier against shoulder, until contact is obtained.
i Grease seal ring.

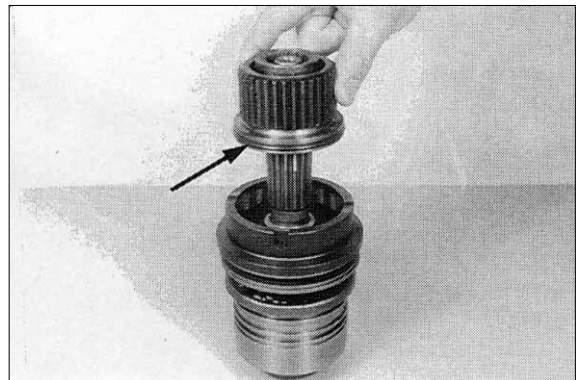

20W78TM155

(21) Mount plate.

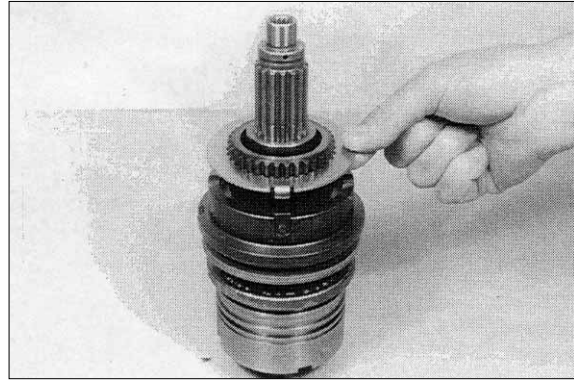

20W78TM156

(22) Assemble plate pack alternating, starting with one inner plate.

- i Number of inner and outer plates see corresponding parts manual.
Oil plates prior to the installation.

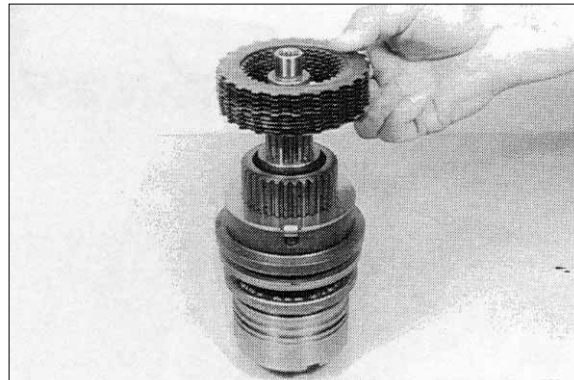

20W78TM157

(23) Insert ball bearing into the centering disk and fix by means of circlip.



20W78TM158

(24) Insert centering disk into the internal gear bore and fix by means of circlip.



20W78TM159

(25) Align outer plates radially and assemble internal gear until all plates are located.



20W78TM160

(26) Assemble sun gear.
i Pay attention to the installation position, see figure.

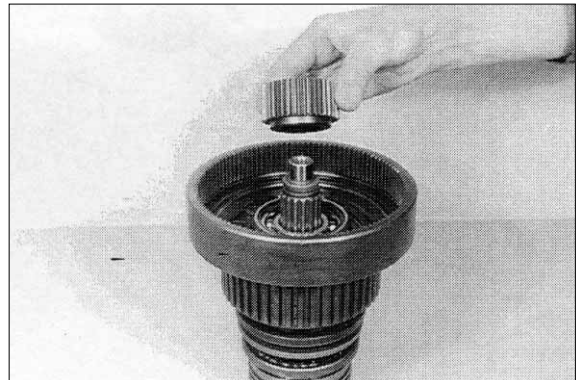

20W78TM161

(27) Mount determined shim.

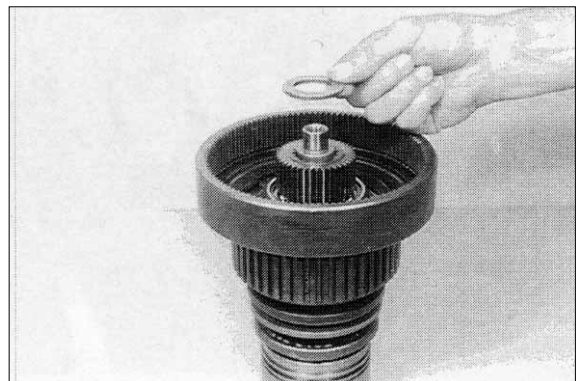

20W78TM162

(28) Preload cup spring pack by means of assembly jig and squeeze in circlip.
i Installation of a new circlip admitted only.

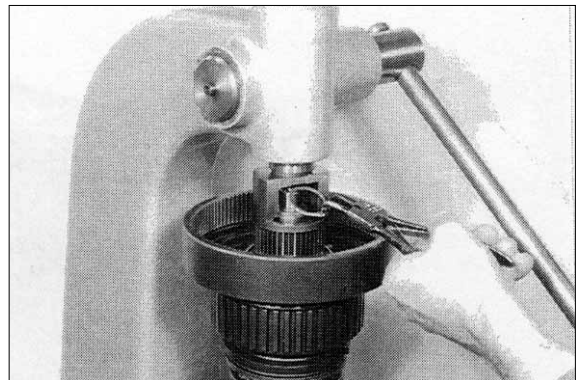

20W78TM163

Check tightness and function of the clutch

(29) Install hydraulic connection.

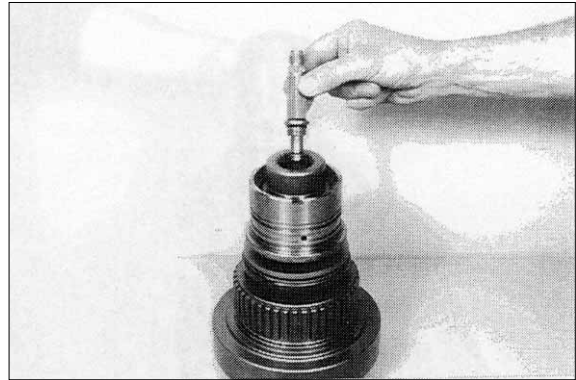

20W78TM164

(30) Ventilate the piston area by repeated filling. Build up test pressure $p=35\text{bar}$ and close connection to HP-Pump by means of shutoff valve.

During a test period of 3 minutes no pressure drop is admitted.

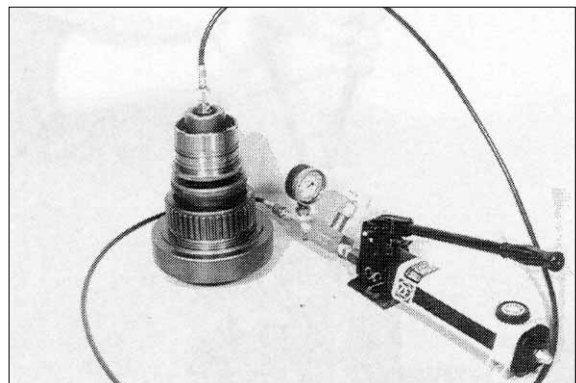

20W78TM165

(31) Remove pressure connection and install throttle valve.

i Install new O-rings, see Arrows.



20W78TM166

(32) Introduce pre-assembled clutch.

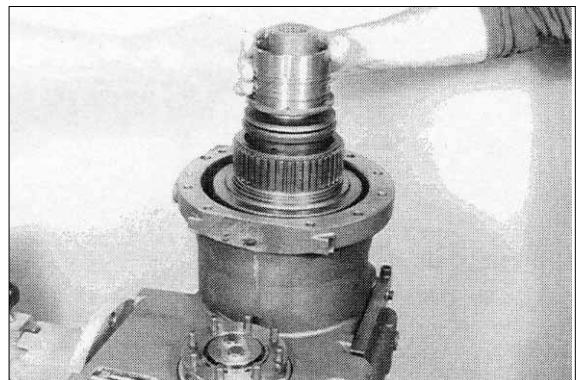

20W78TM167

(33) Squeeze in circlip(190 ; 4).

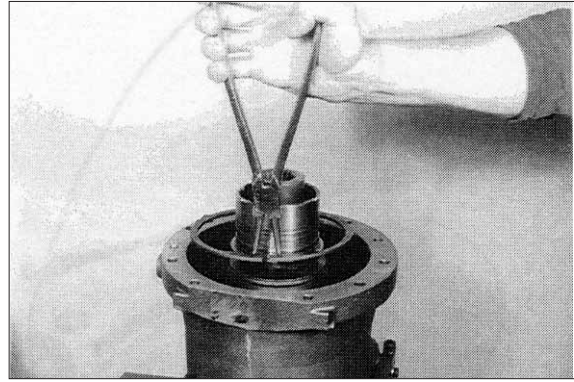

20W78TM168

6) INSTALL BRAKE(Cross-country gear)

(1) Insert backing plate.

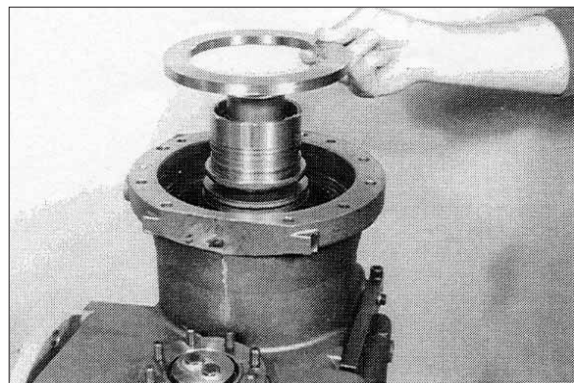

20W78TM169

Determine adjustment dimension "A = 1.4 + 0.2mm" following (2) to Example "E".

(2) Assemble alternating plate pack, starting with one outer plate.

- i Number of outer and inner plates, see corresponding parts manual.
Oil the plates.

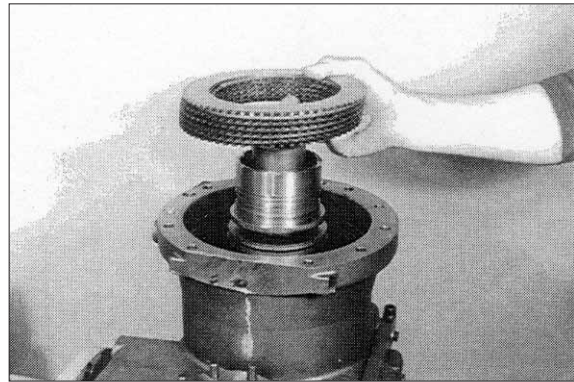

20W78TM170

(3) Insert piston firmly against shoulder.

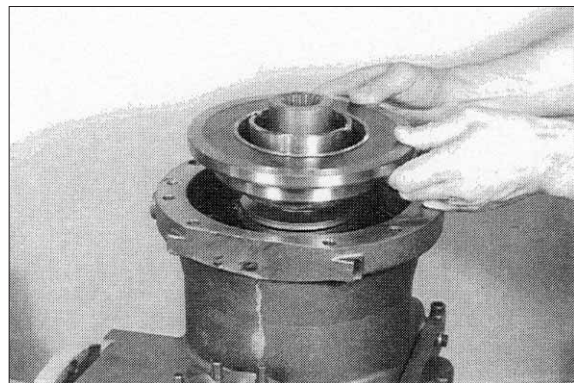

20W78TM171

(4) Insert the two cup springs and align them centrally.

- ; Pay attention to the installation position, see figure.

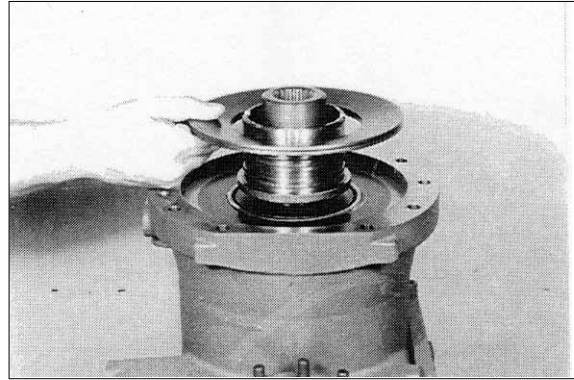

20W78TM172

(5) Assemble measuring cover and pull it evenly against shoulder, using 4 socket head screws(M12).

- ; Tightening torque : 8.0kgf ; m(58.2lb ; ft)

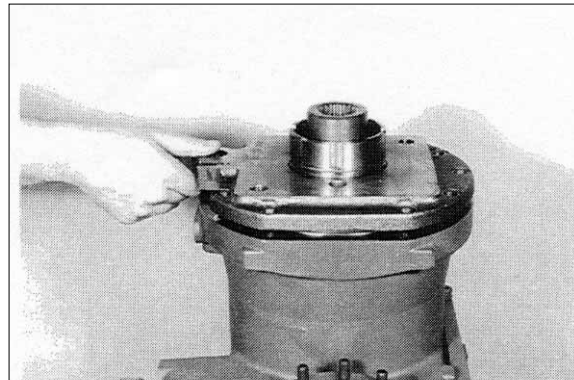

20W78TM173

(6) Determine dimension \varnothing from the plane surface of the measuring cover to the plane surface/piston.

- ; Dimension \varnothing e.g. : 32.60mm

Example D

- ; Dimension 32.60mm

- ; Manufacturing dimension

measuring cover -20.00mm

- ; Difference = Dimension X 12.60mm

- ; The manufacturing dimension is stamped on the measuring cover and is principally 20.00mm.



20W78TM174

(7) Measure dimension Y from the locating face of the drive casing to the flange-mounted surface.

- ; Dimension Y e.g. : 11.10mm

Example E

- ; Dimension X 12.60mm

- ; Dimension Y -11.10mm

- ; Difference ; adjustment value = 1.50mm

- ; Carry out possible corrections with corresponding outer plates(s=3.0, 3.2, 3.5).

Now, take off the measuring cover and remove the piston again.

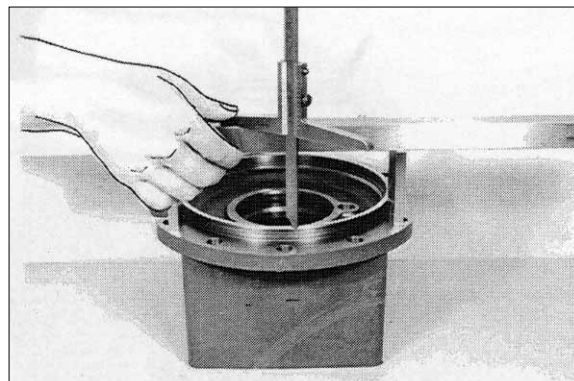

20W78TM175

(8) Insert O-ring in the ring groove of the housing, see Arrow.

- i Expand O-ring slightly prior to the reassembly to ensure a perfect contact in the recess.

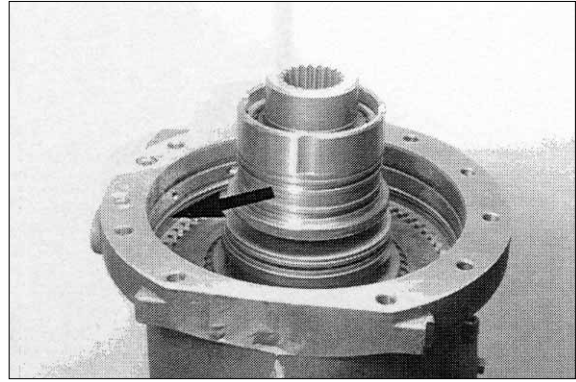

20W78TM176

(9) The Draft on the right shows the installation position of the disk, the piston and its sealing components.

- 1 Drive casing
- 2 Clutch disk housing
- 3,4 Gasket(Back up and U-section ring)
- 5 Circlip
- 6 O-ring
- 7 Disk
- 8,9 Gasket(U section and back up ring)
- 10 Piston
- 11 Cup springs
- 12 O-ring

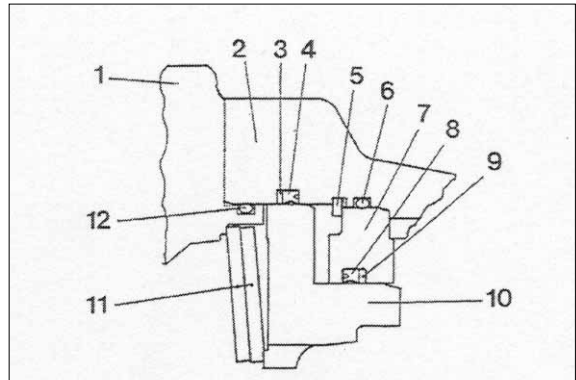

20W78TM177

(10) Insert back-up and U-section ring in the ring groove(Arrow) and oil them
Insert disk until contact is obtained.

- i Pay attention to the installation position.

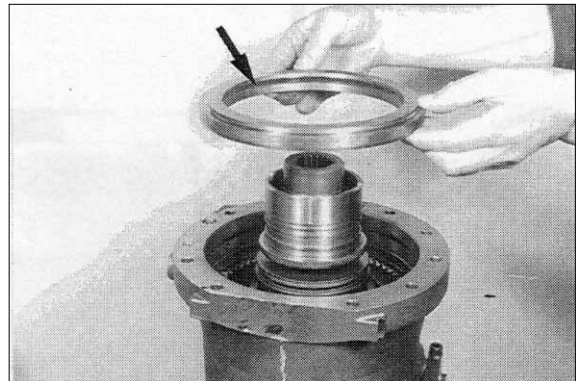

20W78TM178

(11) Fix disk by means of snap ring.

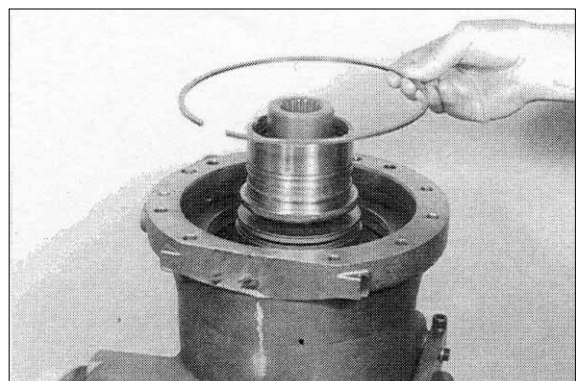

20W78TM179

(12) Insert back-up ring and seal ring in the ring groove of the housing(Arrow) and oil them.

Assemble piston and place it evenly against shoulder, using measuring cover as well as socket head screws. Now, remove measuring cover again.

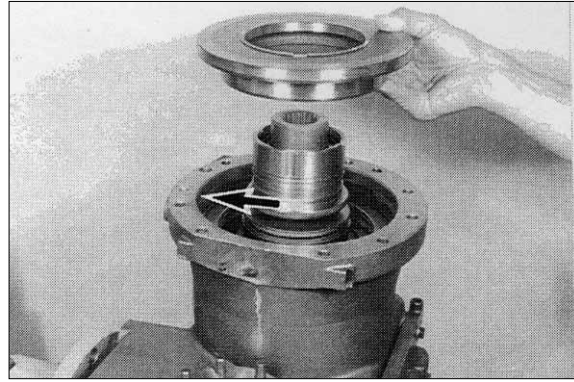

20W78TM180

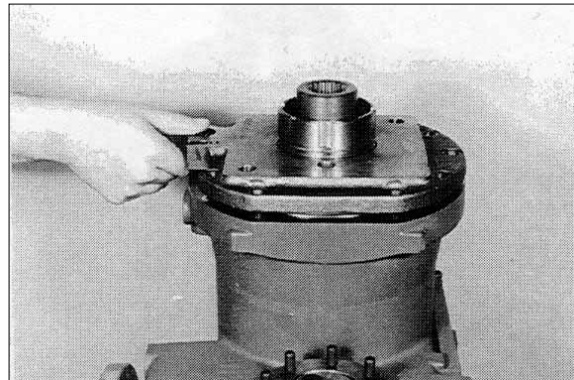

20W78TM181

(13) Insert the two cup springs and align them centrally.

; Pay attention to the installation position.

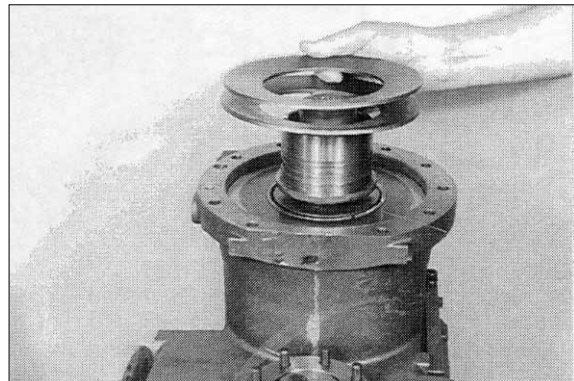

20W78TM182

7) INSTALL DRIVE CASING

(1) Insert O-ring(Arrow 1) in the countersinking.

Insert the two O-rings in the ring grooves of the guide sleeve, see Arrows.

; Grease O-rings.

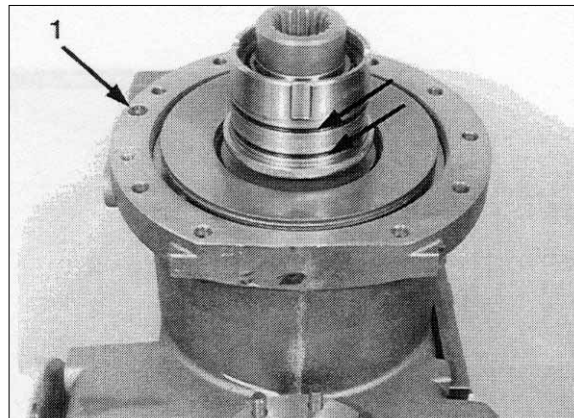

20W78TM183

- (2) Insert O-ring into the ring groove of the drive casing and grease.

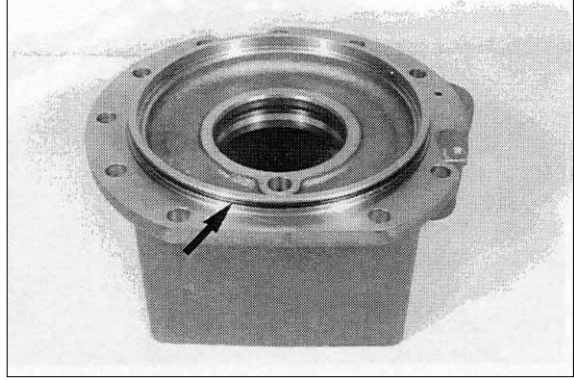

20W78TM184

- (3) Align guide bush radially.

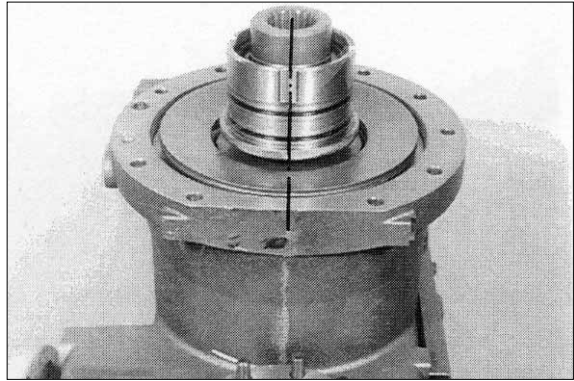

20W78TM185

- (4) Assemble drive casing.
; Pay attention to a radial installation position.

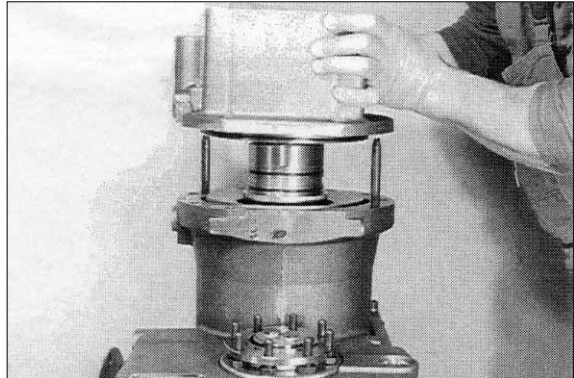

20W78TM186

- (5) Pull drive casing evenly against shoulder, using socket head screws(M12).
; Tightening torque : 8.0kgf ; m(58.2lb ; ft)

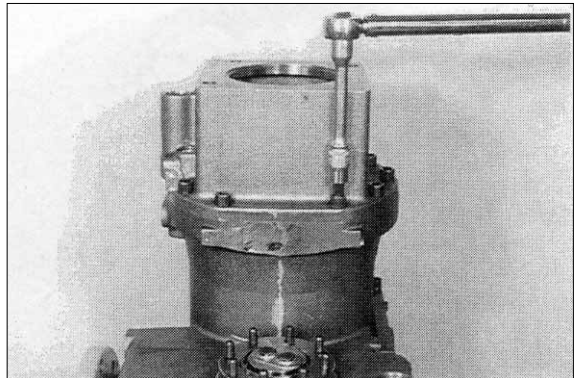

20W78TM187

- (6) Pull drive shaft, resp. guide bush out of the housing bore, using internal puller, until snap ring(Nominal width = 95mm) can be engaged.

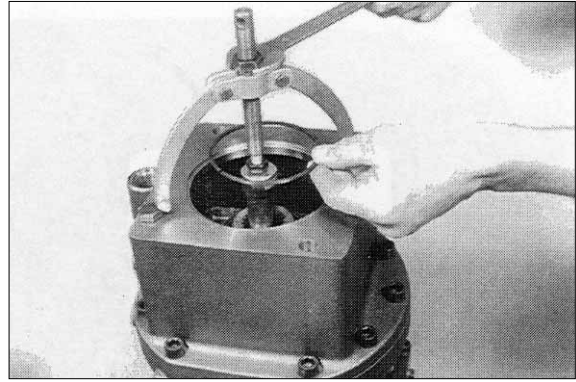

20W78TM188

- (7) Fix guide bush radially by means of screw plug, see Arrow.
i Install new CU-ring.

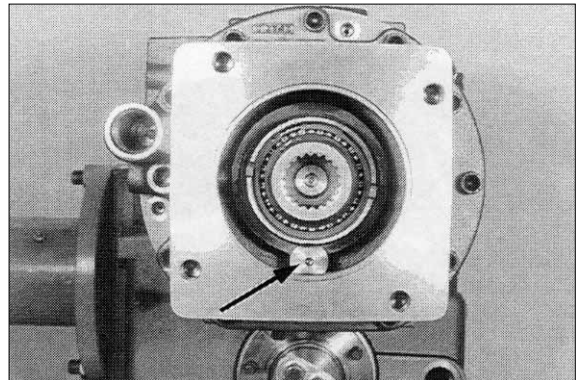

20W78TM189

- (8) Insert gasket, composed of O-ring and Turcon-ring into the ring groove of the piston and grease.
i Heat Turcon-ring in an oil bath prior to the installation.
Use installer.
Pay attention to the installation position, see figure.

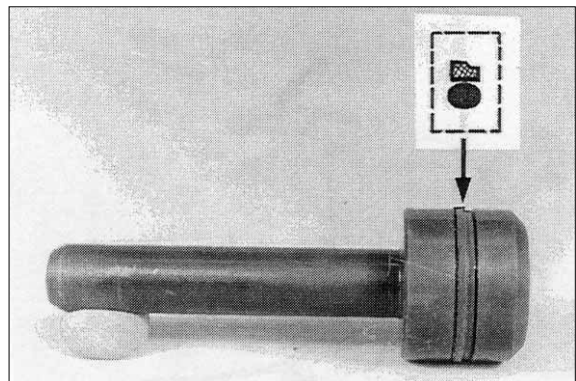

20W78TM190

- (9) Insert pre-assembled piston and spring into the housing bore and fix with screw plug.
i Employ new O-ring for screw plug.

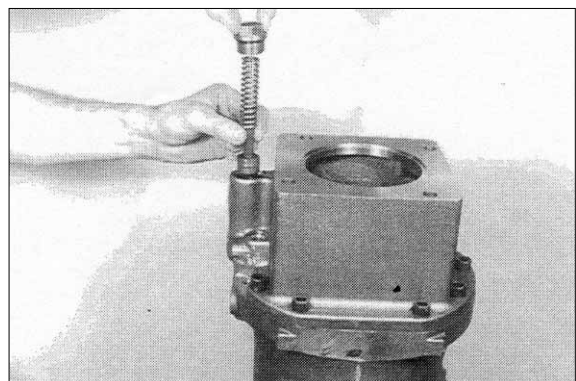

20W78TM191

- (10) install breather(Arrow 1) and screw plug (Arrow 2).
- i Employ new O-ring for screw plug.

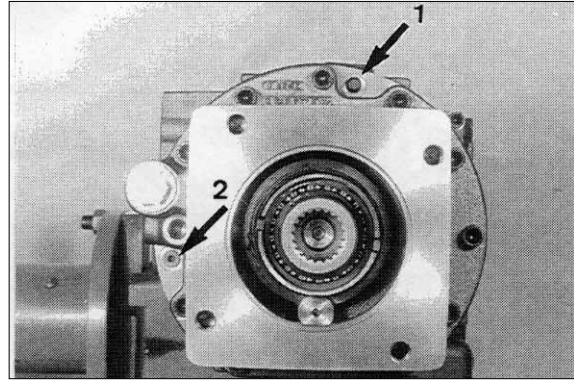

20W78TM192

- (11) Install the two screw plugs(1) and shear-off plugs(2).
Check tightness and function of the brake(Cross-country gear).
 Install hydraulic connection.

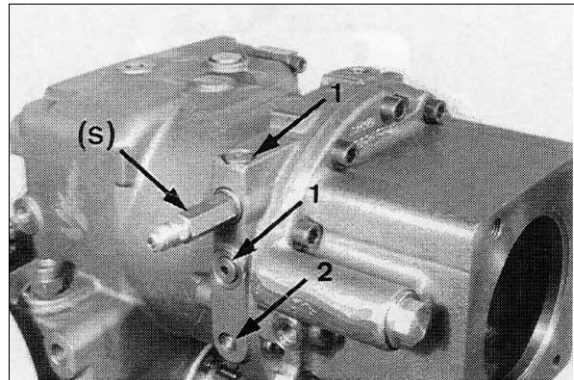

20W78TM193

- (12) Ventilate piston chamber by filling it several times.
 Build up test pressure $p=35\text{bar}$ and close connection to HP-Pump by means of shut-off valve.
 During a Test of 3 minutes, no pressure drop is admitted.

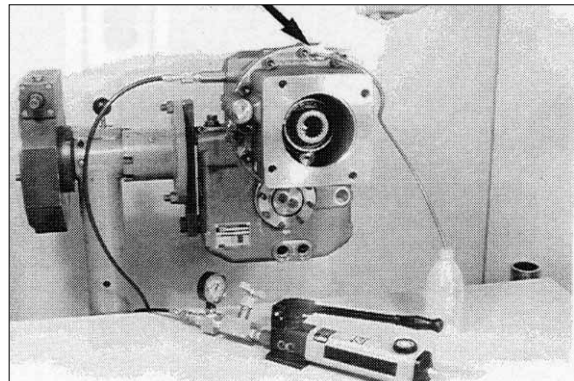

20W78TM194

- (13) Remove the hydraulic connection and install the throttle valve.
 i Install new O-rings(Arrows).

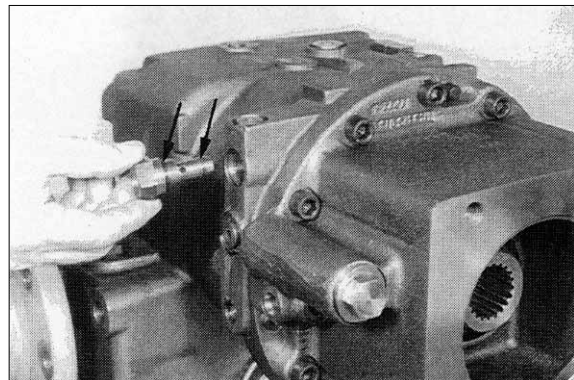

20W78TM195

8) MOUNT SCREW PLUGS AND OIL LINES

(1) Mount suction pipe

i

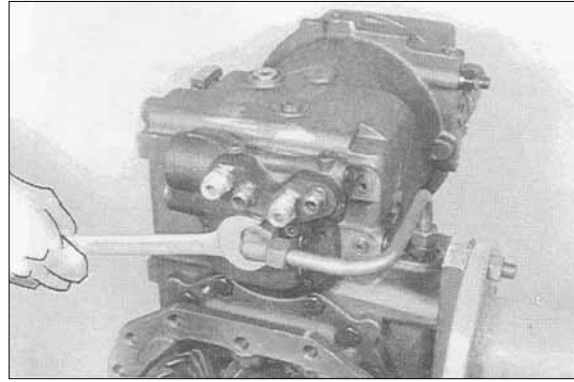

20W78TM199

(2) Install connecting plug(Arrow 1, M10) and screw plug(Arrow 2, M14).

i Tightening torque : 1 - 2.5kgf /m
(18.4lb /ft)

2 - 3.6kgf /m
(25.8lb /ft)

i Install new O-rings.

Different position of connecting piece and screw plug according to the Version.

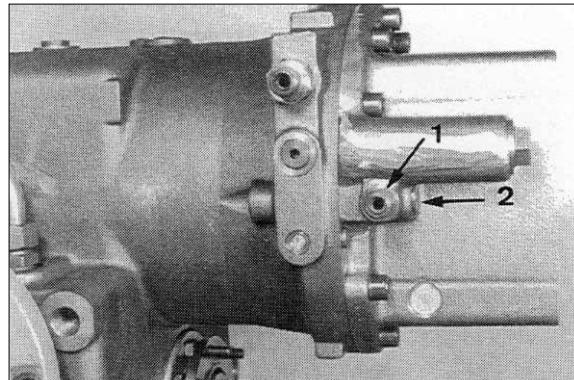

20W78TM196

(3) Install delivery lines.

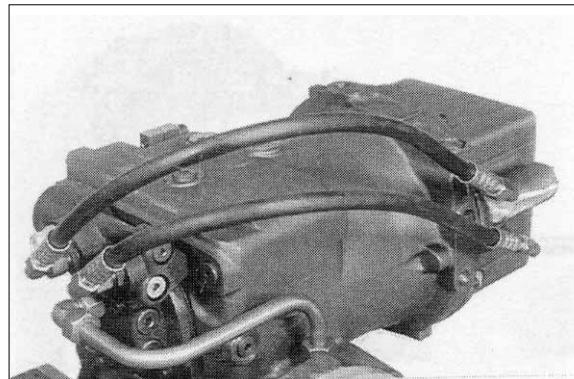

20W78TM197

(4) Install screw plugs(M26 \varnothing 1.5), see Arrows.

i Tightening torque : 8.1kgf /m(59.0lb /ft)

i Before the transmission is put into service, pay attention to the lubrication and maintenance instructions.

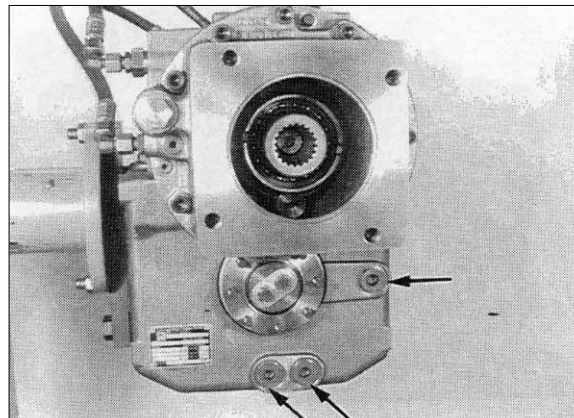

20W78TM198