

## GROUP 7 ENGINE OVERHEAT PREVENTION FUNCTION

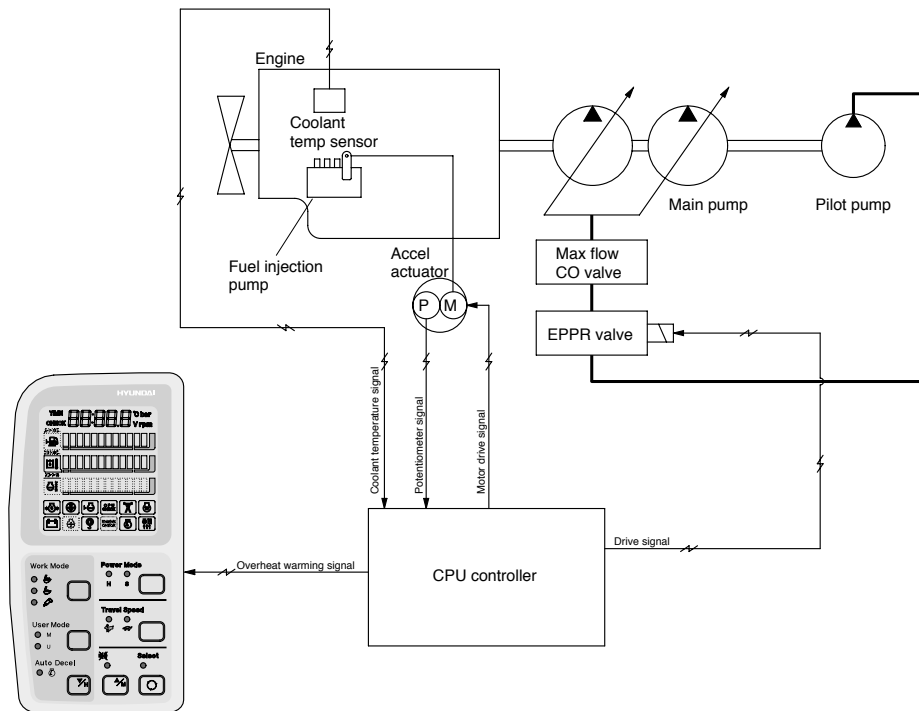

140W75MS09

1. CPU controller reads engine coolant temperature through the temperature sensor and when the engine coolant boils up to 110°C, it sends overheat warning signal to the cluster and decrease the engine speed same as accel dial 7 position.
2. If the coolant temperature drops less than 100°C, the CPU controller returns the mode to the mode set before. And if mode set is changed during the function, the CPU controller cancels the function. Even if the overheat prevention function is canceled by mode change, the overheat warning lamp turns OFF only when the coolant temperature is less than 100°C.

### 3. LOGIC TABLE

Description	Condition	Function
Actuated	- Coolant temperature : Above 110°C - Accel dial set : Above 8	- Engine rpm drop to accel dial 7 position - Overheat warning lamp & buzzer : ON
Canceled	- Coolant temperature : Less than 100°C - Changed mode set by operator If any of the above conditions is applicable, engine overheat prevention function is canceled	- Return to the mode and accel dial set before - Hold on the changed set
Overheat warning lamp	- Coolant temperature : Less than 100°C	- Overheat warning lamp : OFF