

GROUP 3 WORK EQUIPMENT

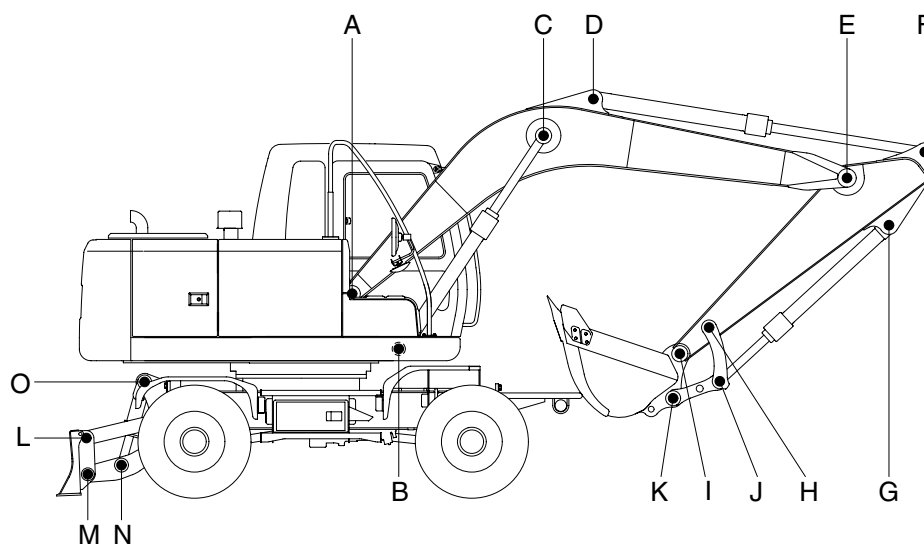

17W77MS14

Unit : mm

Mark	Measuring point (Pin and bushing)	Normal value	Pin		Bushing		Remedy & Remark
			Recomm. service limit	Limit of use	Recomm. service limit	Limit of use	
A	Boom rear	75	74	73.5	75.5	76	Replace
B	Boom cylinder head	70	69	68.5	70.5	71	"
C	Boom cylinder rod	75	74	73.5	75.5	76	"
D	Arm cylinder head	70	69	68.5	70.5	71	"
E	Boom front	75	74	73.5	75.5	76	"
F	Arm cylinder rod	70	69	68.5	70.5	71	"
G	Bucket cylinder head	70	69	68.5	70.5	71	"
H	Arm link	70	69	68.5	70.5	71	"
I	Bucket and arm link	70	69	68.5	70.5	71	"
J	Bucket cylinder rod	70	69	68.5	70.5	71	"
K	Bucket link	70	69	68.5	70.5	71	"
L	Dozer link(B)	60	59	58.5	60.5	61	"
M	Dozer link(A)	60	59	58.5	60.5	61	"
N	Dozer cylinder rod	70	69	68.5	70.5	71	"
O	Dozer cylinder head	70	69	68.5	70.5	71	"