

SECTION 5 MECHATRONICS SYSTEM

Group 1 Outline	5-1
Group 2 Mode Selection System	5-3
Group 3 Automatic Deceleration System	5-6
Group 4 Power Boost System	5-7
Group 5 Travel Speed Control System	5-8
Group 6 Automatic Warming Up Function	5-9
Group 7 Engine Overheat Prevention Function	5-10
Group 8 Anti-Restart System	5-11
Group 9 Self-Diagnostic System	5-12
Group 10 Engine Control System	5-15
Group 11 EPPR(Electro Proportional Pressure Reducing) Valve	5-22
Group 12 Monitoring System	5-25

SECTION 5 MECHATRONICS SYSTEM

GROUP 1 OUTLINE

The NEW CAPO(Computer Aided Power Optimization) system controls engine and pump mutual power at an optimum and less fuel consuming state for the selected work by mode selection, auto-deceleration, power boost function, etc. It monitors machine conditions, for instance, engine speed, coolant temperature, hydraulic oil temperature, and hydraulic oil pressure, etc.

It consists of a CPU controller, a cluster, an accel actuator, an EPPR valve, and other components. The CPU controller and the cluster protect themselves from over-current and high voltage input, and diagnose malfunctions caused by short or open circuit in electric system, and display error codes on the cluster.

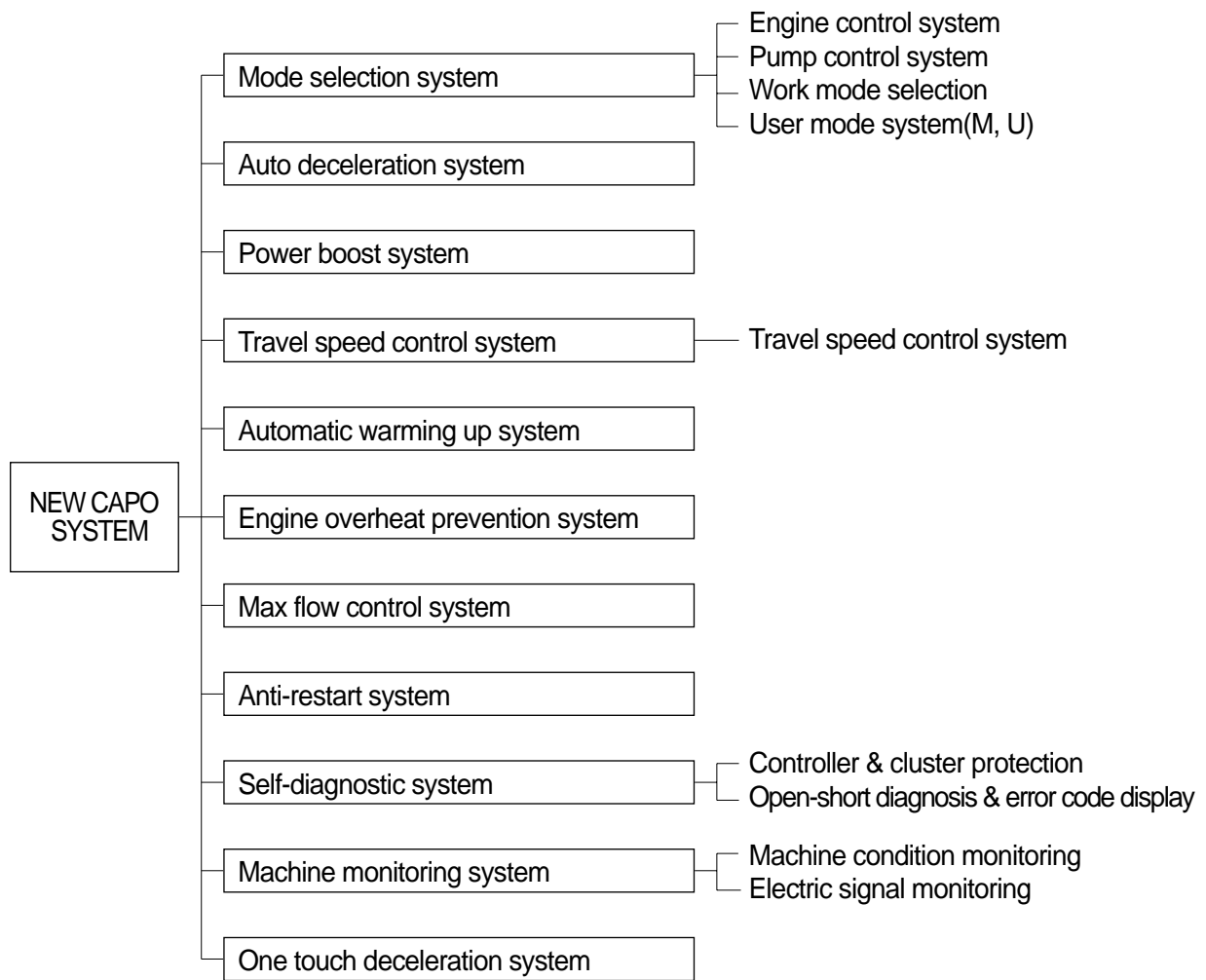

SYSTEM DIAGRAM

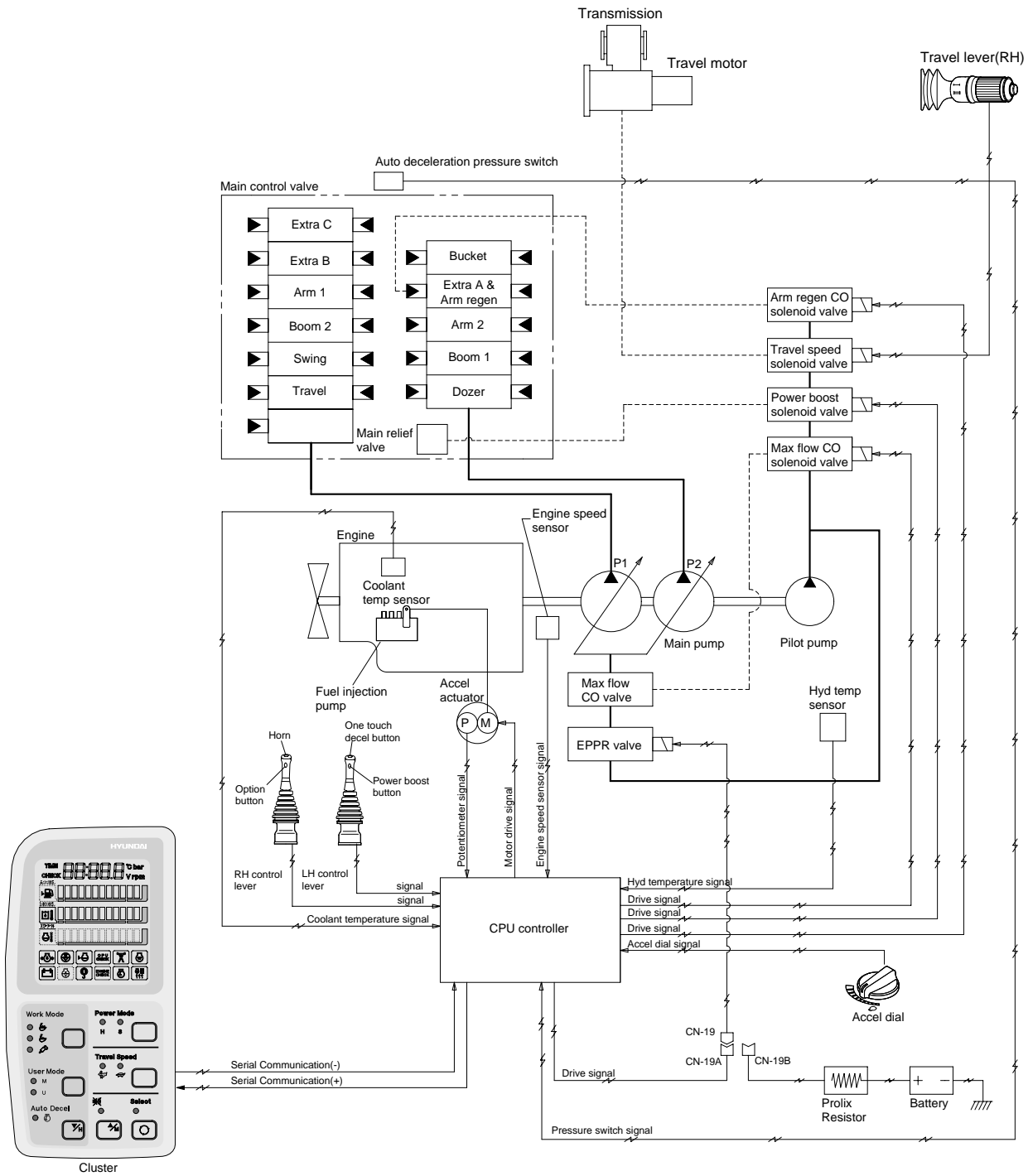

17W75MS01