

GROUP 6 TRAVEL DEVICE

1. REMOVAL AND INSTALL

1) REMOVAL

- (1) Swing the work equipment 90° and lower it completely to the ground.
- (2) Operate the control levers and pedals several times to release the remaining pressure in the hydraulic piping.
- (3) Loosen the breather slowly to release the pressure inside the hydraulic tank.

▲ Escaping fluid under pressure can penetrate the skin causing serious injury.

※ When pipes and hoses are disconnected, the oil inside the piping will flow out, so catch it in oil pan.

- (4) Remove the track shoe assembly.
For details, see **removal of track shoe assembly**.
- (5) Remove the cover.
- (6) Remove the hose.
※ Fit blind plugs to the disconnected hoses.
- (7) Remove the bolts and the sprocket.
- (8) Sling travel device assembly (1).
- (9) Remove the mounting bolts (2), then remove the travel device assembly.
· Weight : 300 kg (660 lb)

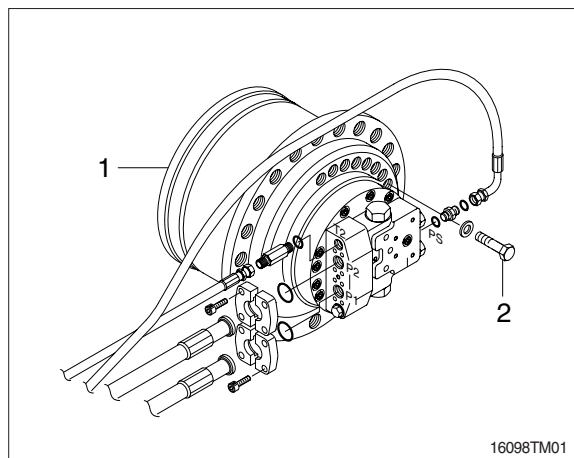

2) INSTALL

- (1) Carry out installation in the reverse order to removal.
- (2) Bleed the air from the travel motor.
 - ① Remove the air vent plug.
 - ② Pour in hydraulic oil until it overflows from the port.
 - ③ Tighten plug lightly.
 - ④ Start the engine, run at low idling, and check oil come out from plug.
 - ⑤ Tighten plug fully.
- (3) Confirm the hydraulic oil level and check the hydraulic oil leak or not.

2. TRAVEL MOTOR

1) STRUCTURE

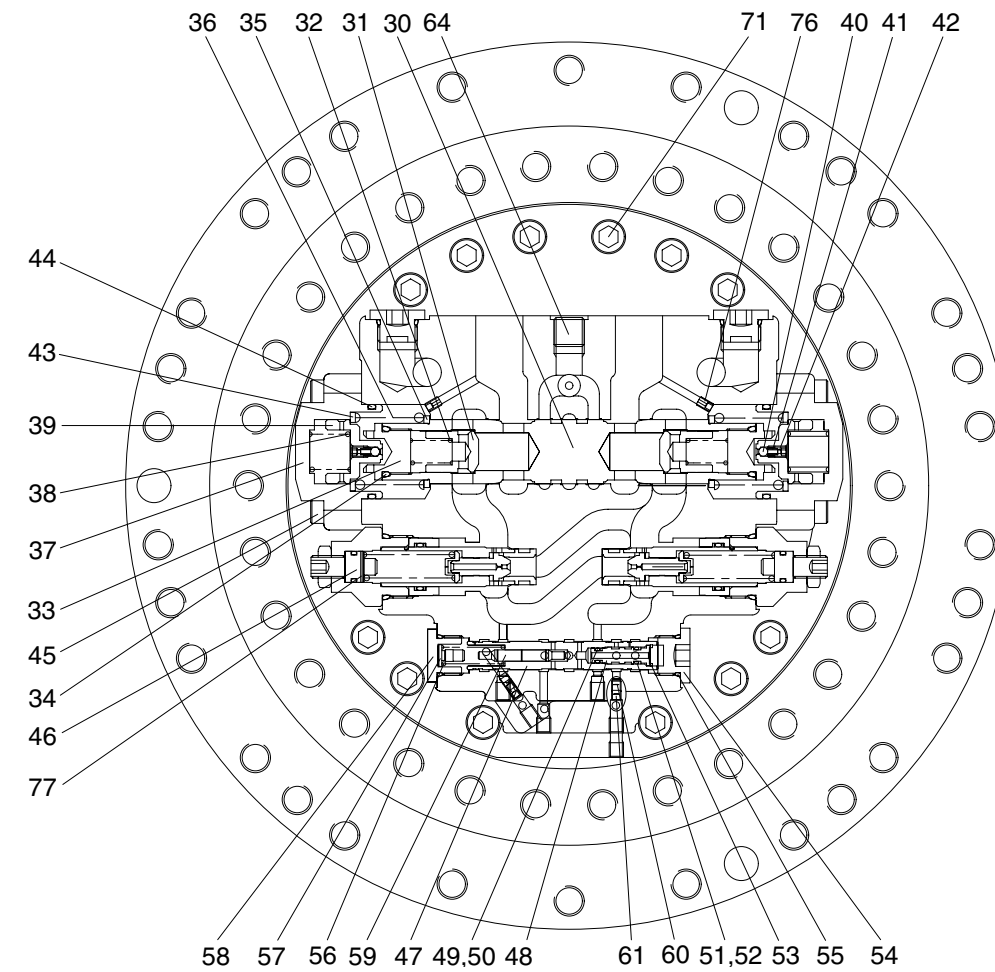
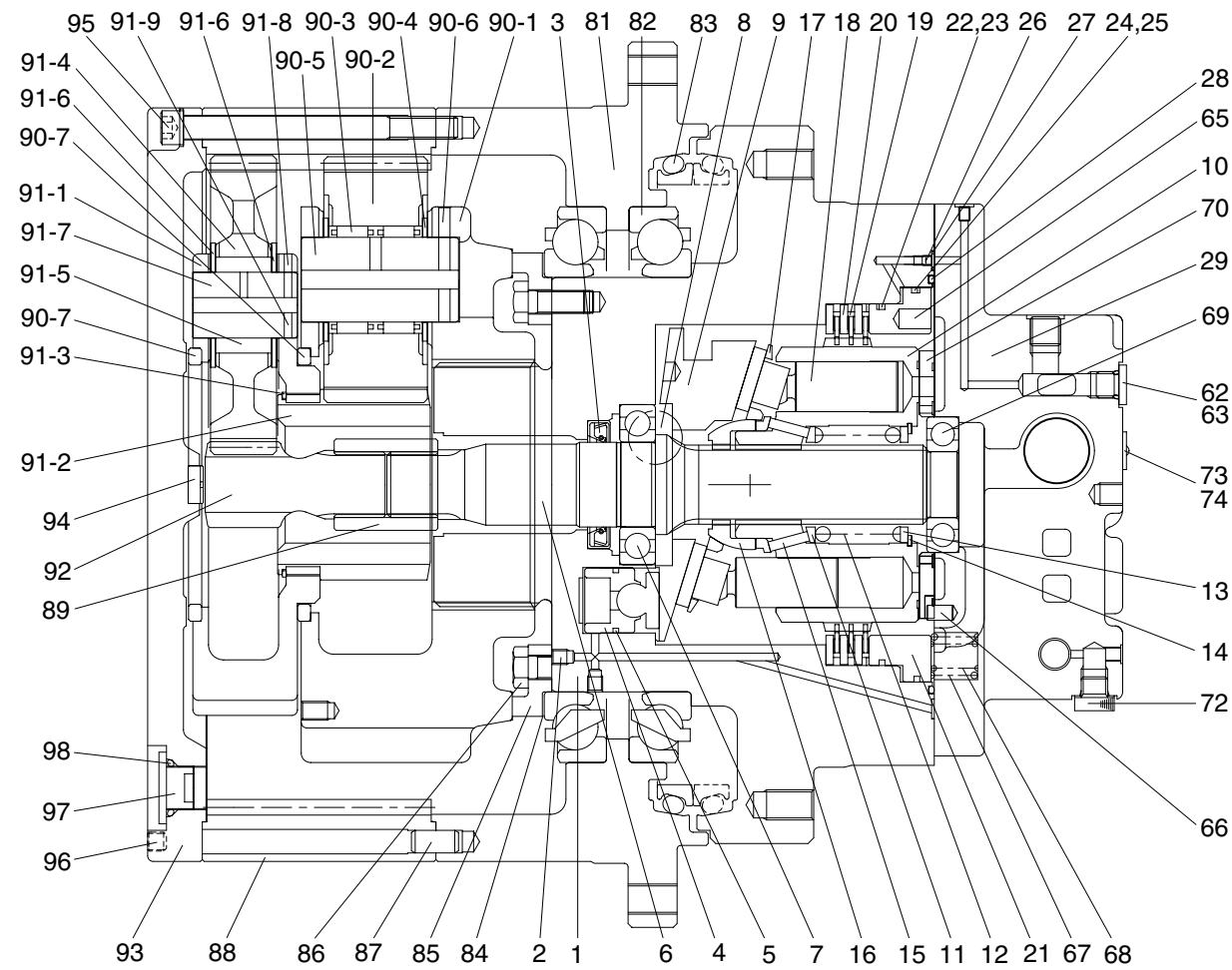

1	Shaft casing	20	Separate plate	39	Spool	58	Plug	77	Shim	91-1	Carrier No.1
2	Plug	21	Parking piston	40	Steel ball	59	Spool	81	Housing	91-2	Sun-gear No.2
3	Oil seal	22	O-ring	41	Spring	60	Orifice	82	Main bearing	91-3	Retaining ring
4	Swash piston	23	Back up ring	42	Plug	61	Orifice	83	Floating seal	91-4	Planetary gear No.1
5	Piston ring	24	O-ring	43	Spring seat	62	Plug	84	Shim	91-5	Needle bearing No.1
6	Shaft	25	Back up ring	44	O-ring	63	O-ring	85	Retainer	91-6	Thrust washer
7	Bearing	26	Orifice	45	Wrench bolt	64	Plug	86	Hex head bolt	91-7	Pin No.1
8	Steel ball	27	O-ring	46	Relief valve assy	65	Pin	87	Parallel pin	91-8	Spring pin
9	Swash plate	28	O-ring	47	Spool	66	Pin	88	Ring gear	91-9	Spring pin
10	Cylinder block	29	Rear cover	48	Guide	67	Spring	89	Coupling	92	Sun gear No.1
11	Spring seat	30	Spool	49	O-ring	68	Spring	90	Carrier assy No.2	93	Cover
12	Spring	31	Check	50	Back up ring	69	Bearing	90-1	Carrier No.2	94	Pad
13	End plate	32	Spring	51	O-ring	70	Valve plate	90-2	Planetary gear No.2	95	Hex socket head bolt
14	Snap ring	33	Plug	52	Back up ring	71	Wrench bolt	90-3	Needle bearing No.2	96	Hex socket Screw
15	Pin	34	O-ring	53	Snap ring	72	Plug	90-4	Thrust washer	97	Hydraulic plug
16	Ball guide	35	Spring seat	54	plug	73	Name plate	90-5	Pin No.2	98	O-ring
17	Set plate	36	Spring	55	O-ring	74	Rivet	90-6	Spring pin	99	Name plate
18	Piston assy	37	Cover	56	Spring	75	Seal kit	90-7	Thrust ring		
19	Friction plate	38	Spring	57	Spring seat	76	Orifice	91	Carrier assy No.1		

16092TM02

2) TOOLS AND TIGHTENING TORQUE

(1) Tools

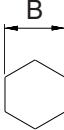
Tool name		Remark	
Allen wrench		2.5, 4, 6, 10	
Socket for socket wrench, spanner	Socket	8, 14, 24, 27	
Torque wrench		Capable of tightening with the specified torques	
Pliers		-	
Plastic and iron hammer		Wooden hammer allowed. Normal 1 or so	
Monkey wrench		-	
Oil seal inserting jig		-	
Bearing pliers		-	
Seal tape		-	
Eye bolt		M10, M12, M14	
Press (0.5 ton)		-	
Oil stone		-	
Bearing assembling jig		-	

(2) Tightening torque

Part name	Item	Size	Torque	
			kgf · m	lbf · ft
Plug	2	NPT 1/16	1 ± 0.1	7.2 ± 0.7
Orifice	26	M5	0.7 ± 0.1	5 ± 0.7
Wrench bolt	45	M12 × 40	10 ± 1.0	72 ± 7.0
Relief valve	46	HEX 27	18 ± 1.0	130 ± 7.0
Plug	54	PF 1/2	8.5 ± 1.0	61 ± 7.0
Plug	58	HEX 24	5 ± 1.0	36 ± 7.0
Plug	62	PF 1/4	5 ± 1.0	36 ± 7.0
Wrench bolt	71	M12 × 35	10 ± 1.0	72 ± 7.0
Hex head bolt	-	M12 × 25	11 ± 1.5	79 ± 10
Hex socket head bolt	-	M12 × 155	11 ± 1.5	79 ± 10
Hex socket head plug	-	PF 3/4	19 ± 1	137 ± 7.0

3. OUTLINE OF DISASSEMBLING

1) GENERAL SUGGESTIONS

- (1) Select a clean place for dismantling.
Spread a rubber plate on a working table in order to prohibit the damage of parts.
- (2) Clean a deceleration equipment and a motor part, washing out dirt and unnecessary substances.
- (3) Without any damage of O-ring, oil seal, the adhered surface of other seals, a gear, a pin, the adhered surface of other bearings, and the surface of moisturized copper, treat each parts.
- (4) Numbers written in the parenthesis, (), next to the name of a part represent the part numbers of a cross-sectional view annexed with a drawing.
- (5) The side of a pipe in a motor can be written as a rear side; the side of out-put as a front side.
- (6) Using and combining a liquid gasket, both sides must be dried completely before spraying a liquid gasket.
- (7) In case of bonding bolts, combine a standard torque by torque wrench after spraying loctite 262 on the tab parts. (It can be dealt as assembling NPTF screws and an acceleration equipment.)

3.1 DISASSEMBLING

- 1) Unloosing wrench bolt and disassemble cover (37).
※ Wrench bolt = M12 × 40L-8EA
(purchasing goods)

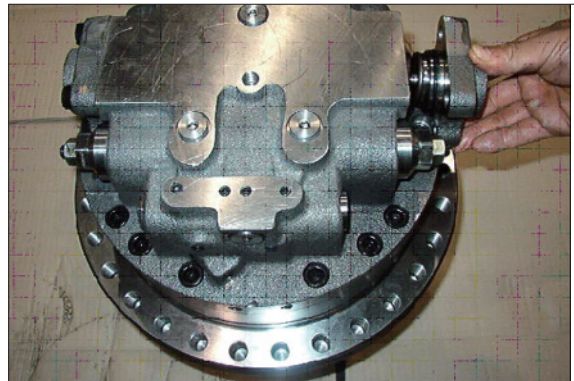

21078TM21

- 2) Disassemble parts related to C.B.V.



21078TM22

- 3) Unloosing wrench bolt (M12×35L, 16EA) and disassemble rear cover assembly from motor assembly.

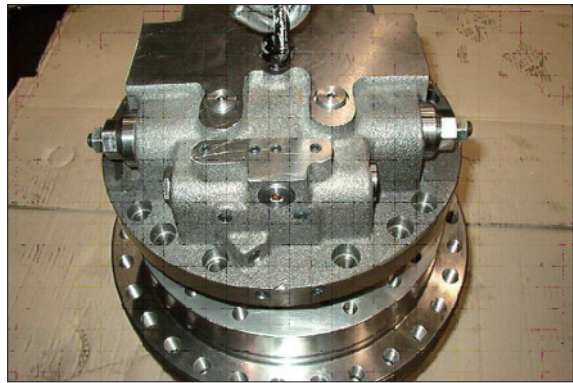

21078TM23

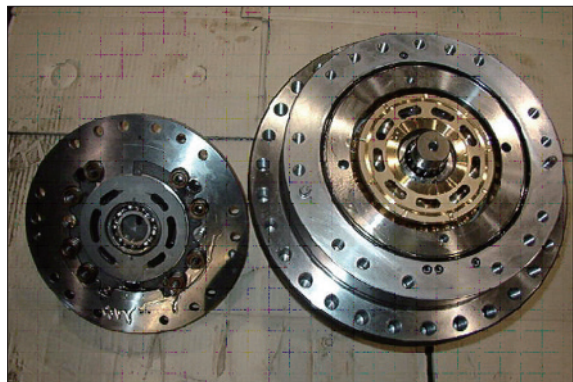

21078TM24

- 4) Dismantle packing piston (21) using compressed air.

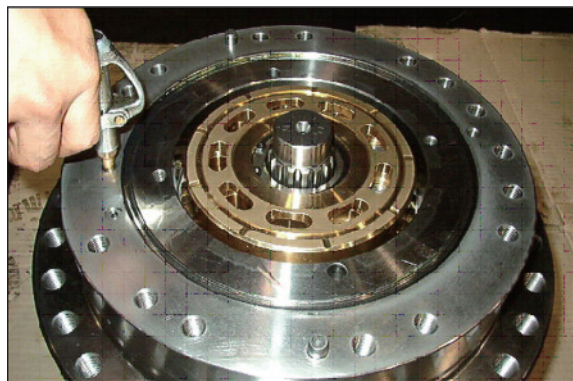

21078TM25

- 5) Disassembly rotary kit from motor assembly (cylinder block assembly, piston assembly, ball guide, set plate, friction plate, steel plate...)

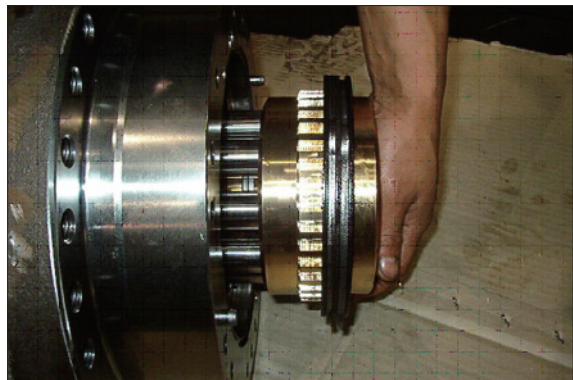

21078TM26

6) Using a jig, disassemble swash plate (9) from shaft casing.

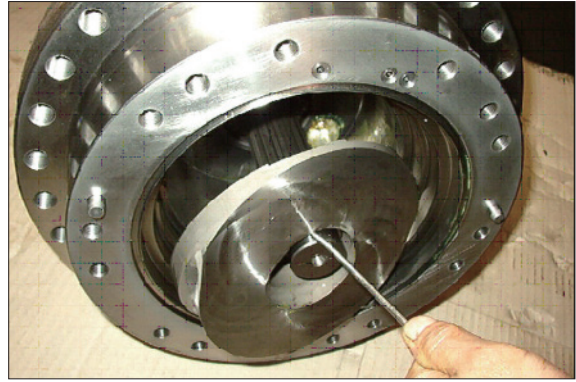

21078TM27

7) Using compressed air, disassemble piston swash (4) piston ring (5), respectively.

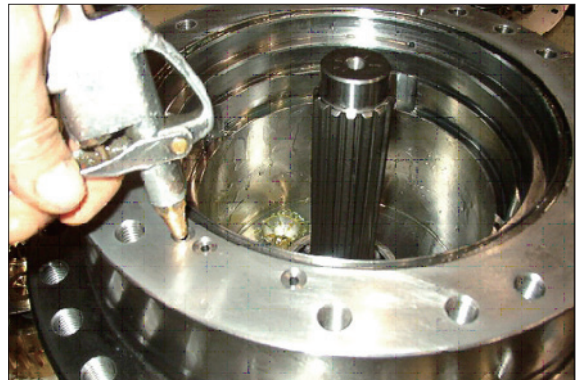

21078TM28



21078TM29

8) Using a hammer, disassemble shaft (6) from shaft casing (1).

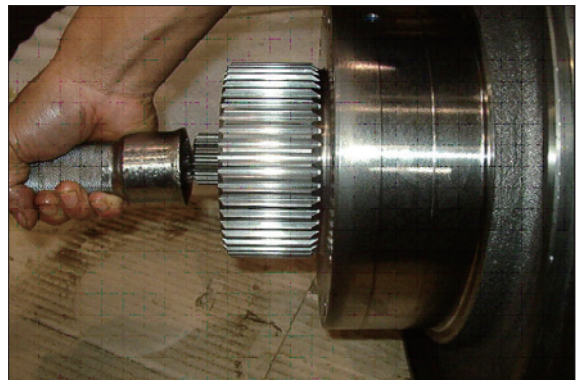

21078TM30

■ Disassemble cylinder sub.

9) Disassemble cylinder block assembly, piston assembly (9) and seat plate (M).

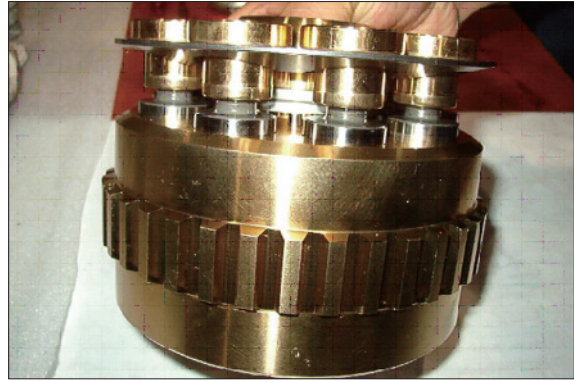

21078TM31



21078TM32

10) Disassemble ball guide (16), ring and pin (15) from cylinder block, respectively.

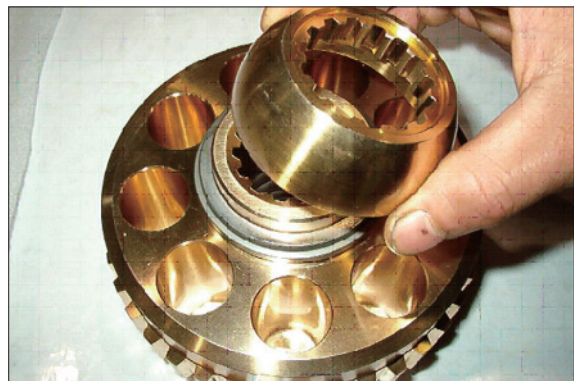

21078TM33

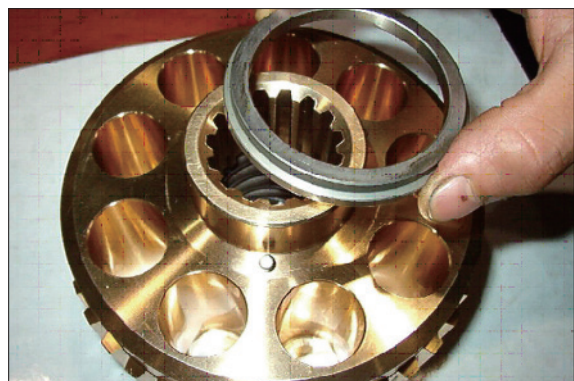

21078TM34

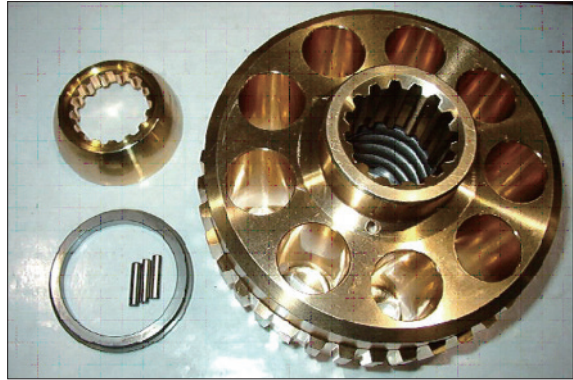

21078TM35

11) Pushing spring (12) by an assembling jig, disassemble snap ring (14), spring seat (13), spring (12) and spring seat (11), respectively.

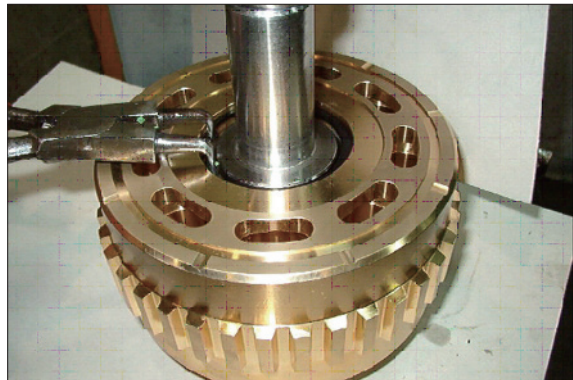

21078TM36



21078TM37

■ **Disassemble valve casing sub.**

12) Using an hexagon wrench, unloosing wrench bolt (45) and disassemble cover (37), spring (38), spool (39), spring seat (43), spring (36) and spring seat (35), respectively.
(Same balance on both sides)

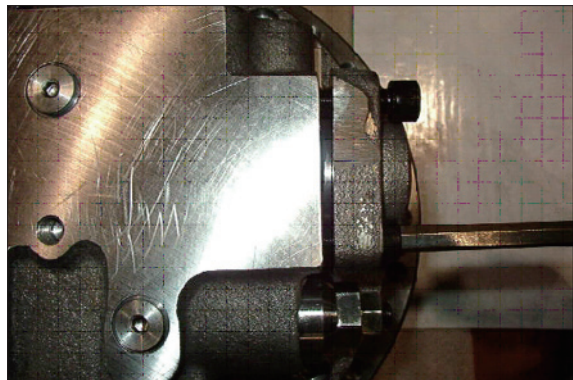

21078TM38

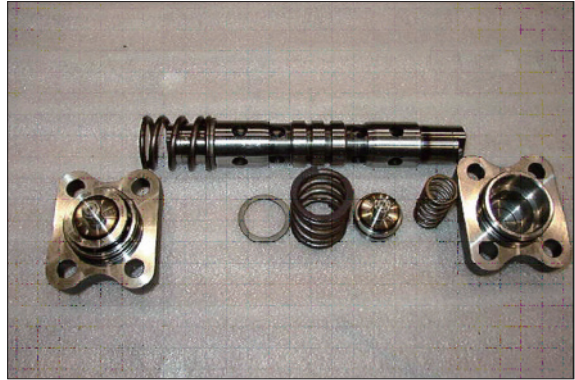

21078TM39

13) Disassemble spool (59), spool (47), O-ring (51), guide (48) and snap ring (53) on rear cover, respectively.

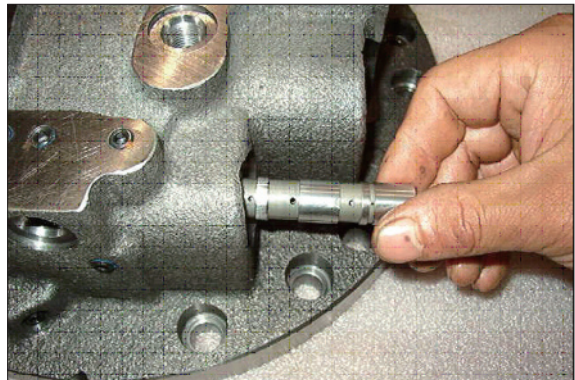

21078TM40



21078TM41

14) Using a torque wrench, disassemble relief assembly (46) on rear cover.

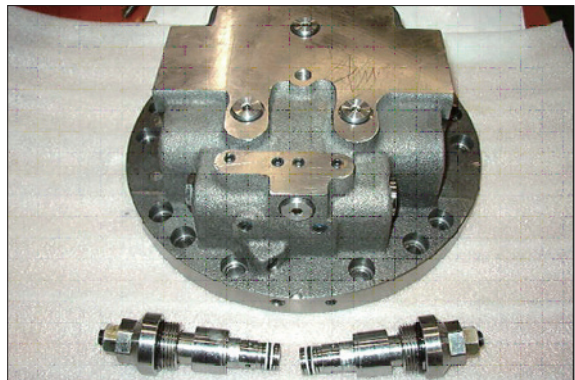

21078TM42

4. OUTLINE FOR ASSEMBLING

1) GENERAL SUGGESTIONS

- (1) After washing each parts cleanly, dry it with compressed air.
Provided that you do not wash friction plate with treated oil.
- (2) In bonding each part, fasten bond torque.
- (3) When using a hammer, do not forget to use a plastic hammer.

4.1 ASSEMBLING

■ Assemble the sub of turning axis

- 1) Using a jig, assemble oil seal (3) into shaft casing (1)

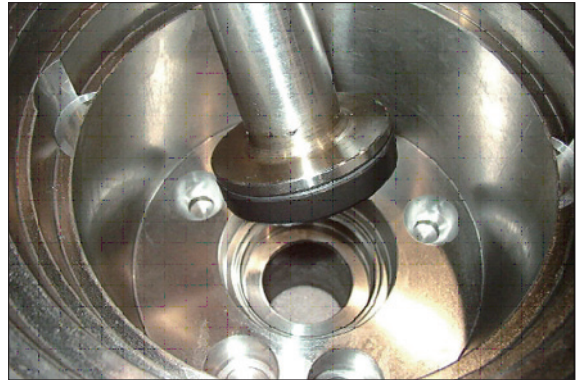

21078TM43

- 2) Have a bearing (8) thermal reacted into shaft (6).



21078TM44

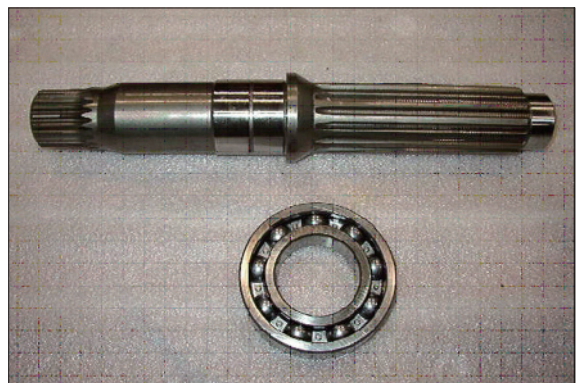

21078TM45

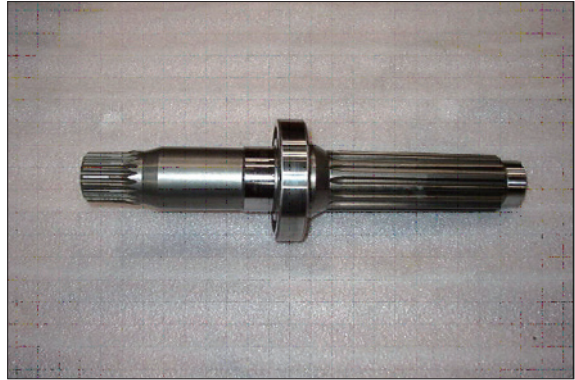

21078TM46

- 3) Using a jig, assemble shaft assembly into shaft casing (1).



21078TM47

- 4) After spreading grease on steel ball (8) assemble into shaft casing (1).



21078TM48

- 5) Assemble swash piston assembly (4, 5) into shaft casing (1).



21078TM49

- 6) Assemble swash plate (9) into shaft casing (1).

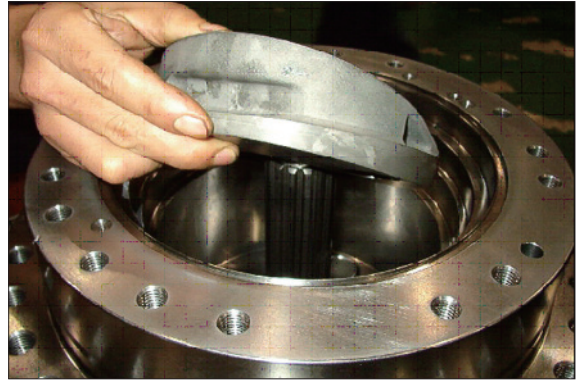

21078TM50

■ Assemble cylinder block sub.

- 7) Assemble spring seat (13), spring (12), spring seat (11) into cylinder block (10) respectively, pushing spring (12) using by a jig, assemble snap ring (14) with a snap ring (14).



21078TM51

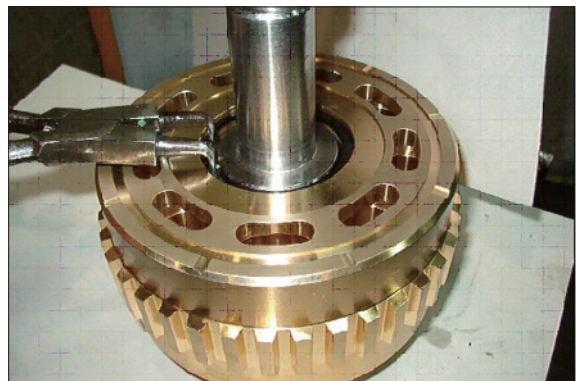

21078TM52

8) Assemble ring, pin (15) on cylinder block (10) ball guide (16) respectively.

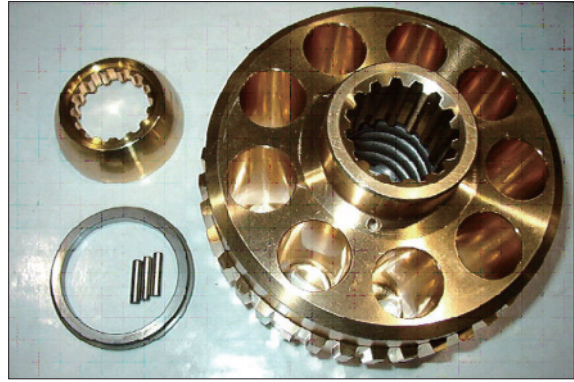

21078TM53

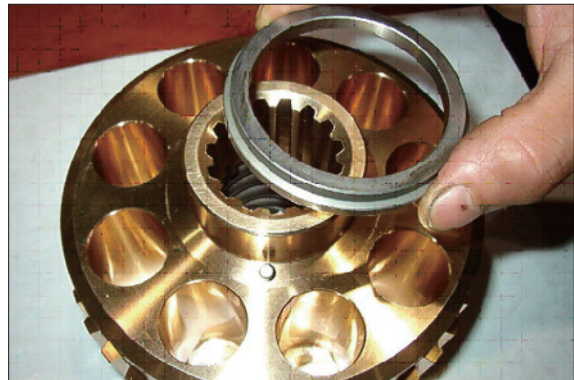

21078TM54

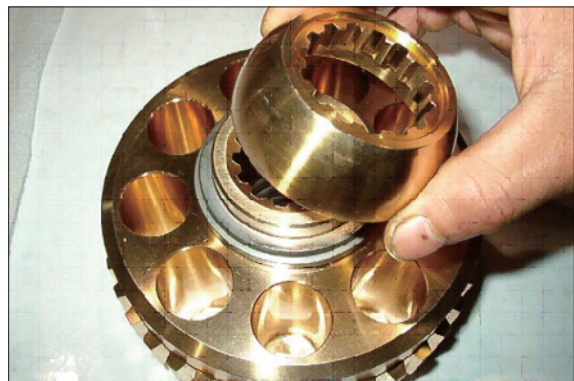

21078TM55

9) Assemble cylinder block assembly, piston assembly (9), seat plate (17).



21078TM56

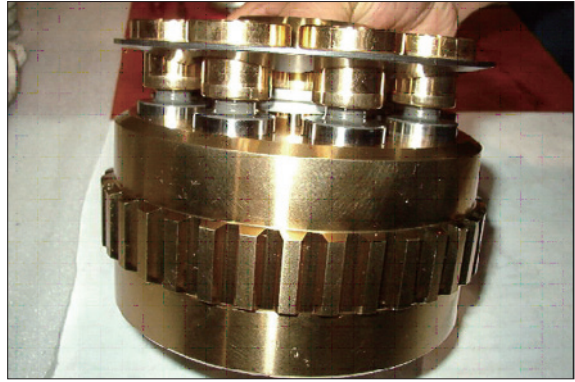

21078TM57

10) Assemble cylinder block assembly (9) into shaft casing (1).

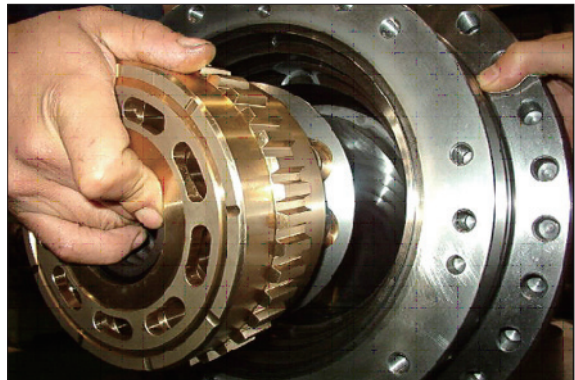

21078TM58

11) Assemble friction plate (19) and plate (20) into shaft casing (1) respectively, prepare 6 set.

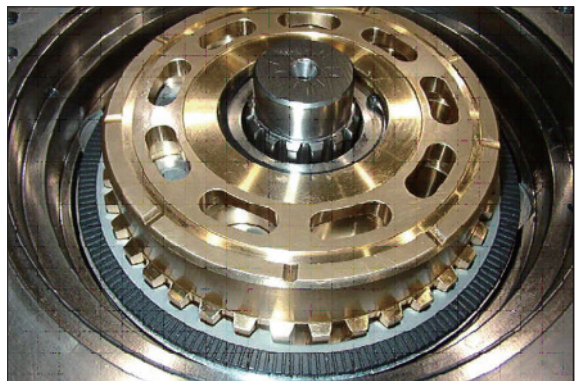

21078TM59

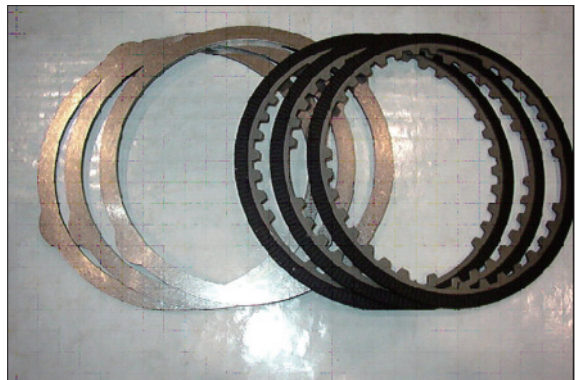

21078TM59-1

12) Assemble O-ring (22, 23) into packing piston (21).

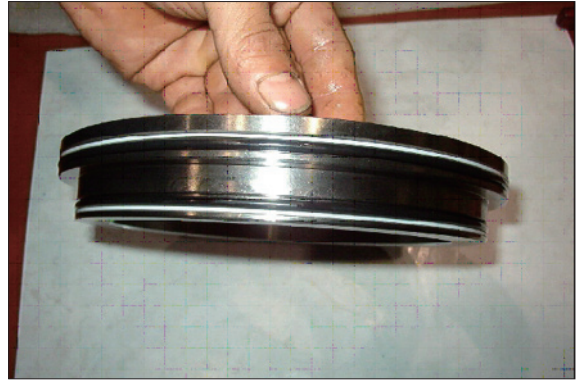

21078TM60

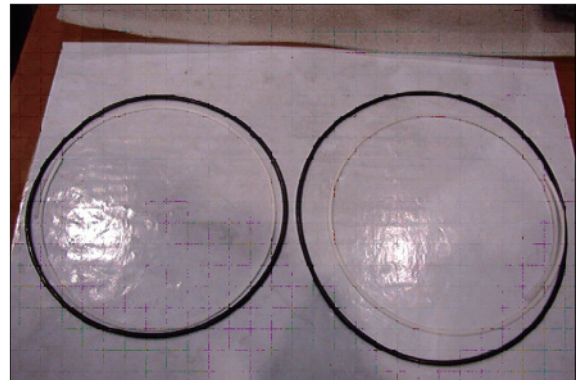

21078TM60-1

13) After spreading grease on packing piston (21) bond wrench bolt and assemble shaft casing (1).

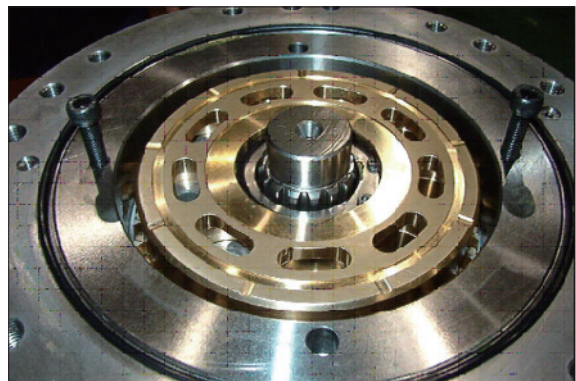

21078TM61

■ Assemble rear cover sub.

14) Using a jig, assemble bearing (69) into rear cover (29).

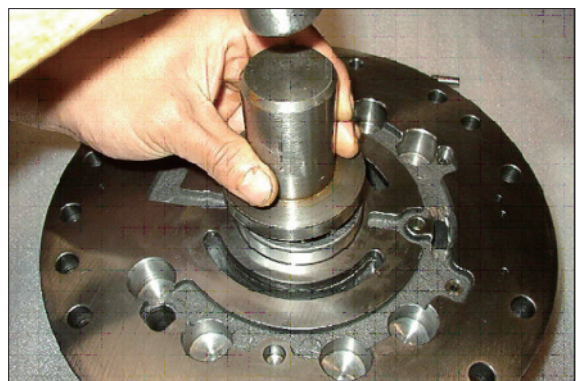

21078TM62

- 15) After assembling spool (59), spool (47), O-ring (51), guide (48) and snap ring (53) respectively into rear cover (29).
Using torque wrench, assemble it.



21078TM63

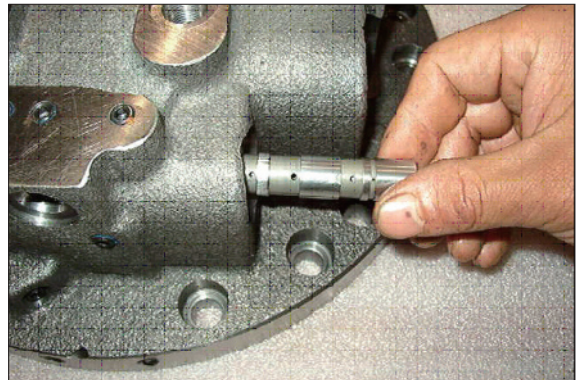

21078TM64

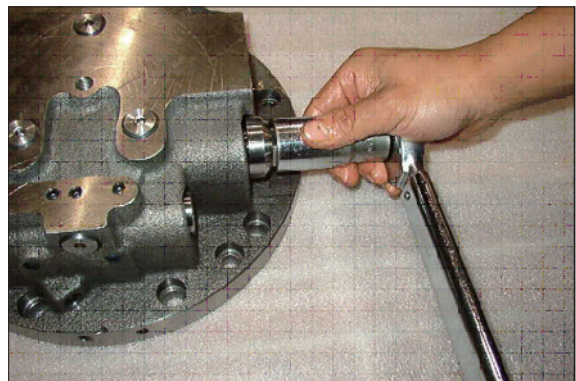

21078TM65

16) Assemble spring seat (35), spring (36), spring seat (43), spool (39), spring (38), cover (37) respectively and assemble wrench bolt (45).
(Same balance on both sides)

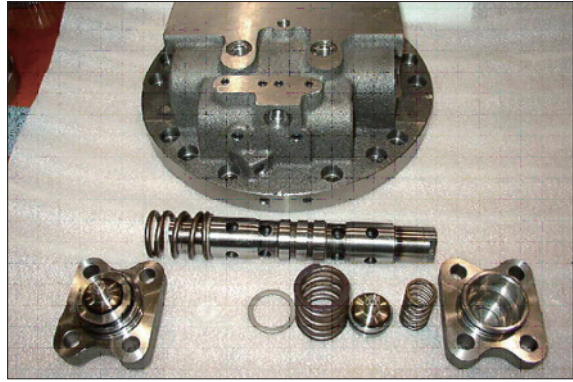

21078TM66

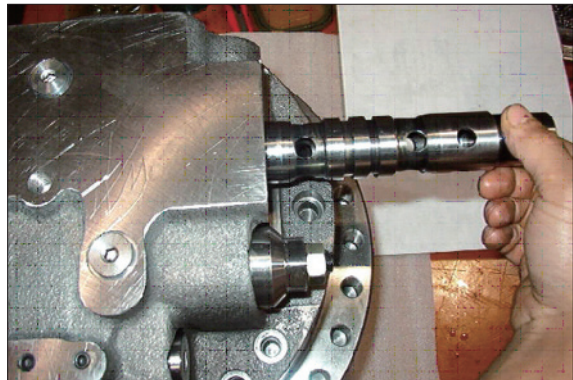

21078TM67

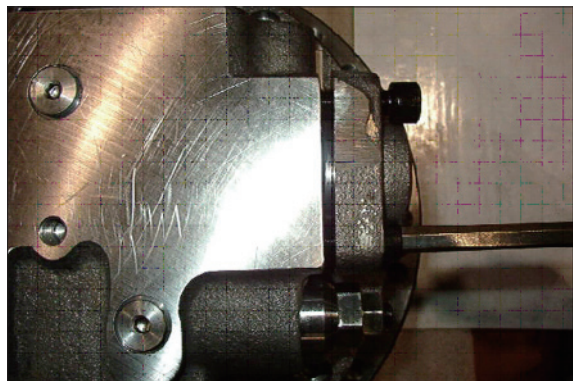

21078TM67-1

17) Assemble plug (2).

※ Plug (NPT1/16) - 11EA

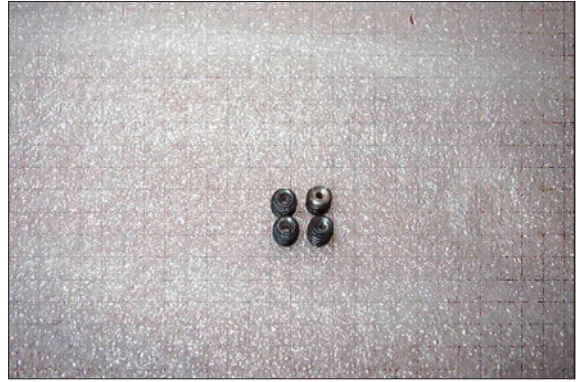

21078TM68



21078TM69

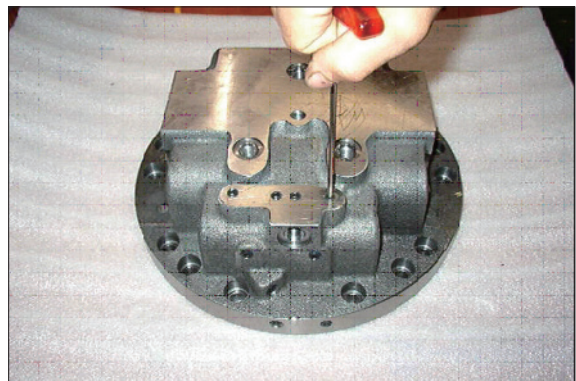

21078TM70

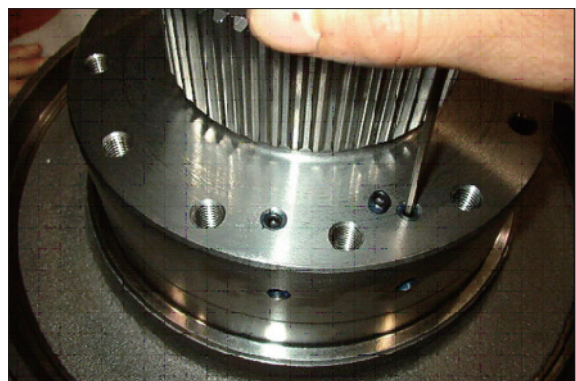

21078TM71

18) Assemble plug (64).

※ Plug (PT3/8) - 11EA

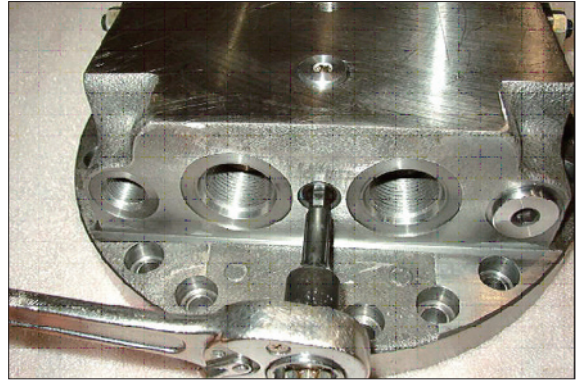

21078TM72

19) Assemble plug (62, 63) into rear cover (29) and assemble relief valve assembly.

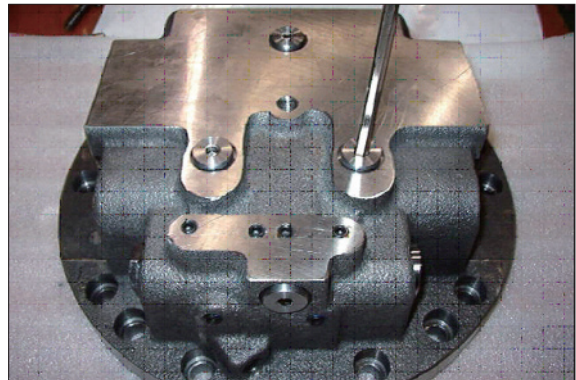

21078TM73

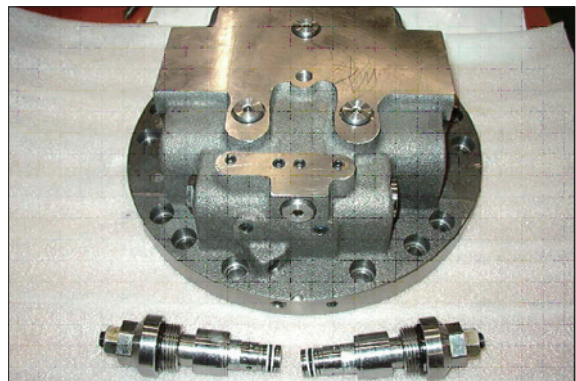

21078TM74

20) Put spring (67, 68) together into rear cover (29), prepare 6 set.

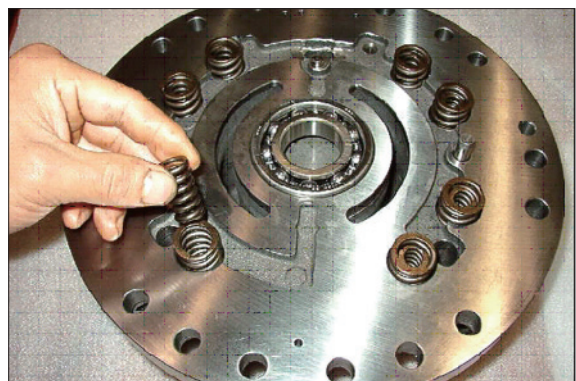

21078TM75



21078TM76

21) Assemble valve plate (70) into rear cover (29).

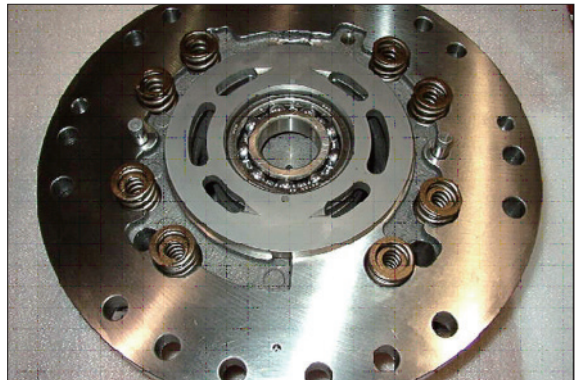

21078TM77

22) After assembling shaft casing (1) and rear cover (29).
Assemble spool assembly (30), spring (38),
spool (39), cover (37) after then complete
assembly with wrench bolt (45).

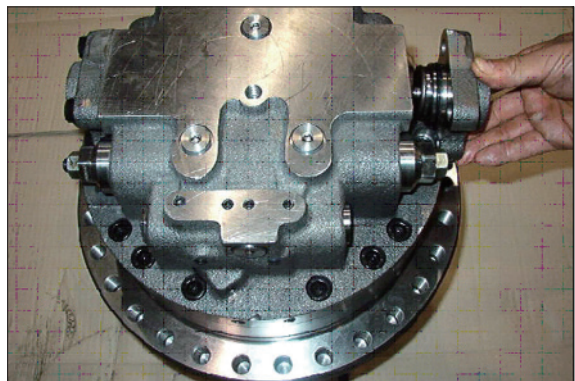

21078TM78

23) Finish assembly.

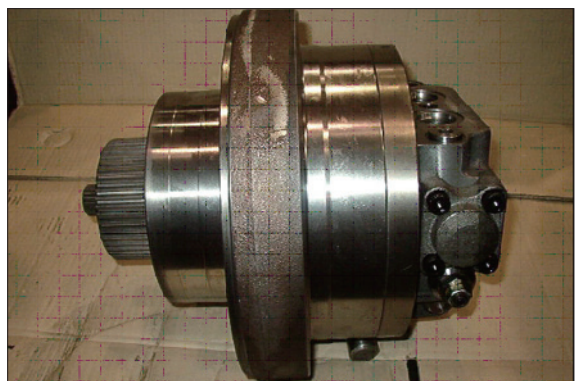

21078TM79

5.1 DISASSEMBLING REDUCTION UNIT

1) Preparation for disassembling

- (1) The reduction units removed from excavator are usually covered with mud. Wash outside of propelling unit and dry it.
- (2) Locate reducer in order for drain port to be at the lowest level loosen taper screw plug of drain port, and drain oil from reduction gear.
 - ※ While oil is still hot, inside of the unit may be pressurized.

▲ Take care of the hot oil gushing out of the unit when loosening the plug.

(3) Mark for mating

Put marks on each mating parts when disassembling so as to reassemble correctly as before.

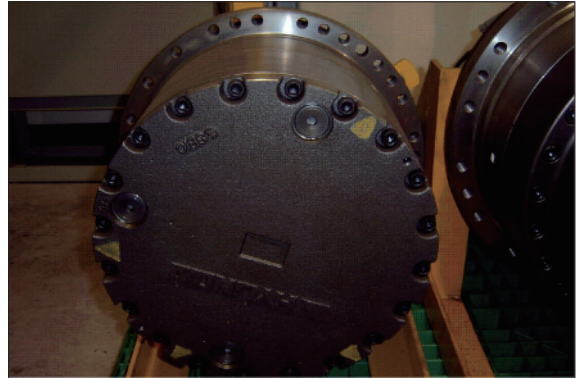

21078TM80

2) Setting reduction unit (or whole propelling unit) on work stand for disassembling

- (1) Remove M12 hexagon socket head bolts (95) at 3 places from cover (93) almost equally apart each other, and then install M12 × 155L eye bolts. Lift up the unit using them and place it on work stand with cover upward.

▲ Take great care not to pinch your hand between parts while disassembling nor let fall parts on your foot while lifting them.



21078TM81

3) Removing cover

- (1) Remove the rest of M12 hexagon socket head bolts (95) that securing gear and housing. Loosen all the socket bolts and then, disassemble cover.
- (2) As the cover (93) is adhered to ring gear (88), disassemble ring gear (88) and cover (93) by lightly hammering slantwise upward using sharpened punch inserted between the cover and ring gear.

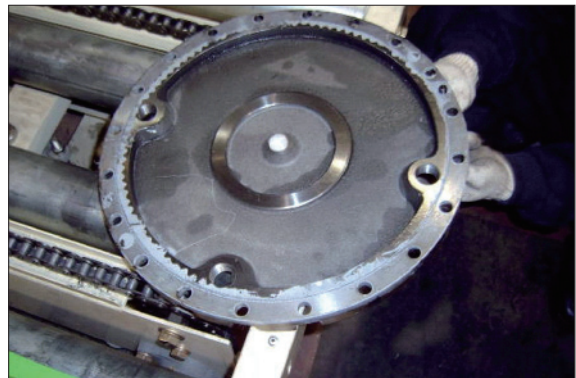

21078TM82

4) Removing No.1 carrier sub assembly

- (1) Screw three M10 eye-bolt in No.1 carrier and lift up and remove No.1 carrier assy.

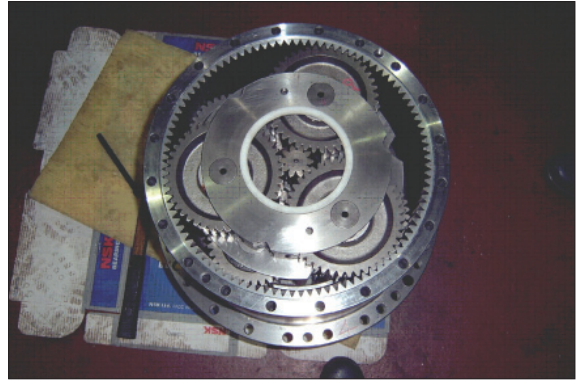

21078TM83

- (2) Remove No.1 sun gear

- ※ Be sure to maintain it vertical with the ground when disassembling No.1 sun gear.

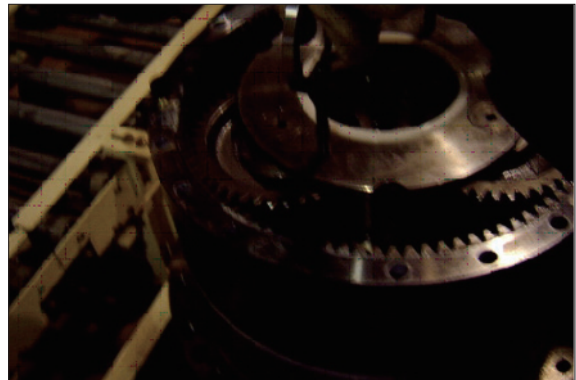

21078TM84

5) Removing No.2 carrier sub assembly

- (1) Screw three M10 eye-bolt in No.2 carrier and lift up and remove No.2 carrier assy.



21078TM85

- (2) Remove No.2 sun gear

- ※ Be sure to maintain it vertical with the ground when disassembling No.2 sun gear.



21078TM86

6) Removing ring gear

- (1) As the ring gear (88) is adhered to housing (81), disassemble ring gear (88) and housing (81) by lightly hammering slantwise upward using sharpen punch inserted between the ring gear and housing.
 - ※ Carefully disassembling ring gear not to make scratch on it.
- (2) Screw M14 eye-bolt in ring gear and lift up and remove it.

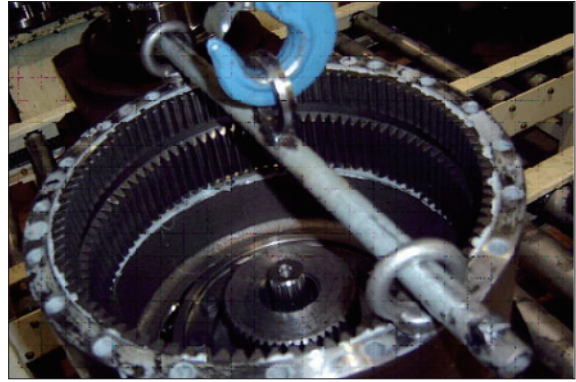

21078TM87

7) Removing coupling

- (1) Remove coupling.

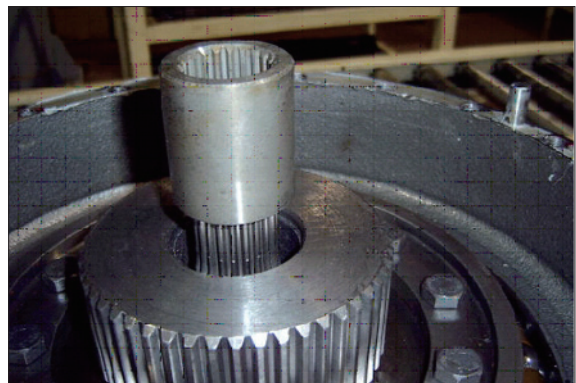

21078TM88

8) Removing retainer & shim

- (1) Remove M12 hexagon socket head bolts that secure retainer and motor.
- (2) Remove retainer & shim.

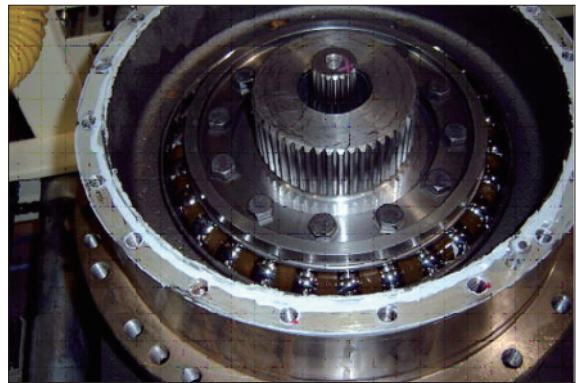

21078TM89

9) Removing housing sub assembly

- (1) Screw M12 eye bolt in housing and lift up housing assembly including angular bearing and floating seal.



21078TM90

10) Removing floating seal

- (1) Lift up a piece of floating seal of motor side.

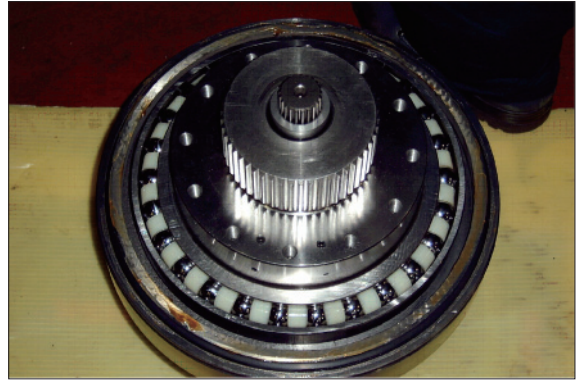

21078TM91

11) Disassembling housing assembly

- (1) After turning housing, lift up a piece of floating seal from housing and then remove it.
- ※ Don't disassemble angular bearing.

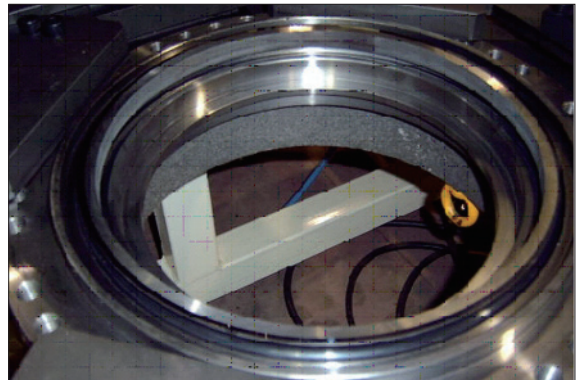

21078TM92

12) Disassembling No.1 carrier

- (1) Remove thrust ring (90-7) from carrier.
- (2) Knock spring pin (91-8) fully into No.1 pin (91-7).
- (3) Remove planetary, thrust washer, No.1 pin, bearing from carrier.

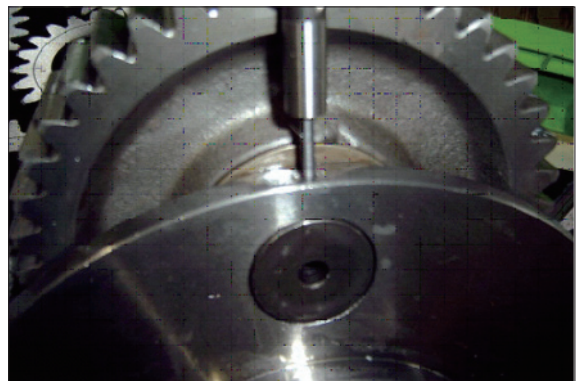

21078TM93



21078TM94



21078TM95

13) Disassembling No.2 carrier

- (1) Disassemble No.2 carriers, using the same method for No.1 carrier assembly.



21078TM96



21078TM97

6.1 ASSEMBLY REDUCTION GEAR

■ General notes

Clean every part by kerosene and dry them by air blow.

Surfaces to be applied by locktite must be decreased by solvent.

Check every part for any abnormalities.

Each hexagon socket head bolt should be used with locktite No.

262 applied on its threads.

Apply gear oil slightly on each part before assembling.

Take great care not to pinch your hand between parts or tools while assembling nor let fall parts on your foot while lifting them.

Inspection before reassembling

Thrust washer

- Check if there are seizure, abnormal wear or uneven wear.
- Check if wear is over the allowable limit.

Gears

- Check if there are pitting or seizure on the tooth surface.
- Check if there are cracks on the root of tooth by die check.

Bearings

- Rotate by hand to see if there are something unusual such as noise or uneven rotation.

Floating seal

- Check flaw or score on sliding surfaces or O-ring.

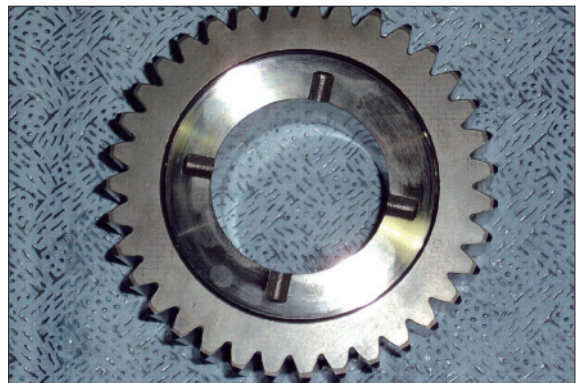

21078TM98

1) Assembling No.1 carrier

- (1) Put No.1 carrier (91-1) on a flat place.
- (2) Install No.1 needle bearing (91-5) into No.1 planetary gear (91-4), put 2EA of No.1 thrust washer (91-6) on both sides of bearing, and then, install it into carrier.

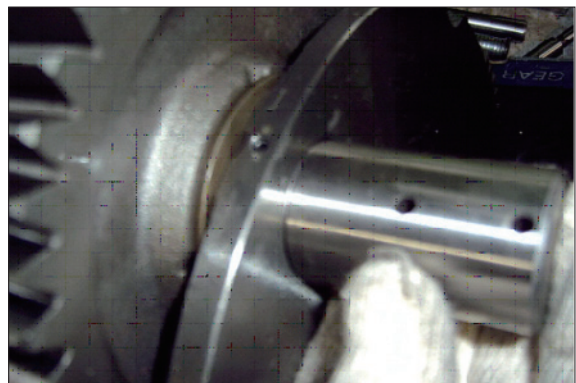

21078TM99

- (3) Install No.1 pin (91-5) into No.1 carrier where the holes for No.1 pin (91-5) are to be in line with those of No.1 carrier, and then, install spring pins into the holes.

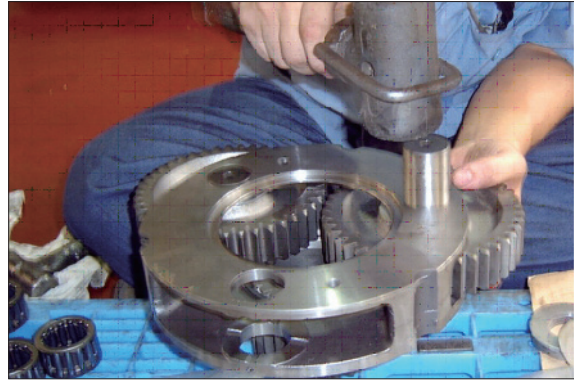

21078TM100

- (4) Caulk carrier holes as shown on the picture.
 (5) Assemble thrust ring (90-7) into carrier.

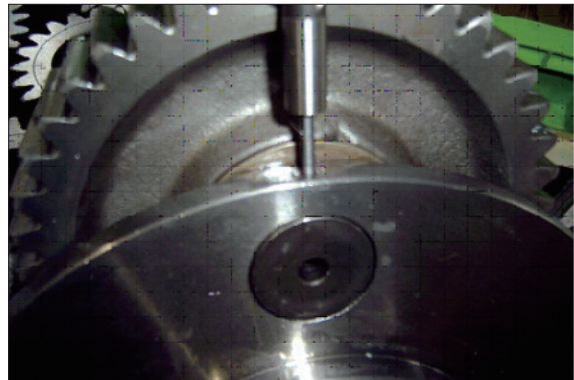

21078TM101

2) Assembling No.2 carrier

- (1) Put No.2 carrier (90-1) on a flat place.
 (2) Install No.2 needle bearing (90-3) into No.2 planetary gear (90-2), put 2EA of No.2 thrust washer (90-4) on both sides of bearing, and then, install it into carrier.

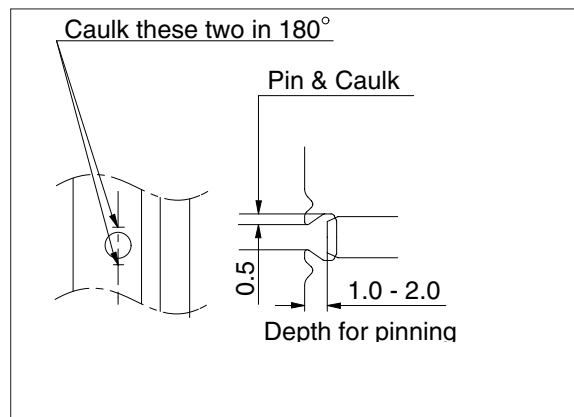

21078TM102

- (3) Install No.2 pin (90-5) into No.2 carrier where the holes for No.2 pin (90-5) are to be in line with those of No.2 carrier, and then, install spring pins into the holes.



21078TM103

- (4) Caulk carrier holes as shown on the picture.
- (5) Assemble thrust ring(90-7) into carrier.

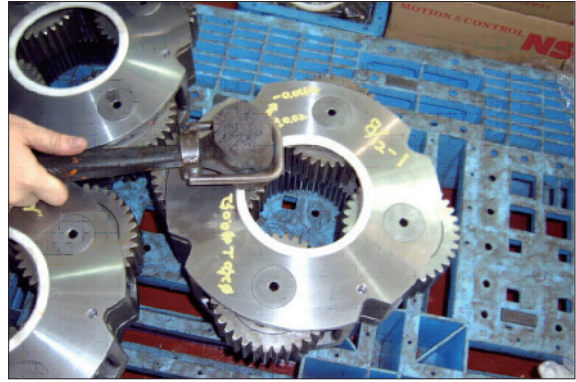

21078TM104

3) Assembling floating seal (83) and main bearing (82)

- (1) Assemble floating seal into motor by use of pressing jig. Grease the contact parts for floating seal which is assembled into motor.
- (2) Heat bearing at 60~70°C and then, put into the motor side.

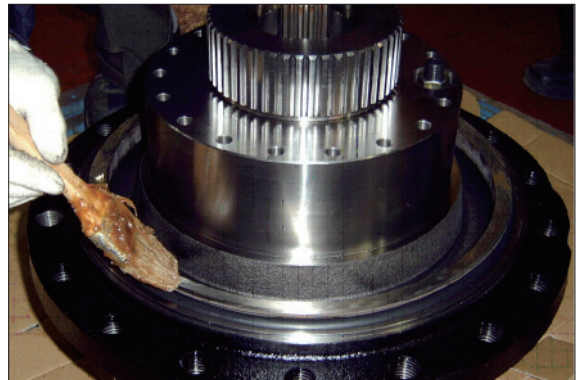

21078TM105

- ※ Be sure to maintain it vertical with the ground when assembling bearing and floating seal.



21078TM106

4) Assembling housing

- (1) Heat housing at 60~70°C while clearing it out and then, assemble floating seal into housing by use of pressing jig.
- ※ Be sure to maintain it vertical with the ground when assembling floating seal.

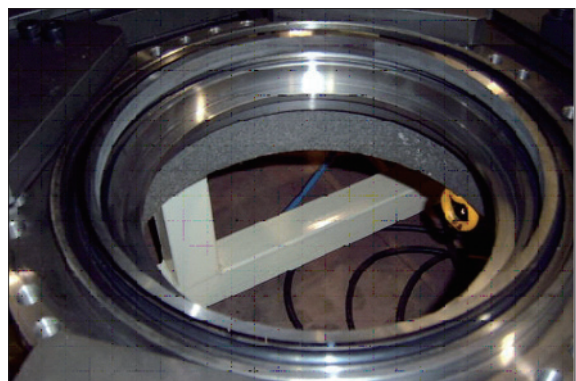

21078TM705

5) Installing housing assembly

- (1) Install 2EA of M12 eye-bolt into housing assembly.
 - (2) Assemble housing into motor by use of hoist and eye-bolt.
- ※ Be sure to tighten eye-bolt deep enough.

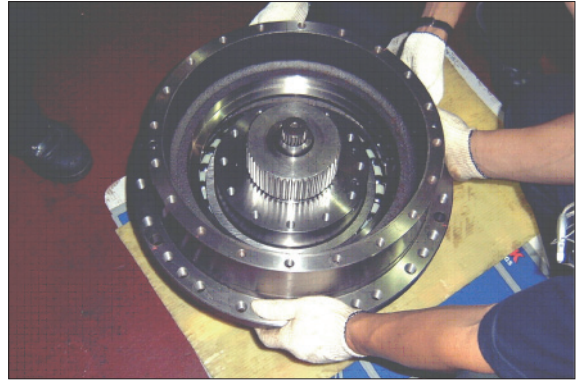

21078TM108

6) Installing main bearing (82)

- (1) Heat main bearing at 60~70° C and then, install.
- ※ Be sure to maintain it vertical with the ground when assembling bearing.

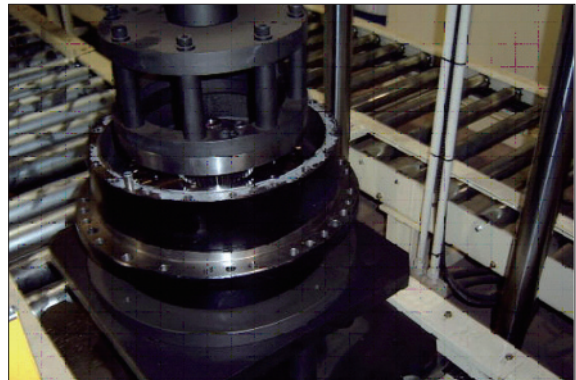

21078TM109

7) Installing retainer (85) and shim (84)

- (1) Measure clearance between main bearing and retainer by use of jig to decide the thickness of shim and select an appropriate shim, and then, assemble retainer.
- (2) Apply locktite (#262) on M12 hexagon head bolt, and then, bolt.

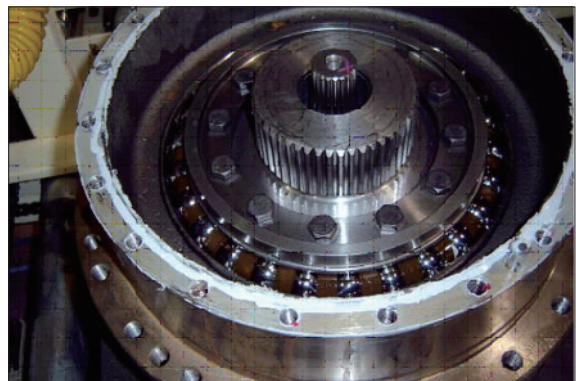

21078TM110

8) Installing coupling

- (1) Install coupling on spline of the motor.

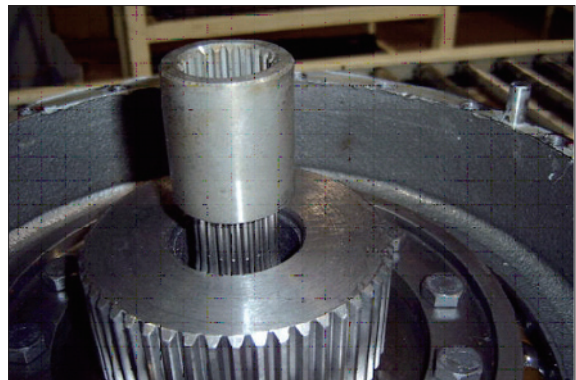

21078TM111

9) Installing ring gear

- (1) Apply three bond #1104 (loctite #515) on housing for ring gear without gap.
- (2) Insert lock pin into housing hole.
- (3) Install M14 eye-bolt on the tap of ring gear.
- (4) Lift ring gear and then, assemble into housing in order for hole of ring gear and parallel pin of housing to be in line.
- (5) Temporarily secure 4EA of M12 hexagon socket bolt and shim with cover thickness having appropriate torque.

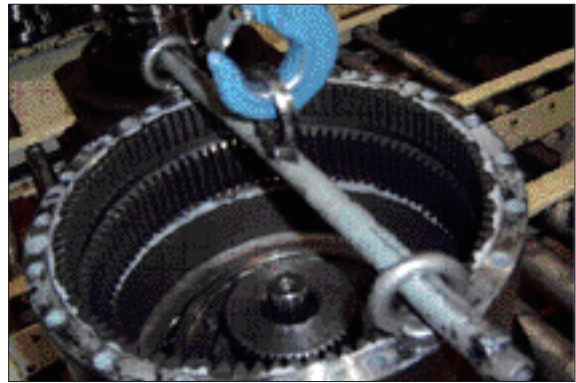
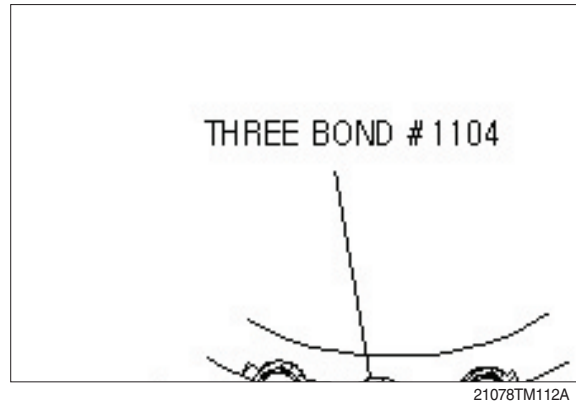

10) Installing No.2 carrier sub assembly

- (1) Install M10 eye-bolt on No.2 carrier assembly.
- (2) Lift No.2 carrier assembly and then, slowly put it down on ring gear.
- (3) Rotate planetary gear by hands and install on ring gear.



11) Installing No.2 sun gear (91-2)

- (1) Install No.2 sun gear on the spline of No.2 carrier and No.2 planetary gear, matching teeth of them.



21078TM115

- (2) Install No.2 sun gear on the spline of No.2 carrier and No.2 planetary gear, matching teeth of them.

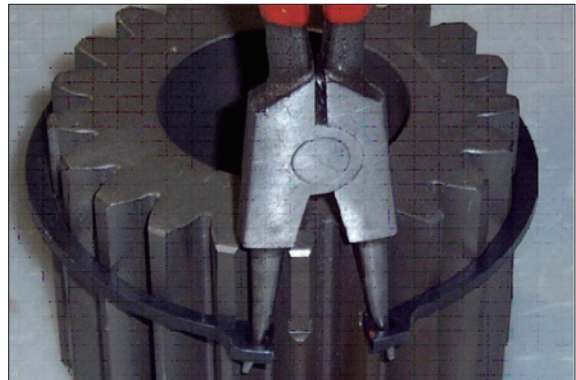

21078TM116

12) Installing No.1 carrier sub assembly

- (1) Install M10 eye-bolt on No.2 carrier assembly.
- (2) Lift No.1 carrier assembly and then, slowly put it down on ring gear.
- (3) Rotate planetary gear by hands and install on ring gear.



21078TM117

13) Installing No.1 sun gear (92)

- (1) Put down No.1 sun gear on No.1 carrier, maintaining it vertical with spline of coupling.
- (2) Install No.1 sun gear on No.1 planetary gear, matching their teeth.

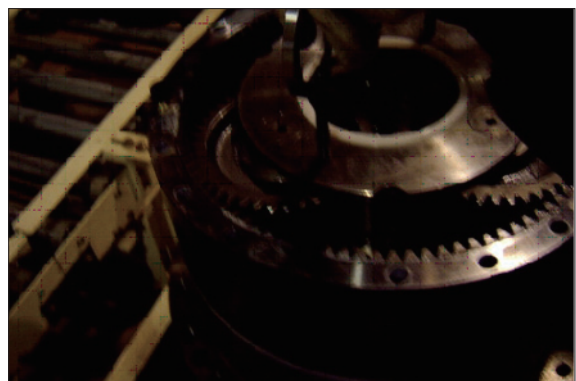

21078TM118

14) Installing cover (93)

- (1) Beat pad (94) with plastic hammer, and press it into the center of cover.
- (2) Apply three bond #1104, loctite (#515) on the ring gear for cover without gap.
- (3) Put cover on ring gear, apply loctite (#262) on M12 hexagon socket head bolt, and then, bolt.

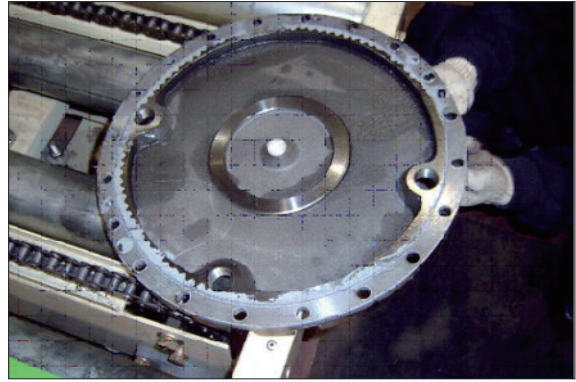

21078TM119

- (4) Fill gear oil (5.8 liter) into drain port.
- (5) Apply gear oil on PF3/4 hydraulic plug (97) and then, bolt.

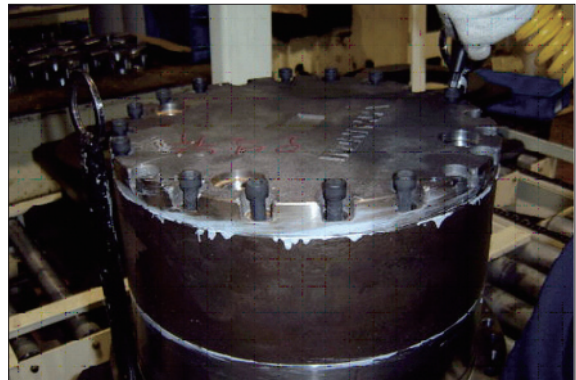

21078TM120