

GROUP 13 EPPR VALVE

1. PUMP EPPR VALVE

1) COMPOSITION

EPPR (Electro Proportional Pressure Reducing) valve consists of electro magnet and spool valve installed at main pump.

(1) Electro magnet valve

Receive electric current from MCU and move the spool proportionally according to the specific amount of electric current value.

(2) Spool valve

Is the two way direction control valve for pilot pressure to reduce main pump flow.

When the electro magnet valve is activated, pilot pressure enters into flow regulator of main pump.

(3) Pressure and electric current value for each mode

Mode		Pressure		Electric current (mA)	Engine rpm (at accel dial 10)
		kgf/cm ²	psi		
Standard (Stage : 1.0)	P	4	57	230 ± 30	2100 ± 50
	S	10 ± 3	142 ± 40	330 ± 30	1900 ± 50
	E	15 ± 3	213 ± 40	400 ± 30	1750 ± 50
Option (Stage : 2.0)	P	0	0	160 ± 30	2100 ± 50
	S	10 ± 3	142 ± 40	330 ± 30	1900 ± 50
	E	15 ± 3	213 ± 40	400 ± 30	1750 ± 50

2) HOW TO SWITCH THE STAGE (1.0 ↔ 2.0) ON THE CLUSTER

You can switch the EPPR valve pressure set by selecting the stage (1.0 ↔ 2.0).

- Management
 - Service menu

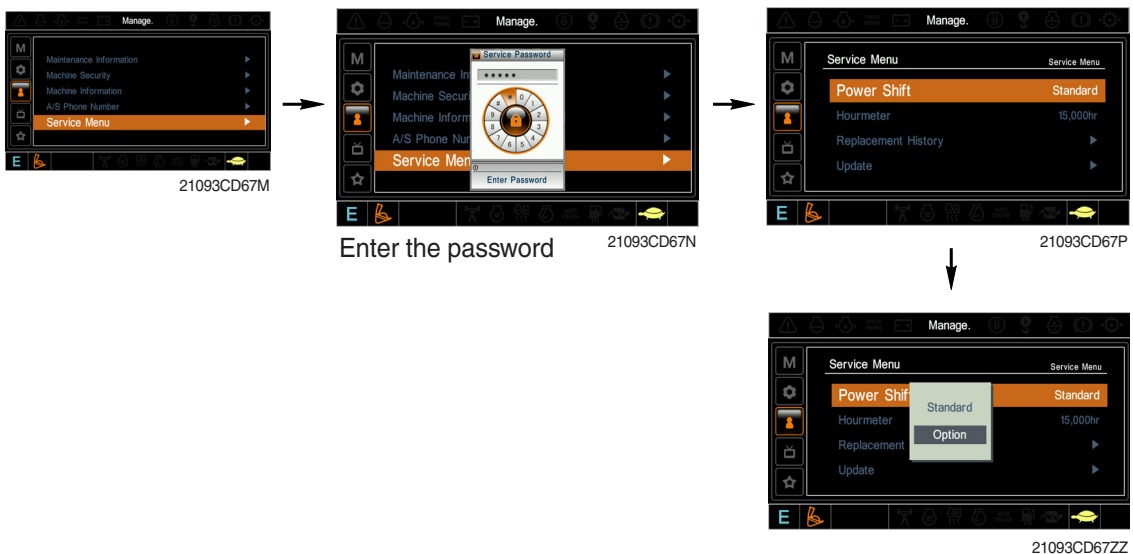

- Power shift (standard/option) : Power shift pressure can be set by option menu.

3) OPERATING PRINCIPLE (pump EPPR valve)

(1) Structure

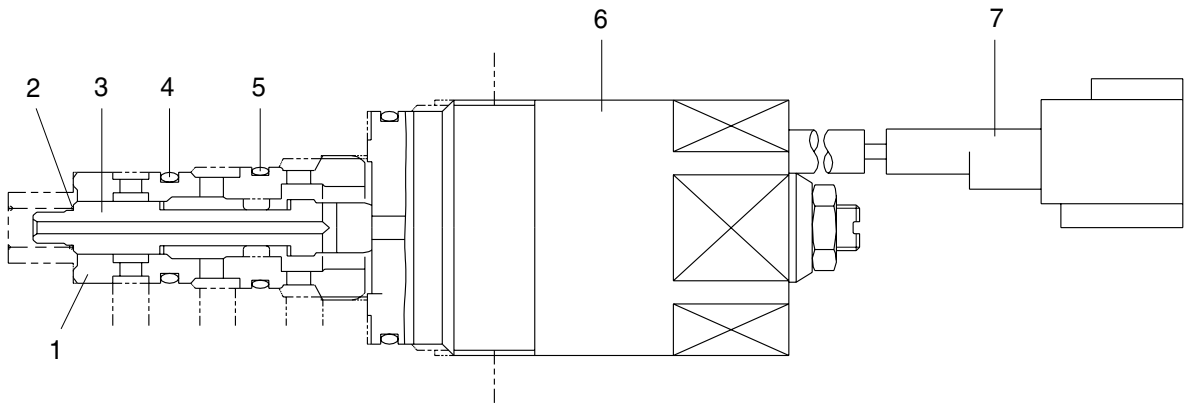

5-22(1)

- 1 Sleeve
- 2 Spring
- 3 Spool

- 4 O-ring
- 5 O-ring

- 6 Solenoid valve
- 7 Connector

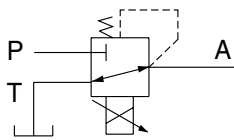

P Pilot oil supply line (pilot pressure)

T Return to tank

A Secondary pressure to flow regulator at main pump

(2) Neutral

Pressure line is blocked and A oil returns to tank.

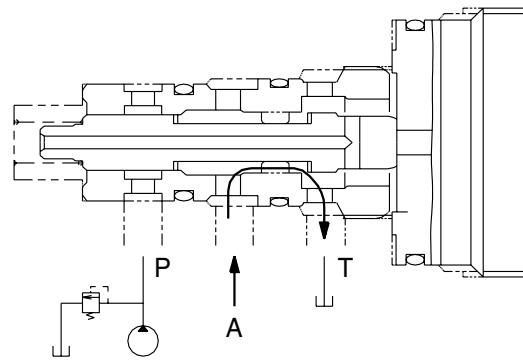
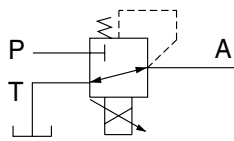

(3) Operating

Secondary pressure enters into A.

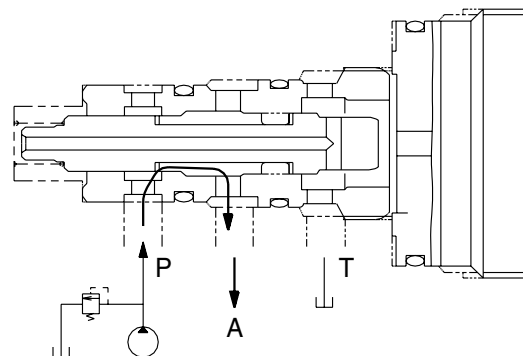
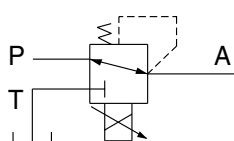

5-22(2)

4) EPPR VALVE CHECK PROCEDURE

(1) Check electric current value at EPPR valve

- ① Disconnect connector CN-75 from EPPR valve.
- ② Insert the adapter to CN-75 and install multimeter as figure.
- ③ Start engine.
- ④ Set S-mode and cancel auto decel mode.
- ⑤ Position the accel dial at 10.
- ⑥ If rpm display show approx 1900 ± 50 rpm check electric current at bucket circuit relief position.

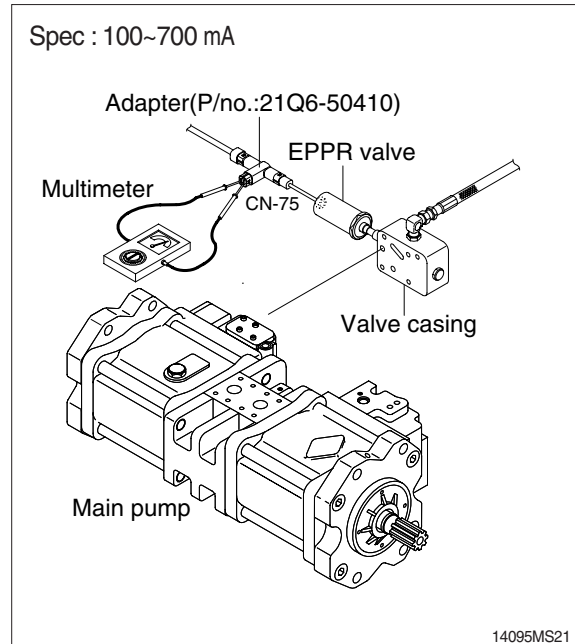

(2) Check pressure at EPPR valve

- ① Remove plug and connect pressure gauge as figure.
 - Gauge capacity : 0 to 50 kgf/cm² (0 to 725 psi)
- ② Start engine.
- ③ Set S-mode and cancel auto decel mode.
- ④ Position the accel dial at 10.
- ⑤ If rpm display approx 1900 ± 50 rpm check pressure at relief position of bucket circuit by operating bucket control lever.
- ⑥ If pressure is not correct, adjust it.
- ⑦ After adjust, test the machine.

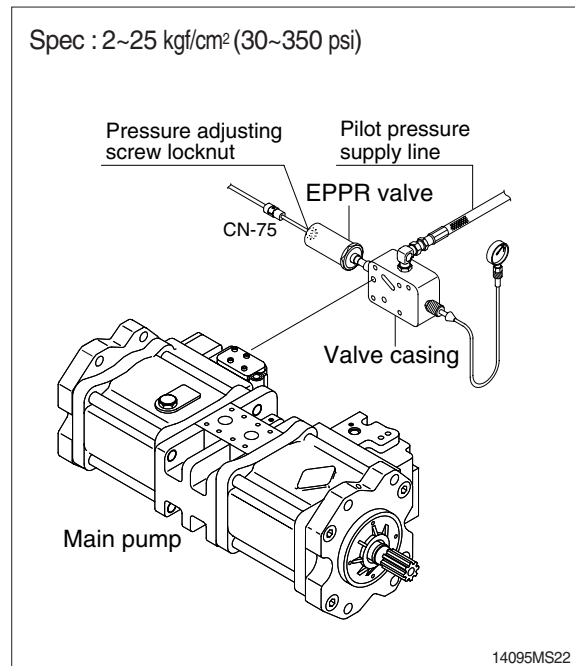

2. BOOM PRIORITY EPPR VALVE

1) COMPOSITION

The boom priority EPPR valve is built in a manifold and mainly consisting of valve body and coil. This EPPR valve installed under the solenoid valve.

2) CONTROL

The boom priority EPPR valve has to be controlled by a specific electronic amplifier card, which is supplying the coil with a current 580 mA at 30 Ω and 24 V.

3) OPERATING PRINCIPLE

(1) Structure

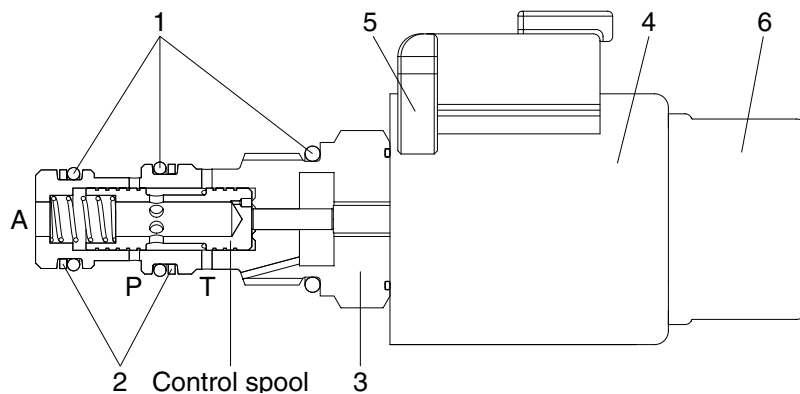

21095MS14

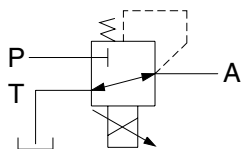

P : Pilot supply line
T : Return to tank
A : Secondary pressure to flow MCV

- | | | | | | |
|---|--------------|---|------------|---|-----------|
| 1 | O-ring | 3 | Valve body | 5 | Connector |
| 2 | Support ring | 4 | Coil | 6 | Cover cap |

(2) Operation

In de-energized mode the inlet port (P) is closed and the outlet port (A) is connected to tank port (T).

In energized mode the solenoid armature presses onto the control spool with a force corresponding to the amount of current. This will set a reduced pressure at port A. The setting is proportional to the amount of current applied.

(3) Maximum pressure relief

If a pressure from outside is applied on port A the valve may directly switch to tank port (T) and protect the system before overload.

2) EPPR VALVE CHECK PROCEDURE

(1) Check electric current value at EPPR valve

- ① Disconnect connector CN-133 from EPPR valve.
- ② Insert the adapter to CN-133 and install multimeter as figure.
- ③ Start engine.
- ④ If rpm display approx 1900 ± 50 rpm check electric current in case of combined boom up and swing operation.

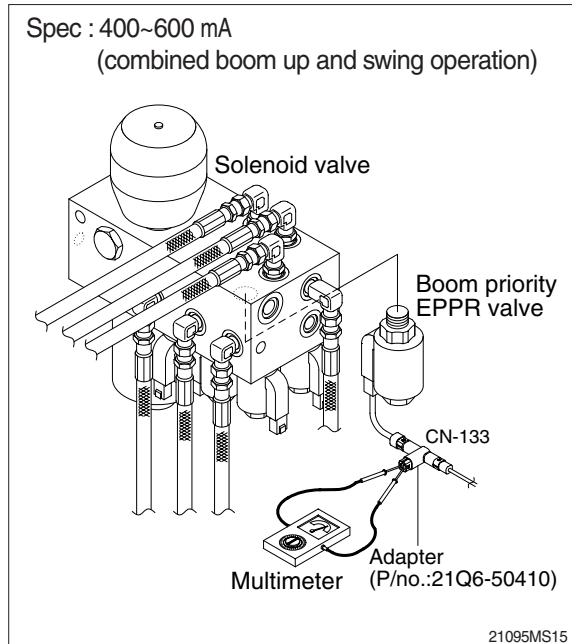

(2) Check pressure at EPPR valve

- ① Remove hose from A5 port and connect pressure gauge as figure.
 - Gauge capacity : 0 to 50 kgf/cm²
(0 to 725 psi)
- ② Start engine.
- ③ If rpm display approx 1900 ± 50 rpm check pressure at relief position of bucket circuit by operating bucket control lever.
- ④ If pressure is not correct, adjust it.
- ⑤ After adjust, test the machine.

