

GROUP 2 MAJOR COMPONENT

1. MAIN PUMP

Before inspection, wash the parts well and dry them completely.

Inspect the principal parts with care and replace them with new parts when any abnormal wear exceeding the allowable limit or damage considered harmful is found.

Replace the seal also when any remarkable deformation and damage are found.

1) INSPECTION POINTS WHEN DISASSEMBLED

Part	Extent of the damage	Inspection standard	Action
Shaft (3)	Excessive wear on the seal surface.	Worn depth : 0.025 mm or more	Replace the shaft.
Valve plate (5)	Excessive wear or damages on the sliding surface.	Worn depth : 0.020 mm or more	Replace the cylinder barrel kit.
Cylinder barrel (4)	Excessive wear or damages on the sliding surface.	Worn depth : 0.020 mm or more	Replace the cylinder barrel kit.
	Clearance between the pistons.	0.050 mm or more	Replace the cylinder barrel kit.
Piston (6), Shoe (7)	Wear of joint section	Play between the shoe and the piston. 0.2 mm or more by hand operation.	Replace the cylinder barrel kit.
Seals (O-rings, gasket, etc.)	Damage, excessive rust	-	Replace each part.

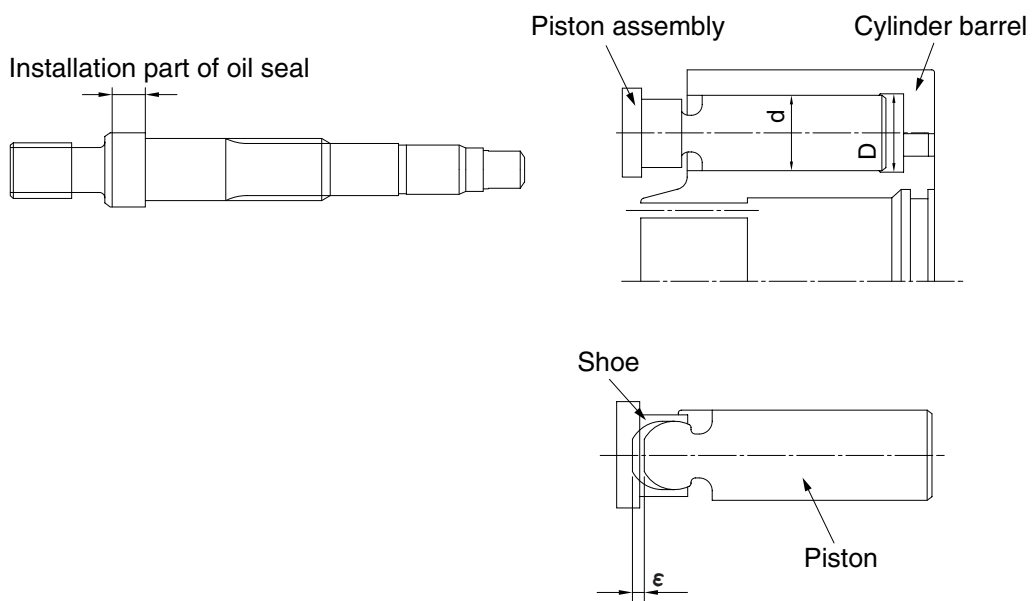

R27Z96MC01

2) TROUBLESHOOTING AND COUNTERMEASURE

No.	Trouble	Possible cause	Countermeasure
1	Overload to engine	<ul style="list-style-type: none"> · Speed is higher than standard · Setting pressure is higher than specifications · Damage of internal parts of pump 	<ul style="list-style-type: none"> · Readjust it as standard · Readjust it as spec · Repair or replace
2	Low pump flow or low pressure	<ul style="list-style-type: none"> · Speed down of engine · Wrong coupling · Damage of internal parts of pump 	<ul style="list-style-type: none"> · Readjust of engine speed · Repair or replace · Repair or replace
3	Abnormal noise or abnormal vibration (cavitations)	<ul style="list-style-type: none"> · Air in the oil · Water in the oil · Clog of suction filter · High suction pressure · Damage of piston shoe · Installation condition is no good · Wrong coupling 	<ul style="list-style-type: none"> · Check piping Bleed the air in the hydraulic circuit · Replace oil · Clean or replace · Correction · Replace · Correction · Replace
4	Oil leakage	<ul style="list-style-type: none"> · Damage of O-ring or packing · Loosened plug · Leaking from oil seal 	<ul style="list-style-type: none"> · Replace · Tight up · Replace Replace of oil seal

2. MAIN CONTROL VALVE

Part name	Inspection item	Criteria & measure
Block	<ul style="list-style-type: none"> · Existence of scratch, rusting or corrosion. 	<ul style="list-style-type: none"> · In case of damage in following section, replace part. - Sliding sections of casing fore and spool, especially land sections applied with holded pressure. - Seal pocket section where spool is inserted. - Seal section of port where O-ring contacts. - Seal section of each relief valve for main, travel, and port. - Other damages that may damage normal functions.
Spool	<ul style="list-style-type: none"> · Existence of scratch, gnawing, rusting or corrosion. · O-ring seal sections at both ends. · Insert spool in casing hole, rotate and reciprocate it. 	<ul style="list-style-type: none"> · Replacement when its outside sliding section has scratch (Especially on seals-contacting section). · Replacement when its sliding section has scratch. · Correction or replacement when O-ring is damaged or when spool does not move smoothly.
Poppet	<ul style="list-style-type: none"> · Damage of poppet or spring · Insert poppet into casing and function it. 	<ul style="list-style-type: none"> · Correction or replacement when sealing is incomplete. · Normal when it can function lightly without being caught.
Around spring	<ul style="list-style-type: none"> · Rusting, corrosion, deformation or breaking of spring, spring seat, plug or cover. 	<ul style="list-style-type: none"> · Replacement for significant damage.
Around seal for spool	<ul style="list-style-type: none"> · External oil leakage. · Rusting, corrosion or deformation of seal plate. 	<ul style="list-style-type: none"> · Correction or replacement. · Correction or replacement.
Main relief valve, port relief valve & Anti cavitation valve	<ul style="list-style-type: none"> · External rusting or damage. · Contacting face of valve seat. · Contacting face of poppet. · Abnormal spring. · O-rings, back up rings and seals. 	<ul style="list-style-type: none"> · Replacement. · Replacement when damaged. · Replacement when damaged. · Replacement. · 100% replacement in general.



3. SWING MOTOR

1) POSSIBLE REASONS FOR THE TROUBLE AND ITS COUNTERMEASURES

Trouble	Possible reasons		Countermeasure
Motor does not move. The supplied pressure is enough.	Relief valve	Setting pressure is too low.	Replace the relief valve assembly.
		Faulty operation.	
	Hydraulic motor	Burned inner parts.	Replace the hydraulic motor assembly.
		Too much internal leakage.	
	Reduction gear	Damage to the gears.	Replace the reduction gear assembly.
Overload	-	Remove the overload.	
Insufficient torque	Relief valve	Setting pressure is too low.	Replace the relief valve assembly.
		Faulty operation.	
	Hydraulic motor	Burned sliding parts.	Replace the hydraulic motor assembly.
		Too much internal leakage.	
	Reduction gear	Damage to the gears.	Replace the pinion kit, carrier kit.
Damage to bearings.			
Abnormal noise	Cavitation noise	Insufficient flow.	Adjust the piping.
	Hydraulic motor	Damage to sliding parts.	Replace the hydraulic motor assembly.
		Damage to the gears.	
	Reduction gear	Damage to bearings	Replace the pinion kit, carrier kit.
Pinion gear	Damage to the gear surface.	Replace the pinion kit.	
Oil leakage	Body gasket	Damage to O-rings.	Replace the O-ring
		Loose bolts.	Re-tighten the loose bolts.
	Pinion gear	Damage to oil seal.	Replace the pinion kit.
Delay in start up, or delay in stopping	Relief valve	Faulty operation.	Replace the relief valve assembly.
	Check valve	Internal leakage.	Replace the body H kit.
Excessive heat generation	Hydraulic motor	Burned or damaged sliding parts.	Replace the hydraulic motor assembly.
	Reduction gear	Damage to the gears.	Replace the pinion kit, carrier kit.
		Damage to bearings	

2) STANDARD FOR PARTS INSPECTION

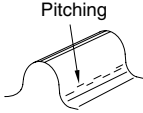
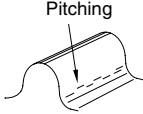
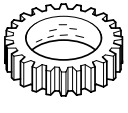
(1) Reduction gear section

Part	Extent of the damage	Inspection standard	Action
A internal gear	Excessive wear of the surface	Pitching area 5% or more of the gear surface 	Replace the pinion kit.
Carrier 1	Damage to spline section	By visual	Replace the carrier kit.
S1 gear b1 gear	Excessive wear of the surface	Pitching area 5% or more of the gear surface 	Replace the carrier kit.
	Excessive wear of the bearing surface	By visual pitching, flaking 	
Ring	Excessive wear of the bearing surface	By visual pitching, flaking 	Replace the carrier kit.
Roller	Excessive wear of the bearing surface	By visual pitching, flaking 	Replace the carrier kit.
Other (screw, etc.)	Damage, excessive rust	-	Replace each part.

(2) Hydraulic motor section

Part	Extent of the damage	Inspection standard	Action
Shaft	Excessive wear of the spline section	Worn depth : 25 μ m or more	Replace the hydraulic motor assembly.
Cylinder barrel	Excessive wear to the sliding surface of the valve plate	Worn depth : 20 μ m or more	Replace the cylinder barrel kit.
Valve plate	Excessive wear to the sliding surface of the cylinder barrel	Worn depth : 20 μ m or more	Replace the cylinder barrel kit.
Piston shoe	Wear of joint section of shoe	Play of piston and shoe : 0.3 mm or more by hand operation	Replace the cylinder barrel kit.
Swash plate	Excessive wear to the sliding surface of the shoe	Worn depth : 0.1 mm or more	Replace the swash plate kit.
Other (screw, etc.)	Damage, excessive rust	-	Replace each part.

4. TRAVEL MOTOR

1) MAINTENANCE STANDARD FOR TRAVEL MOTOR

Travel motors basically don't require maintenance except changing the reducer lubricant. Don't disassemble the motor unless there are problem with it. Refer to the following standards for parts (kits) replacement.

(1) Reducer

No.	Part name	Point to be checked	Standard	Action
1	Body (internal gear)	Engaging tooth surface with B1 and B2 gears	No pitching with 5% or greater (ratio of engaging area to tooth surface) No abnormal damage	Replace
2	Carrier 2	Spline tooth surface	No abnormal damage, wear	Replace whole carrier 2 kit
		Loose of B2 pins	No loose by hand	
3	B1 gears	Tooth surface	No pitching with 5% or greater (ratio of engaging area to tooth surface) No abnormal damage	Replace
		Needle rolling contact surface	No flaking and pitching	
4	B2 gears	Tooth surface	No pitching with 5% or greater (ratio of engaging area to tooth surface) No abnormal damage	Replace whole carrier 2 kit
		Needle rolling contact surface	No flaking and pitching	
5	S1 gear	Tooth surface	No pitching with 5% or greater (ratio of engaging area to tooth surface) No abnormal damage	Replace whole carrier 2 kit
6	S2 gear	Engaging tooth surface with B2 gears	No pitching with 5% or greater (ratio of engaging area to tooth surface) No abnormal damage	Replace
		Spline tooth surface	No abnormal damage, wear	
7	B2 pins	Needle rolling contact surface	No flaking and pitching	Replace whole carrier 2 kit
8	Floating seals	Seat surface	No abnormal damage, wear	Replace
		O-ring surface	No damage, deformation, and hardening	
9	Angular ball bearings	Rolling contact surface	No abnormal damage, flaking	Replace
10	Needles	Rolling contact surface	No flaking and pitching	Replace whole carrier 2 kit
11	O-rings	Surface, hardness	No damage, deformation, and hardening	Replace

(2) Hydraulic valve and motor

No.	Part name	Point to be checked	Standard	Action
12	Body 1	Spool sliding contact surface	No abnormal damage, wear	Relpace whole body 1 kit
13	Counter valve spool Two-speed spool Shuttle spool	Body 1 sliding contact surface	No abnormal damage, wear	Relpace whole body 1 kit
14	Body 2	Spline tooth surface	No abnormal damage, wear	Replace whole body 2 kit
		Control piston sliding contact surface	No abnormal damage, wear Clearance between piston and body 2 is 0.023 mm or smaller	
		Swash plate installaion surface	No abnormal damage, wear	
		Ball sliding contact surface	No abnormal damage, wear	
15	Shaft	Spline tooth surface	No abnormal damage, wear	Replace shaft kit
		Oil seal sliding contact surface	No abnormal damage, wear (0.025 mm or greater)	
16	Cylinder barrel	Piston sliding contact surface	No abnormal damage, wear Clearance between piston and cylinder barrel is 0.030 mm or smaller	Replace cylinder barrel kit
		Valve place sliding contact surface	No abnormal damage, wear (0.020 mm or greater)	Lap or replace cylicder barrel kit
17	Valve plate	Cylinder barrel sliding contact surface	No abnormal damage, wear (0.020 mm or greater)	Lap or replace cylicder barrel kit
18	Pistons Shoes	Cylinder barrel sliding contact surface	No abnormal damage, wear (0.020 mm or greater)	Replace cylinder barrel kit
		Swash plate sliding contact surface	No abnormal damage, wear (0.020 mm or greater)	Lap or replace cylicder barrel kit
		Loose of shoe calking part	Loose is smaller than 0.3 mm	Replace cylinder barrel kit
19	Shoe holder	Barrel holder sliding contact surface	No abnormal damage, wear	Replace cylinder barrel kit
20	Barrel holder	Spline tooth surface	No abnormal damage, wear	Replace cylinder barrel kit
		Shoe holder sliding contact surface	No abnormal damage, wear	
21	Swash plate	Shoe sliding contact surface	No abnormal damage, wear (0.020 mm or greater)	Lap or replace
		Ball sliding contact surface	No abnormal damage, wear	Replace
22	Control piston	Body 2 sliding contact surface	Clearance between piston and body 2 is 0.023 mm or smaller	Replace body 2 kit
23	Oil seal	Lip surface	No abnormal damage, wear and deformation	Replace
24	Ball bearing	Rolling contact surface	No abnormal damage, flaking	Replace
25	Springs	Surface	No crack	Replace
26	O-rings	Surface and hardness	No damage, deformation, and hardening	Replace

2) FAILURE DIAGNOSIS OF TRAVEL MOTOR

Failure detail	Major causes	Countermeasure
Doesn't start	Operating defect in hydraulic equipment except travel motors	Inspect and repair or replace each equipment. Check that normal working pressure is supplied to the motor inlet port.
	Defect in reducer - Damage of inner parts	Replace the damaged part (kit).
	Defect in hydraulic motor - Oil leakage due to abnormal wear of the sliding parts - Damage of inner parts	Replace the worn part (kit). Replace the damaged part (kit).
	Defect in hydraulic valve - Spool doesn't move Foreign object is caught in the spool sliding part. Choke is clogged	Remove the foreign object. In case of much leakage, replace the body 1 kit. Remove the foreign object.
Doesn't stop or stop slowly	Defect in hydraulic valve - Spool doesn't return Foreign object is caught in the spool sliding part. Choke is clogged. Spring is damaged. - Check valve doesn't close due to foreign object being caught on the seat.	Remove the foreign object. In case of much leakage, replace the body 1 kit. Remove the foreign object. Replace the body 1 kit. Remove the foreign object. In case of much leakage, replace the body 1 kit.
	Rotating speed is slow	Prescribed flow rate is not supplied to the motor due to operating defect in the pump. Volumetric efficiency declines due to defect in the motor. - Abnormal wear of sliding parts Volumetric efficiency declines due to defect in the hydraulic valve. - Abnormal wear of main spool and two speed spool sliding part

Failure detail	Major causes	Countermeasure
Doesn't change to two speed	Operating defect in hydraulic equipment except travel motors	Inspect and repair or replace each equipment. Check that normal pressure is supplied to the pilot port.
	Defect in the hydraulic valve - Two speed spool doesn't move due to foreign object being caught in the spool sliding part. - Choke in the two speed pilot line is clogged.	Remove the foreign object. In case of much leakage, replace the body 1 kit. Remove the foreign object.
	Defect in the hydraulic motor - Control piston doesn't move. Foreign object is caught in the piston sliding part. Oil leakage due to abnormal wear of the sliding part. Oil leakage due to damage of O-ring located between body 1 and body 2.	Remove the foreign object. In case of much leakage, replace the body 2 kit. Replace the worn part (kit). Replace the O-ring.
Doesn't change to one speed	Operating defect in hydraulic equipment except travel motors	Inspect and repair or replace each equipment. Check that normal pressure is supplied to the pilot port.
	Defect in the hydraulic valve - Two speed spool doesn't move. Foreign object is caught in the spool sliding part. Damage of spring - Choke in the two speed pilot line is clogged.	Remove the foreign object. In case of much leakage, replace the body 1 kit. Replace the body 1 kit. Remove the foreign object.
Tracking deviation	Same as No.3, 4 and 5	-
Oil leakage	Oil leakage due to damage of O-rings. - Damage of O-ring located in the reducer cover. - Damage of O-rings located between body 1 and body 2.	Replace the O-ring. Replace the O-ring.
	Oil leakage from the floating seals - Abnormal wear of the seat surface or damage of the O-ring. - Pressure in the reducer casing rises due to damage of the oil seal.	Replace the floating seal. Replace the oil seal.

5. TURNING JOINT

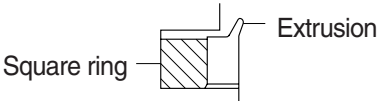
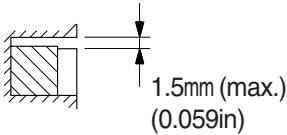
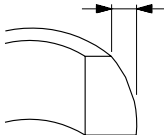
Parts Name		Check Points	Measures
Body, Stem	Sliding surface with sealing sections.	Plating worn or peeled due to seizure or contamination.	Replace
	Sliding surface between body and stem other than sealing section.	· Worn abnormality or damaged more than 0.1 mm (0.0039 in) in depth due to seizure contamination.	Replace
		· Damaged more than 0.1 mm (0.0039 in) in depth.	Smooth with oilstone.
	Sliding surface with thrust plate.	· Worn more than 0.5 mm (0.02 in) or abnormality.	Replace
		· Worn less than 0.5 mm (0.02 in).	Smooth
	· Damage due to seizure or contamination remediable within wear limit (0.5 mm) (0.02 in).	Smooth	
Cover	Sliding surface with thrust plate.	· Worn more than 0.5 mm (0.02 in) or abnormality.	Replace
		· Worn less than 0.5 mm (0.02 in).	Smooth
		· Damage due to seizure or contamination remediable within wear limit (0.5 mm) (0.02 in).	Replace
Seal set	-	· Extruded excessively from seal groove square ring. 	Replace
	-	· Slipper ring 1.5 mm (0.059 in) narrower than seal groove, or narrower than back ring. 	Replace
	-	· Worn more than 0.5 mm (0.02 in) ~ 1.5 mm (MAX.) (0.059 in) 	Replace

6. CYLINDER

Part name	Inspecting section	Inspection item	Remedy
Piston rod	· Neck of rod pin	· Presence of crack	· Replace
	· Weld on rod hub	· Presence of crack	· Replace
	· Stepped part to which piston is attached.	· Presence of crack	· Replace
	· Threads	· Presence of crack	· Recondition or replace
	· Plated surface	· Plating is not worn off to base metal.	· Replace or replate
		· Rust is not present on plating. · Scratches are not present.	· Replace or replate · Recondition, replate or replace
	· Rod	· Wear of O.D.	· Recondition, replate or replace
· Bushing at mounting part	· Wear of I.D.	· Replace	
Cylinder tube	· Weld on bottom	· Presence of crack	· Replace
	· Weld on head	· Presence of crack	· Replace
	· Weld on hub	· Presence of crack	· Replace
	· Tube interior	· Presence of faults	· Replace if oil leak is seen
	· Bushing at mounting part	· Wear on inner surface	· Replace
Gland	· Bushing	· Flaw on inner surface	· Replace if flaw is deeper than coating