

# SECTION 1 GENERAL



Group 1 Safety Hints	1-1
Group 2 Specifications	1-9

# SECTION 1 GENERAL

## GROUP 1 SAFETY

### FOLLOW SAFE PROCEDURE

Unsafe work practices are dangerous. Understand service procedure before doing work; Do not attempt shortcuts.

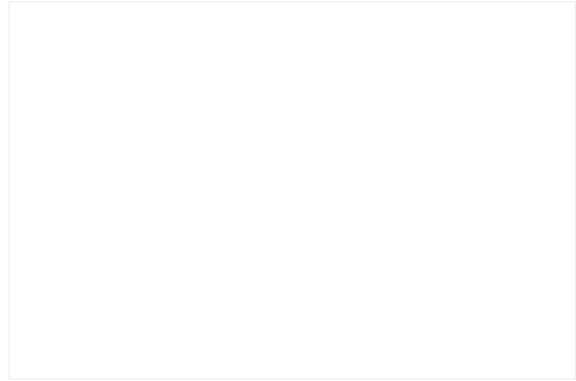

### WEAR PROTECTIVE CLOTHING

Wear close fitting clothing and safety equipment appropriate to the job.

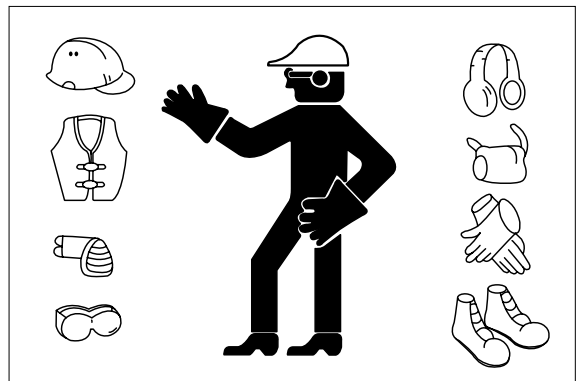

### WARN OTHERS OF SERVICE WORK

Unexpected machine movement can cause serious injury.

Before performing any work on the excavator, attach a 「Do Not Operate」 tag on the right side control lever.

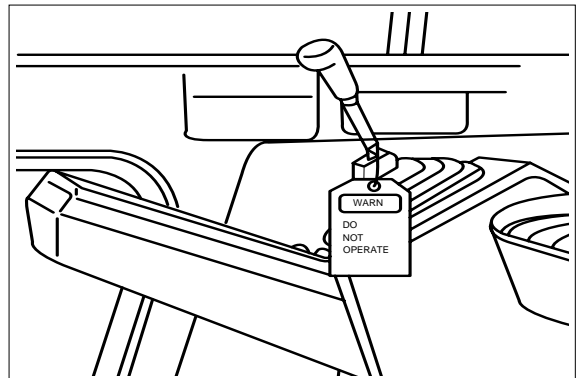

### USE HANDHOLDS AND STEPS

Falling is one of the major causes of personal injury. When you get on and off the machine, always maintain a three point contact with the steps and handrails and face the machine. Do not use any controls as handholds.

Never jump on or off the machine. Never mount or dismount a moving machine.

Be careful of slippery conditions on platforms, steps, and handrails when leaving the machine.

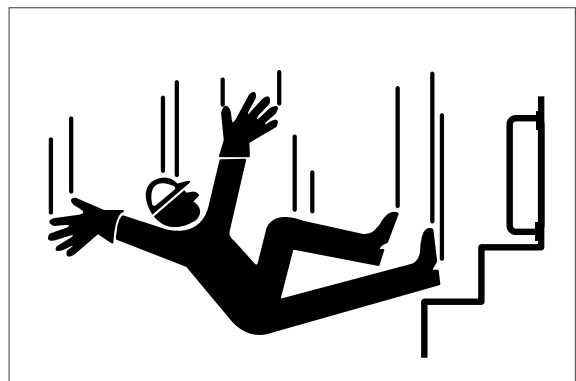

## PREPARE FOR EMERGENCIES

Be prepared if a fire starts.

Keep a first aid kit and fire extinguisher handy.

Keep emergency numbers for doctors, ambulance service, hospital, and fire department near your telephone.

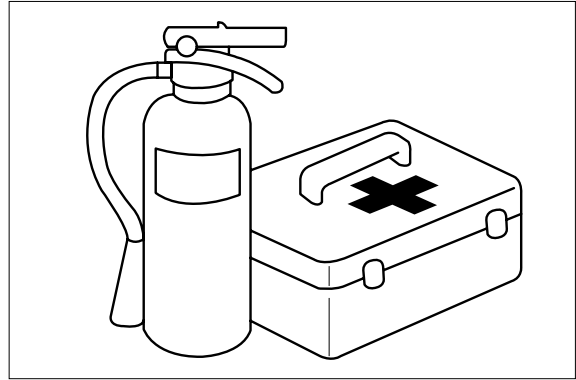

## PROTECT AGAINST FLYING DEBRIS

Guard against injury from flying pieces of metal or debris; Wear goggles or safety glasses.

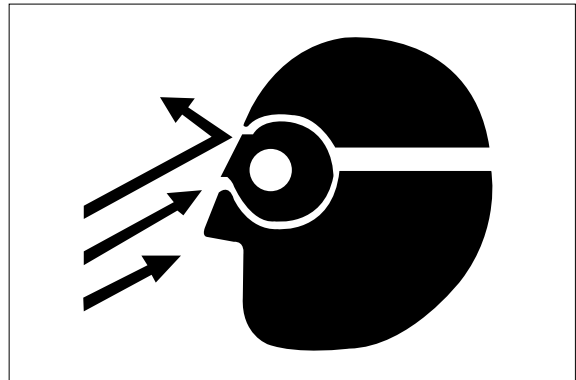

## PROTECT AGAINST NOISE

Prolonged exposure to loud noise can cause impairment or loss of hearing.

Wear a suitable hearing protective device such as earmuffs or earplugs to protect against objectionable or uncomfortable loud noises.

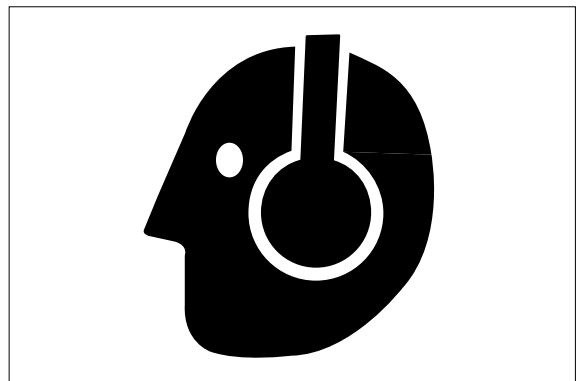

## AVOID POWER LINES

Serious injury or death can result from contact with electric lines.

Never move any part of the machine or load closer to electric line than 3m(10ft) plus twice the line insulator length.

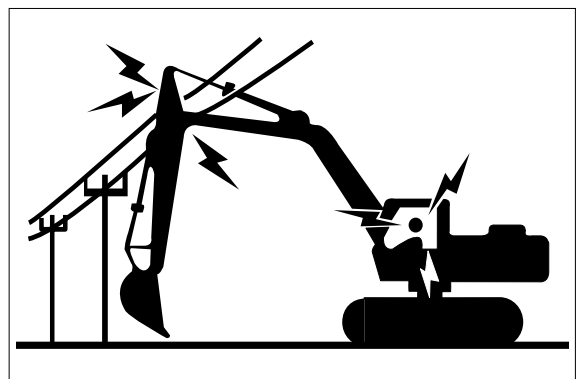

## KEEP RIDERS OFF EXCAVATOR

Only allow the operator on the excavator. Keep riders off.

Riders on excavator are subject to injury such as being struck by foreign objects and being thrown off the excavator. Riders also obstruct the operator's view resulting in the excavator being operated in an unsafe manner.

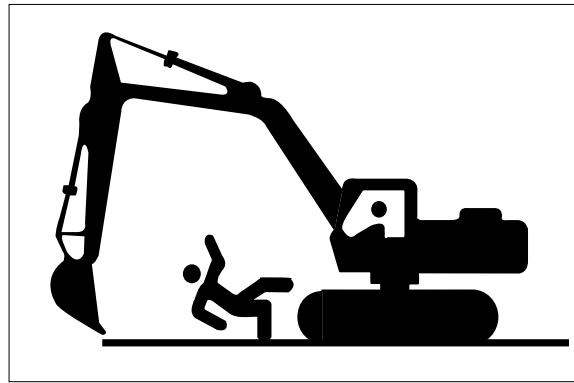

## MOVE AND OPERATE MACHINE SAFELY

Bystanders can be run over. Know the location of bystanders before moving, swinging, or operating the machine.

Always keep the travel alarm in working condition. It warns people when the excavator starts to move.

Use a signal person when moving, swinging, or operating the machine in congested areas. Coordinate hand signals before starting the excavator.

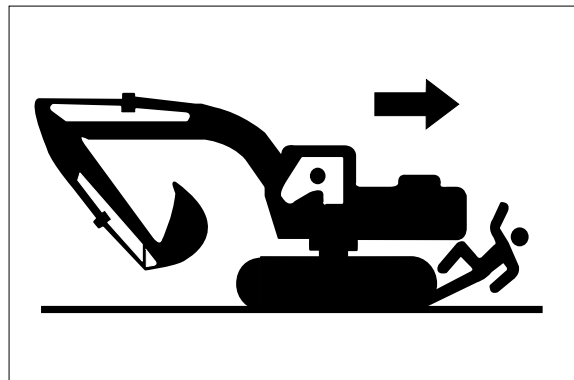

## OPERATE ONLY FROM OPERATOR'S SEAT

Avoid possible injury machine damage. Do not start engine by shorting across starter terminals.

NEVER start engine while standing on ground. Start engine only from operator's seat.



## PARK MACHINE SAFELY

Before working on the machine:

- Park machine on a level surface.
- Lower bucket to the ground.
- Turn auto idle switch off.
- Run engine at 1/2 speed without load for 2 minutes.
- Turn key switch to OFF to stop engine. Remove key from switch.
- Move pilot control shutoff lever to locked position.
- Allow engine to cool.

### SUPPORT MACHINE PROPERLY

Always lower the attachment or implement to the ground before you work on the machine. If you must work on a lifted machine or attachment, securely support the machine or attachment.

Do not support the machine on cinder blocks, hollow tiles, or props that may crumble under continuous load. Do not work under a machine that is supported solely by a jack. Follow recommended procedures in this manual.

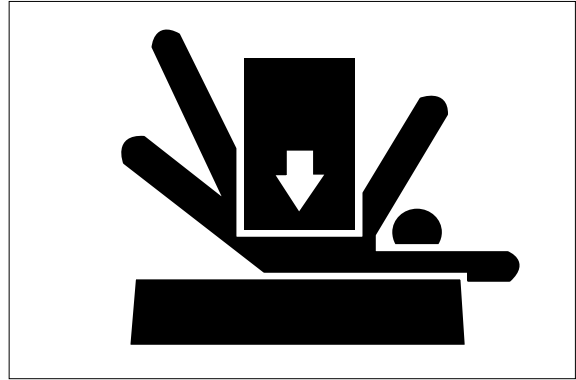

### SERVICE COOLING SYSTEM SAFELY

Explosive release of fluids from pressurized cooling system can cause serious burns.

Shut off engine. Only remove filler cap when cool enough to touch with bare hands.

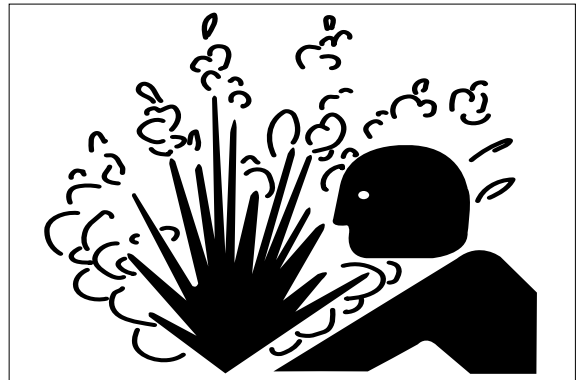

### HANDLE FLUIDS SAFELY-AVOID FIRES

Handle fuel with care; It is highly flammable. Do not refuel the machine while smoking or when near open flame or sparks. Always stop engine before refueling machine.

Fill fuel tank outdoors.

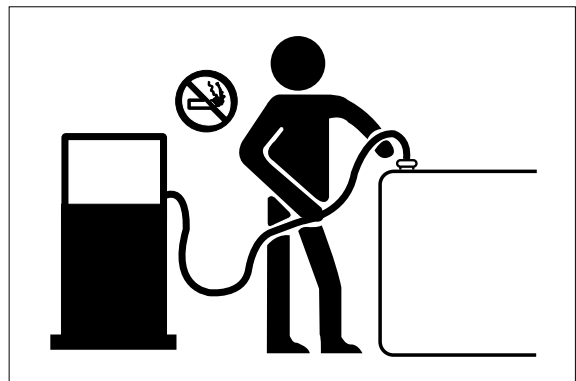

Store flammable fluids away from fire hazards. Do not incinerate or puncture pressurized containers.

Make sure machine is clean of trash, grease, and debris.

Do not store oily rags; They can ignite and burn spontaneously.

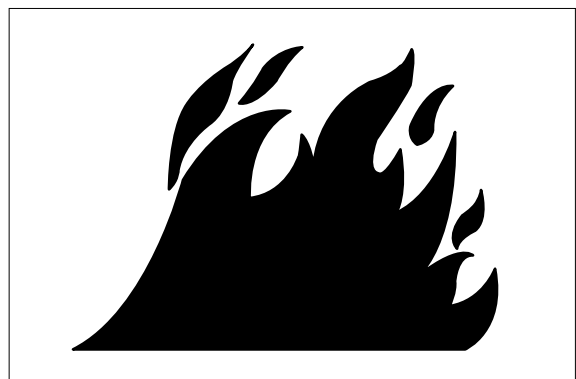

## BEWARE OF EXHAUST FUMES

Prevent asphyxiation. Engine exhaust fumes can cause sickness or death.

If you must operate in a building, be positive there is adequate ventilation. Either use an exhaust pipe extension to remove the exhaust fumes or open doors and windows to bring enough outside air into the area.

## REMOVE PAINT BEFORE WELDING OR HEATING

Avoid potentially toxic fumes and dust.

Hazardous fumes can be generated when paint is heated by welding, soldering, or using a torch.

Do all work outside or in a well ventilated area. Dispose of paint and solvent properly.

Remove paint before welding or heating:

- If you sand or grind paint, avoid breathing the dust. Wear an approved respirator.
- If you use solvent or paint stripper, remove stripper with soap and water before welding. Remove solvent or paint stripper containers and other flammable material from area. Allow fumes to disperse at least 15 minutes before welding or heating.

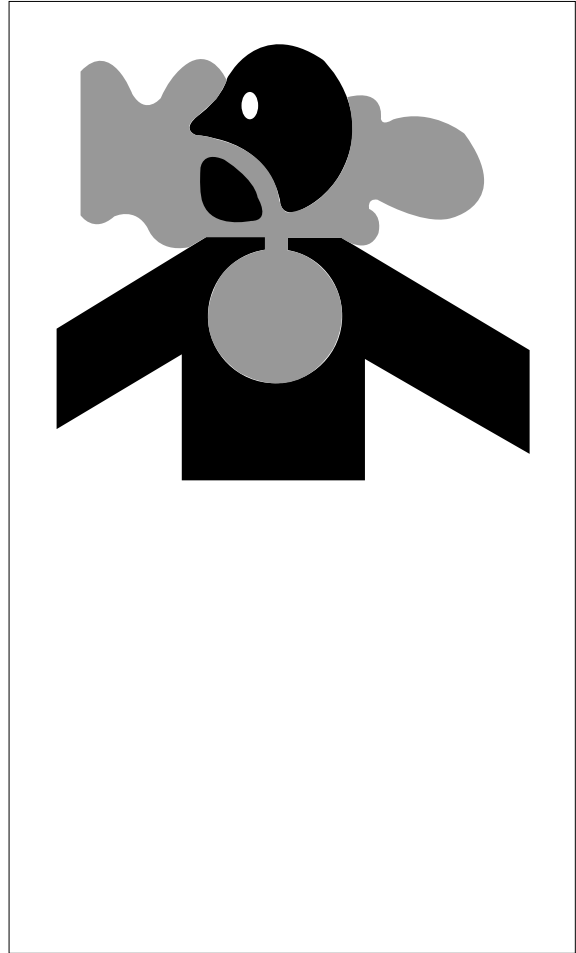

## ILLUMINATE WORK AREA SAFELY

Illuminate your work area adequately but safely. Use a portable safety light for working inside or under the machine. Make sure the bulb is enclosed by a wire cage. The hot filament of an accidentally broken bulb can ignite spilled fuel or oil.

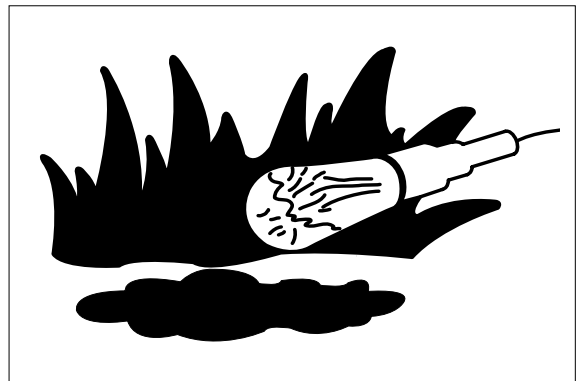

### SERVICE MACHINE SAFELY

Tie long hair behind your head. Do not wear a necktie, scarf, loose clothing or necklace when you work near machine tools or moving parts. If these items were to get caught, severe injury could result.

Remove rings and other jewelry to prevent electrical shorts and entanglement in moving parts.

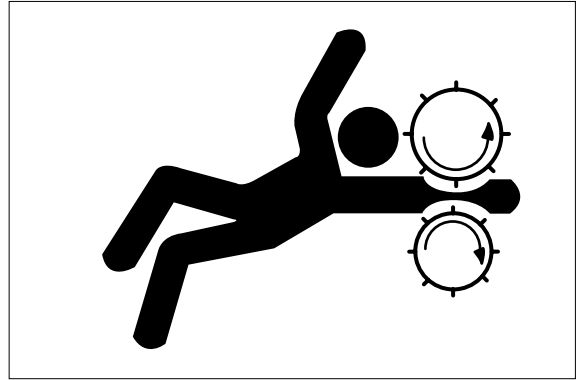

### STAY CLEAR OF MOVING PARTS

Entanglements in moving parts can cause serious injury.

To prevent accidents, use care when working around rotating parts.

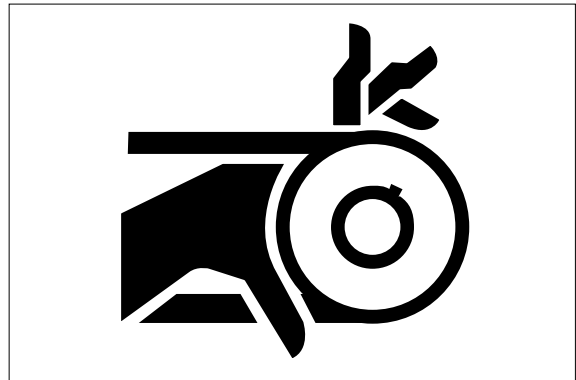

### AVOID HIGH PRESSURE FLUIDS

Escaping fluid under pressure can penetrate the skin causing serious injury.

Avoid the hazard by relieving pressure before disconnecting hydraulic or other lines. Tighten all connections before applying pressure.

Search for leaks with a piece of cardboard. Protect hands and body from high pressure fluids.

If an accident occurs, see a doctor immediately. Any fluid injected into the skin must be surgically removed within a few hours or gangrene may result.

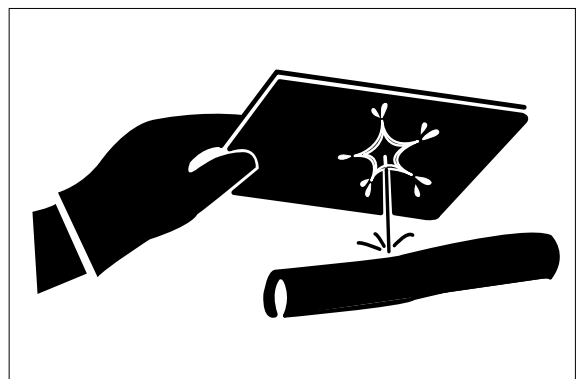

## AVOID HEATING NEAR PRESSURIZED FLUID LINES

Flammable spray can be generated by heating near pressurized fluid lines, resulting in severe burns to yourself and bystanders. Do not heat by welding, soldering, or using a torch near pressurized fluid lines or other flammable materials.

Pressurized lines can be accidentally cut when heat goes beyond the immediate flame area. Install fire resisting guards to protect hoses or other materials.



## PREVENT BATTERY EXPLOSIONS

Keep sparks, lighted matches, and flame away from the top of battery. Battery gas can explode.

Never check battery charge by placing a metal object across the posts. Use a volt-meter or hydrometer.

Do not charge a frozen battery; It may explode. Warm battery to 16°C (60°F).



## PREVENT ACID BURNS

Sulfuric acid in battery electrolyte is poisonous. It is strong enough to burn skin, eat holes in clothing, and cause blindness if splashed into eyes.

Avoid the hazard by:

1. Filling batteries in a well-ventilated area.
2. Wearing eye protection and rubber gloves.
3. Avoiding breathing fumes when electrolyte is added.
4. Avoiding spilling or dripping electrolyte.
5. Use proper jump start procedure.

If you spill acid on yourself:

1. Flush your skin with water.
2. Apply baking soda or lime to help neutralize the acid.
3. Flush your eyes with water for 10-15 minutes. Get medical attention immediately.

If acid is swallowed:

1. Drink large amounts of water or milk.
2. Then drink milk of magnesia, beaten eggs, or vegetable oil.
3. Get medical attention immediately.

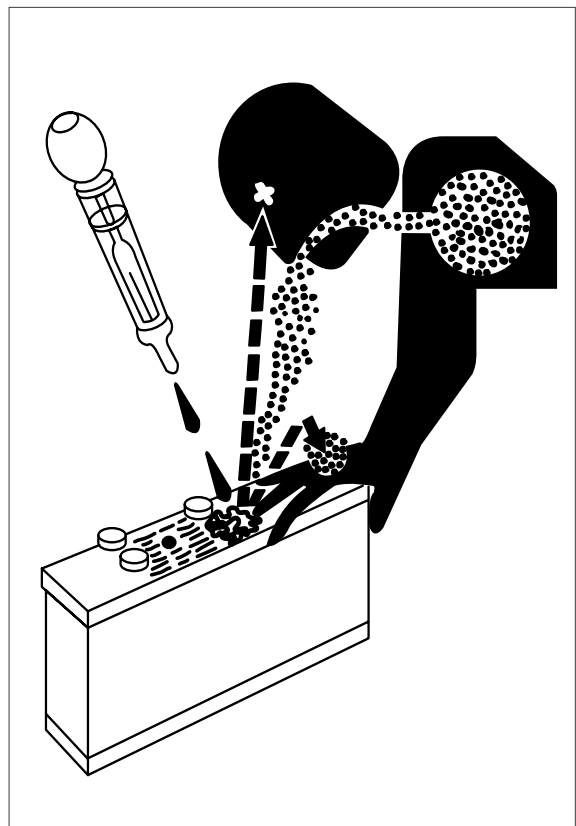

## USE TOOLS PROPERLY

Use tools appropriate to the work. Makeshift tools, parts, and procedures can create safety hazards.

Use power tools only to loosen threaded tools and fasteners.

For loosening and tightening hardware, use the correct size tools. DO NOT use U.S. measurement tools on metric fasteners. Avoid bodily injury caused by slipping wrenches.

Use only recommended replacement parts. (See Parts catalogue.)

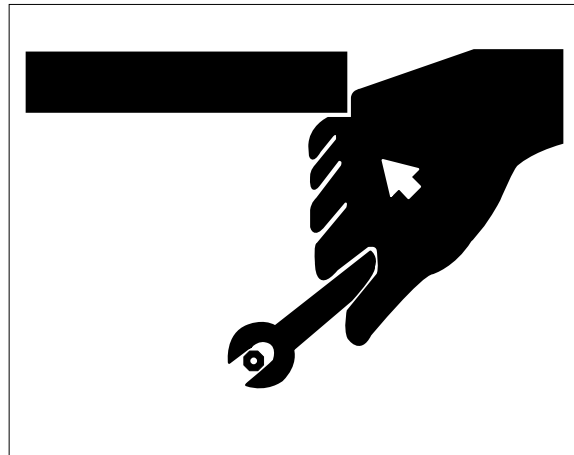

## DISPOSE OF FLUIDS PROPERLY

Improperly disposing of fluids can harm the environment and ecology. Before draining any fluids, find out the proper way to dispose of waste from your local environmental agency.

Use proper containers when draining fluids. Do not use food or beverage containers that may mislead someone into drinking from them.

DO NOT pour oil into the ground, down a drain, or into a stream, pond, or lake. Observe relevant environmental protection regulations when disposing of oil, fuel, coolant, brake fluid, filters, batteries, and other harmful waste.

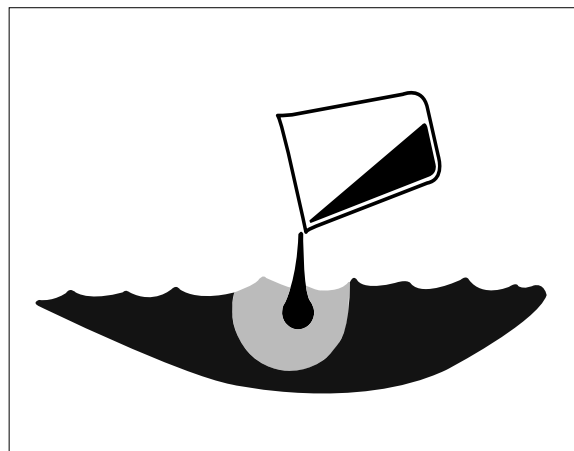

## REPLACE SAFETY SIGNS

Replace missing or damaged safety signs. See the machine operator's manual for correct safety sign placement.

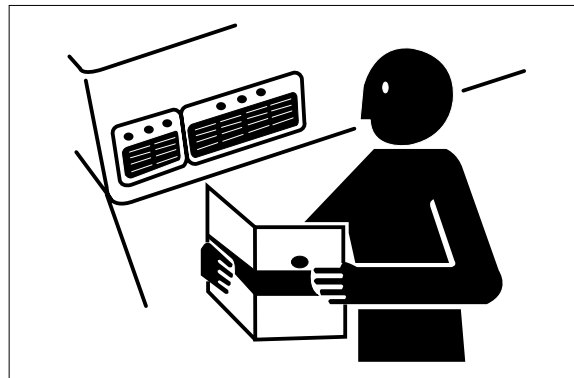

## LIVE WITH SAFETY

Before returning machine to customer, make sure machine is functioning properly, especially the safety systems. Install all guards and shields.

# GROUP 2 SPECIFICATIONS

## 1. MAJOR COMPONENT

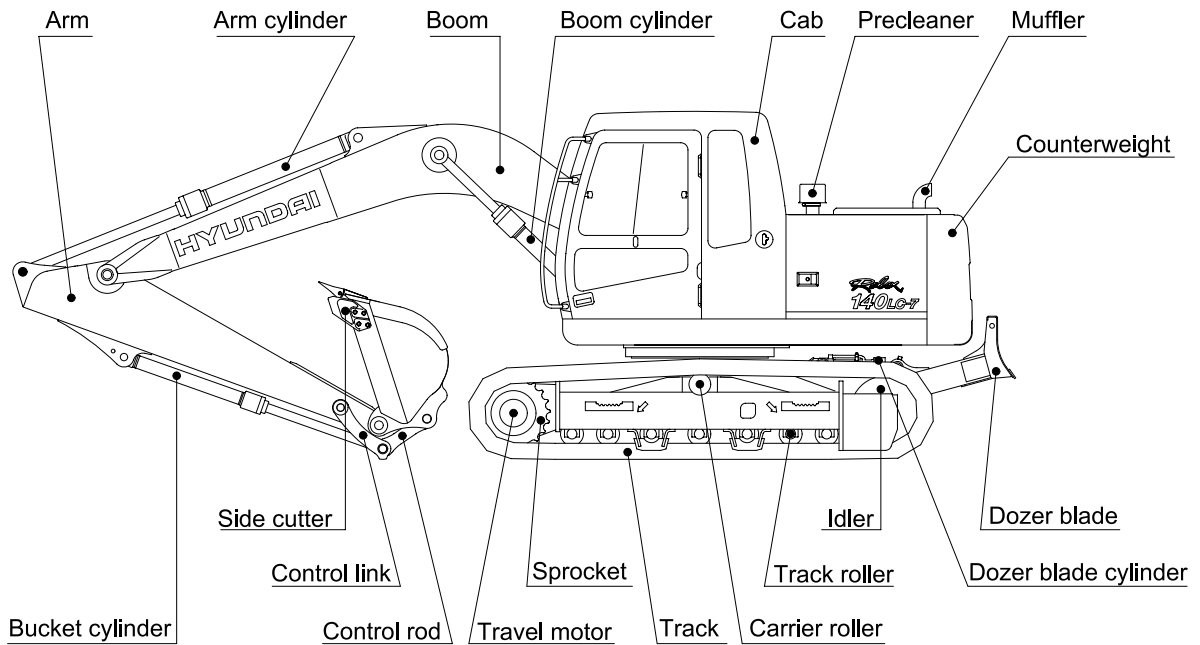
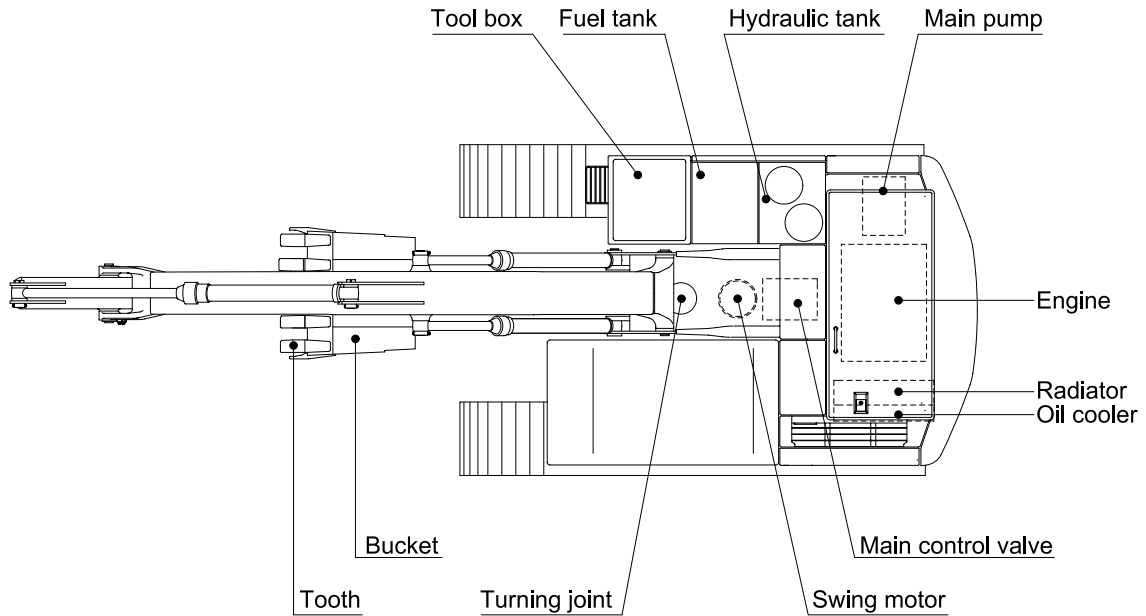

14072SP00D

## 2. SPECIFICATIONS

### 1) R140LC-7

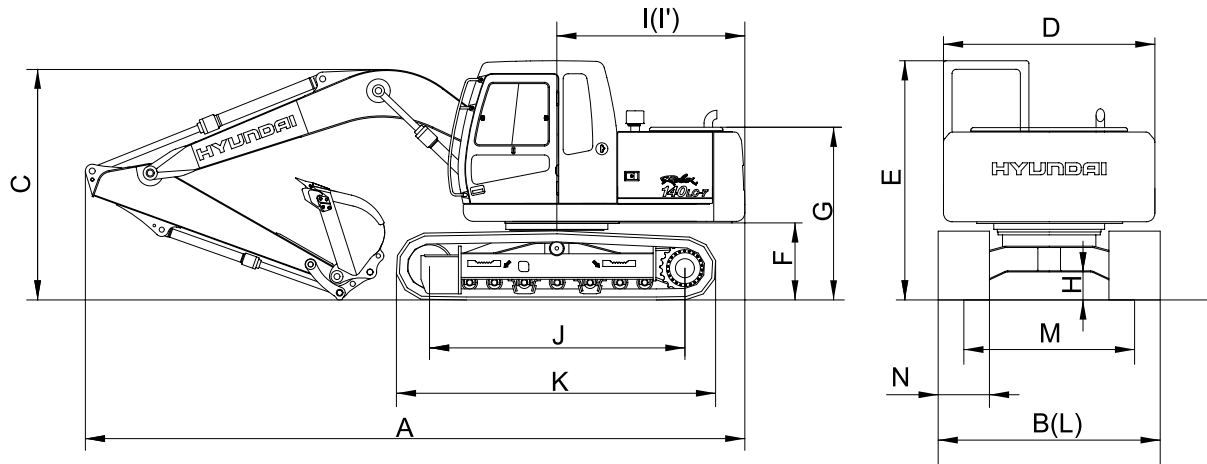

14072SP01

Description		Unit	Specification
Operating weight		kg(lb)	13980(30860)
Bucket capacity(PCSA heaped), standard		m <sup>3</sup> (yd <sup>3</sup> )	0.58(0.76)
Overall length	A	mm(ft-in)	7800(25' 7")
Overall width, with 600mm shoe	B		2600( 8' 6")
Overall height	C		2760( 9' 1")
Superstructure width	D		2500( 8' 2")
Overall height of cab	E		2820( 9' 3")
Ground clearance of counterweight	F		935( 3' 1")
Engine cover height	G		2037( 6' 8")
Minimum ground clearance	H		*2200( 7' 2")
Rear-end distance	I		440( 1' 5")
Rear-end swing radius	I'		2285( 7' 6")
Distance between tumbler	J		2310( 7' 7")
Undercarriage length	K		3000( 9'10")
Undercarriage width	L		3750(12' 4")
Track gauge	M		2600( 8' 6")
Track shoe width, standard	N		2000( 6' 7")
Travel speed(Low/high)			km/hr(mph)
Swing speed		rpm	3.3/5.5(2.1/3.4)
Gradeability		Degree(%)	13.6
Ground pressure(600mm shoe)		kgf/cm <sup>2</sup> (psi)	35(70)
			0.36(5.12)

\* : TIER II

## 2) R140LC-7, 2-PIECE BOOM

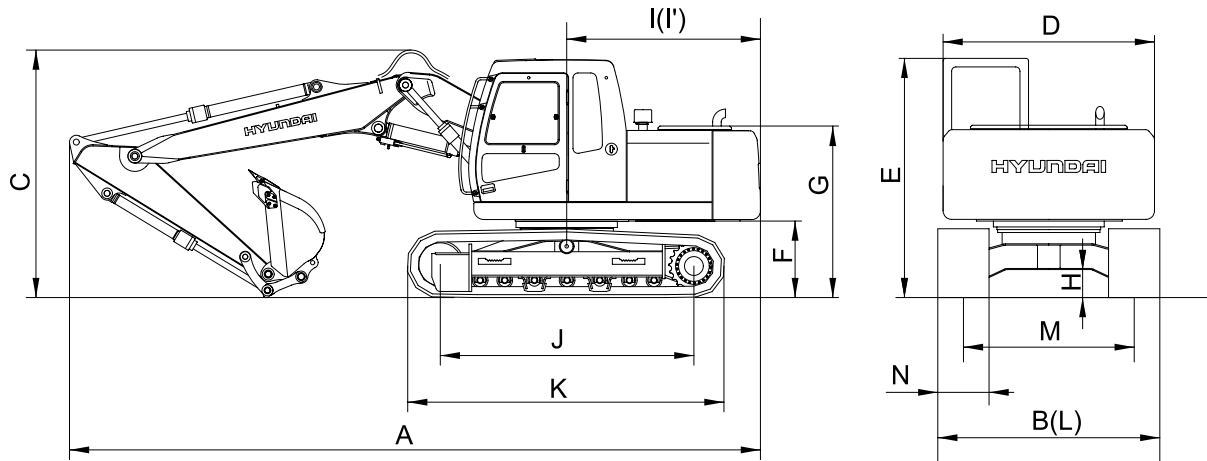

14072SP01A

Description		Unit	Specification
Operating weight		kg(lb)	13980(30860)
Bucket capacity(PCSA heaped), standard		m <sup>3</sup> (yd <sup>3</sup> )	0.58(0.76)
Overall length	A	mm(ft-in)	8120(26' 8")
Overall width, with 600mm shoe	B		2600( 8' 6")
Overall height	C		2940( 9' 8")
Superstructure width	D		2500( 8' 2")
Overall height of cab	E		2820( 9' 3")
Ground clearance of counterweight	F		935( 3' 1")
Engine cover height	G		2037( 6' 8") *2200( 7' 2")
Minimum ground clearance	H		440( 1' 5")
Rear-end distance	I		2285( 7' 6")
Rear-end swing radius	I'		2310( 7' 7")
Distance between tumbler	J		3000( 9'10")
Undercarriage length	K		3750(12' 4")
Undercarriage width	L		2600( 8' 6")
Track gauge	M		2000( 6' 7")
Track shoe width, standard	N		600(24")
Travel speed(Low/high)		km/hr(mph)	3.3/5.5(2.1/3.4)
Swing speed		rpm	13.6
Gradeability		Degree(%)	35(70)
Ground pressure(600mm shoe)		kgf/cm <sup>2</sup> (psi)	0.36(5.12)

\* : TIER II

### 3) R140LCD-7

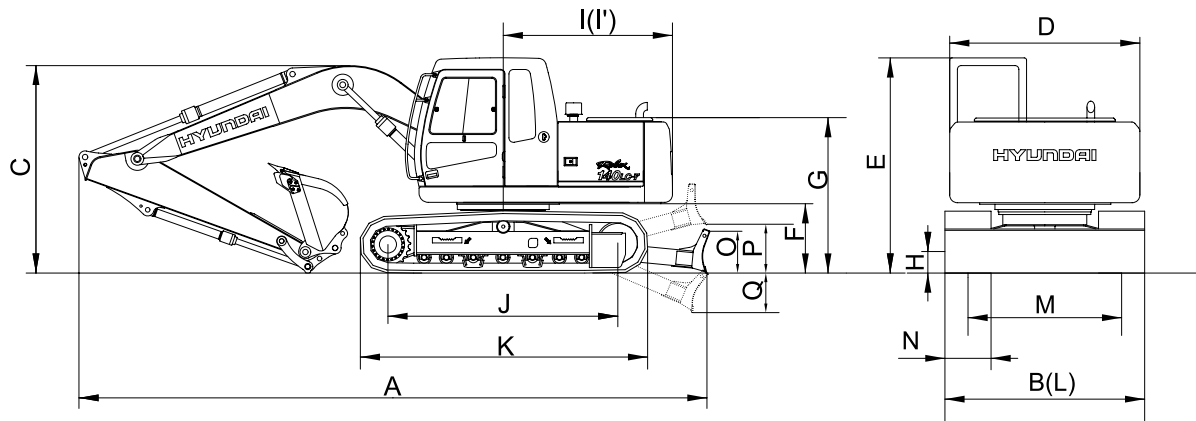

14072SP01D

Description		Unit	Specification
Operating weight		kg(lb)	14800(32630)
Bucket capacity(PCSA heaped), standard		m <sup>3</sup> (yd <sup>3</sup> )	0.58(0.76)
Overall length	A	mm(ft-in)	8210(26'11")
Overall width, with 600mm shoe	B		2600( 8' 6")
Overall height	C		2760( 9' 1")
Superstructure width	D		2500( 8' 2")
Overall height of cab	E		2820( 9' 3")
Ground clearance of counterweight	F		935( 3' 1")
Engine cover height	G		2037( 6' 8") *2200( 7' 2")
Minimum ground clearance	H		440( 1' 5")
Rear-end distance	I		2285( 7' 6")
Rear-end swing radius	I'		2310( 7' 7")
Distance between tumblers	J		3000( 9'10")
Undercarriage length	K		3750(12' 4")
Undercarriage width	L		2600( 8' 6")
Track gauge	M		2000( 6' 7")
Track shoe width, standard	N		600(24")
Height of blade	O		550( 1'10")
Ground clearance of blade up	P		625( 2' 1")
Depth of blade down	Q		515( 1' 8")
Travel speed(Low/high)		km/hr(mph)	3.3/5.5(2.1/3.4)
Swing speed		rpm	13.6
Gradeability		Degree(%)	35(70)
Ground pressure(600mm shoe)		kgf/cm <sup>2</sup> (psi)	0.38(5.40)

\* : TIER II

#### 4) R140LCM-7

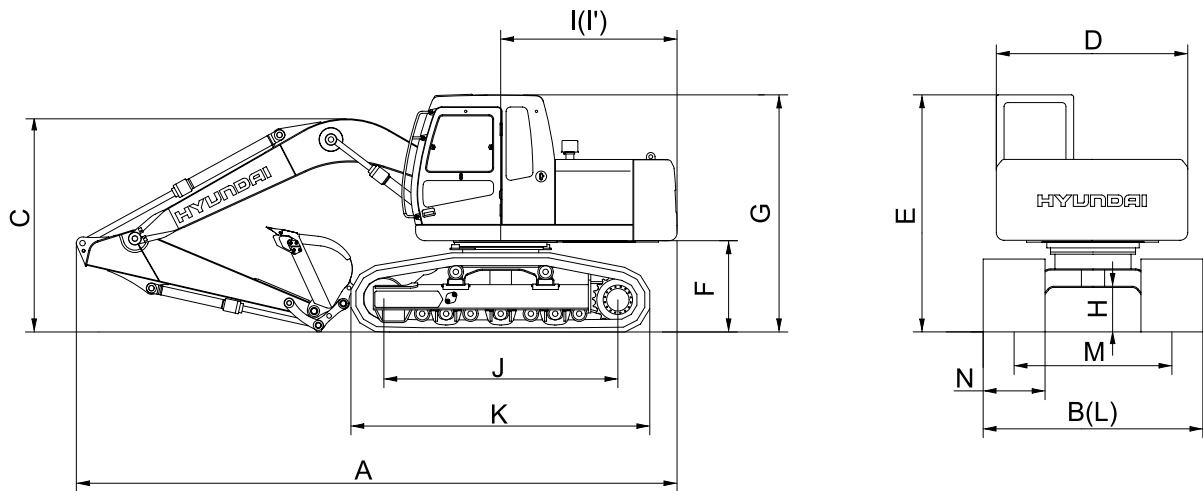

14072SP01M

Description		Unit	Specification
Operating weight		kg(lb)	16880(37210)
Bucket capacity(PCSA heaped), standard		m <sup>3</sup> (yd <sup>3</sup> )	0.58(0.76)
Overall length	A	mm(ft-in)	7770(25' 6")
Overall width, with 800mm shoe	B		2910( 9' 7")
Overall height	C		2810( 9' 3")
Superstructure width	D		2500( 8' 2")
Overall height of cab	E		3080(10' 1")
Ground clearance of counterweight	F		1195( 3'11")
Engine cover height	G		2300( 7' 6")
Minimum ground clearance	H		*2460( 8' 1")
Rear-end distance	I		600( 2' 0")
Rear-end swing radius	I'		2310( 7' 7")
Distance between tumblers	J		2280( 7' 6")
Undercarriage length	K		3030( 9' 6")
Undercarriage width	L		3860(12' 8")
Track gauge	M		2910( 9' 7")
Track shoe width, standard	N		2040( 6' 8")
Travel speed(Low/high)			km/hr(mph)
Swing speed		rpm	13.6
Gradeability		Degree(%)	35(70)
Ground pressure(800mm shoe)		kgf/cm <sup>2</sup> (psi)	0.32(4.55)

\* : TIER II

### 3. WORKING RANGE

#### 1) R140LC/LCD-7

(1) 4.60m(15' 1") boom

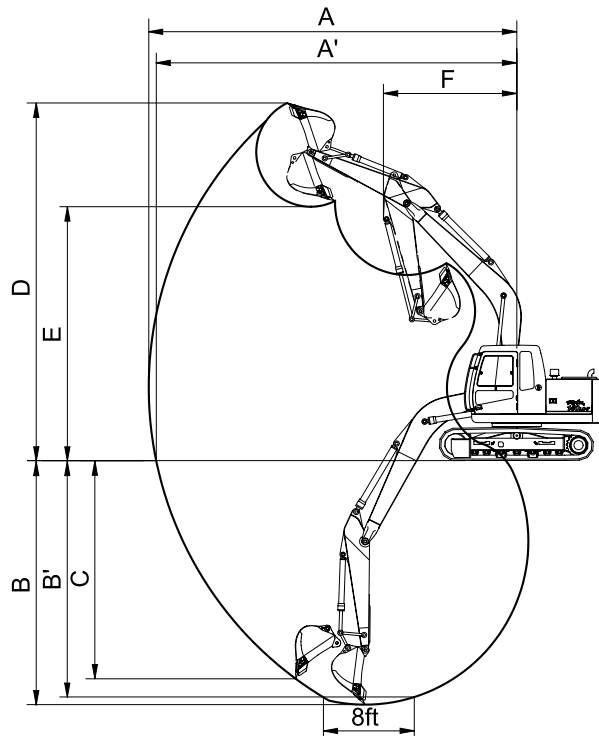

14072SP04

Description		1.90m(6' 3") Arm	2.10m(6' 11") Arm	2.50m( 8' 2") Arm	3.00m( 9' 10") Arm
Max digging reach	A	7750mm(25' 5")	7920mm(26' 0")	8340mm(27' 4")	8800mm(28'10")
Max digging reach on ground	A'	7600mm(24'11")	7780mm(25' 6")	8200mm(26'11")	8670mm(28' 5")
Max digging depth	B	5000mm(16' 5")	5200mm(17' 1")	5600mm(18' 4")	6100mm(20' 0")
Max digging depth (8ft level)	B'	4730mm(15' 6")	4950mm(16' 3")	5390mm(17' 8")	5910mm(19' 5")
Max vertical wall digging depth	C	4460mm(14' 8")	4590mm(15' 1")	5120mm(16'10")	5660mm(18' 7")
Max digging height	D	8060mm(26' 5")	8140mm(26' 8")	8520mm(27'11")	8730mm(28' 8")
Max dumping height	E	5630mm(18' 6")	5710mm(18' 9")	6080mm(19'11")	6280mm(20' 7")
Min swing radius	F	2620mm( 8' 7")	2680mm( 8'10")	2620mm( 8' 7")	2660mm( 8' 8")
Bucket digging force	SAE	83.4[91]kN	83.4[91]kN	83.4[91]kN	83.4[91]kN
		8500[9270]kgf	8500[9270]kgf	8500[9270]kgf	8500[9270]kgf
		18740[20440]lbf	18740[20440]lbf	18740[20440]lbf	18740[20440]lbf
	ISO	96.1[104.8]kN	96.1[104.8]kN	96.1[104.8]kN	96.1[104.8]kN
		9800[10690]kgf	9800[10690]kgf	9800[10690]kgf	9800[10690]kgf
		21610[23570]lbf	21610[23570]lbf	21610[23570]lbf	21610[23570]lbf
Arm crowd force	SAE	74.5[81.3]kN	71.6[78.1]kN	61.8[67.4]kN	53.9[59.0]kN
		7600[8290]kgf	7300[7960]kgf	6300[6870]kgf	5500[6020]kgf
		16760[18280]lbf	16090[17550]lbf	13890[15150]lbf	12130[13270]lbf
	ISO	78.5[85.6]kN	75.5[82.4]kN	64.7[70.6]kN	56.9[62.1]kN
		8000[8730]kgf	7700[8400]kgf	6600[7200]kgf	5800[6330]kgf
		17640[19240]lbf	16980[18520]lbf	14550[15870]lbf	12790[13950]lbf

[ ] : Power boost

**(2) 4.10m(13' 5") boom**

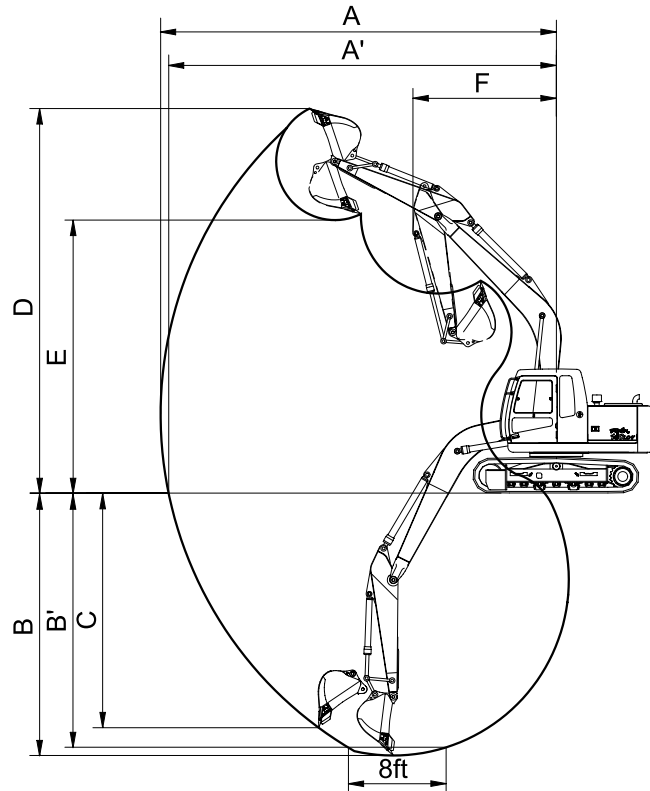

14072SP04

Description		1.90m(6' 3") Arm	2.10m(6' 11") Arm
Max digging reach	A	7250mm(23' 9")	7420mm(24' 4")
Max digging reach on ground	A'	7100mm(23' 4")	7270mm(23'10")
Max digging depth	B	4570mm(15' 0")	4770mm(15' 8")
Max digging depth (8ft level)	B'	4310mm(14' 2")	4520mm(14'10")
Max vertical wall digging depth	C	4090mm(14' 5")	4220mm(13'10")
Max digging height	D	7660mm(25' 2")	7730mm(25' 4")
Max dumping height	E	5220mm(17' 2")	5290mm(17' 4")
Min swing radius	F	2350mm( 7' 9")	2470mm( 8' 1")
Bucket digging force	SAE	83.4[91]kN	83.4[91]kN
		8500[9270]kgf	8500[9270]kgf
		18740[20440]lbf	18740[20440]lbf
	ISO	96.1[104.8]kN	96.1[104.8]kN
		9800[10690]kgf	9800[10690]kgf
		21610[23570]lbf	21610[23570]lbf
Arm crowd force	SAE	74.5[81.3]kN	71.6[78.1]kN
		7600[8290]kgf	7300[7960]kgf
		16760[18280]lbf	16090[17550]lbf
	ISO	78.5[85.6]kN	75.5[82.4]kN
		8000[8730]kgf	7700[8400]kgf
		17640[19240]lbf	16980[18520]lbf

[ ]: Power boost

**(3) 4.90m(16' 1") 2-piece boom**

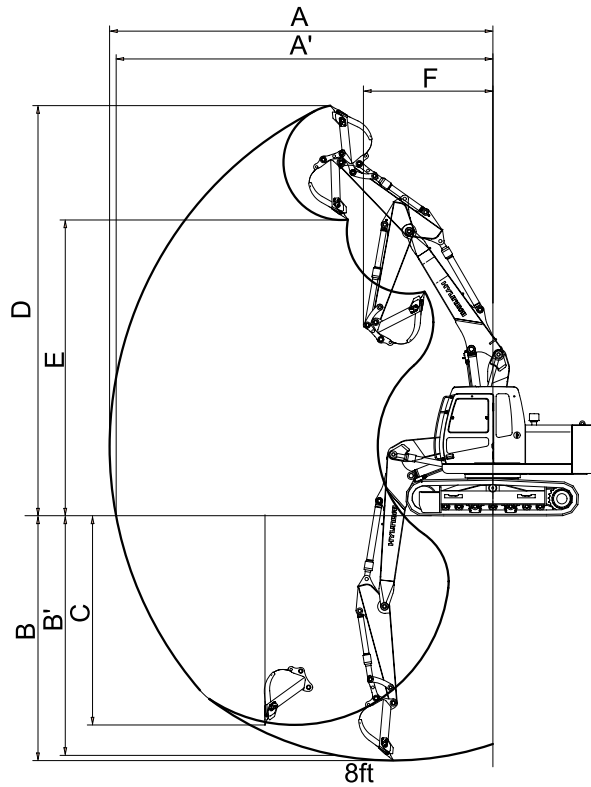

14072SP04A

Description		1.90m(6' 3") Arm	2.10m(6' 11") Arm	2.50m( 8' 2") Arm
Max digging reach	A	8140mm(26' 8")	8310mm(27' 3")	8720mm(28' 7")
Max digging reach on ground	A'	8000mm(26' 3")	8180mm(26'10")	8590mm(28' 2")
Max digging depth	B	5140mm(16'10")	5340mm(17' 6")	5740mm(18'10")
Max digging depth (8ft level)	B'	5020mm(16' 6")	5220mm(17' 2")	5630mm(18' 6")
Max vertical wall digging depth	C	4380mm(14' 4")	4560mm(15' 0")	5000mm(16' 5")
Max digging height	D	8770mm(28' 9")	8870mm(29' 1")	9230mm(30' 3")
Max dumping height	E	6280mm(20' 7")	6390mm(21' 0")	6740mm(22' 1")
Min swing radius	F	2660mm( 8' 9")	2800mm( 9' 2")	2670mm( 8' 9")
Bucket digging force	SAE	83.4[91]kN	83.4[91]kN	83.4[91]kN
		8500[9270]kgf	8500[9270]kgf	8500[9270]kgf
		18740[20440]lbf	18740[20440]lbf	18740[20440]lbf
	ISO	96.1[104.8]kN	96.1[104.8]kN	96.1[104.8]kN
		9800[10690]kgf	9800[10690]kgf	9800[10690]kgf
		21610[23570]lbf	21610[23570]lbf	21610[23570]lbf
Arm crowd force	SAE	74.5[81.3]kN	71.6[78.1]kN	61.8[67.4]kN
		7600[8290]kgf	7300[7960]kgf	6300[6870]kgf
		16760[18280]lbf	16090[17550]lbf	13890[15150]lbf
	ISO	78.5[85.6]kN	75.5[82.4]kN	64.7[70.6]kN
		8000[8730]kgf	7700[8400]kgf	6600[7200]kgf
		17640[19240]lbf	16980[18520]lbf	14550[15870]lbf

[ ] : Power boost

## 2) R140LCM-7

### (1) 4.6m(15' 1") boom

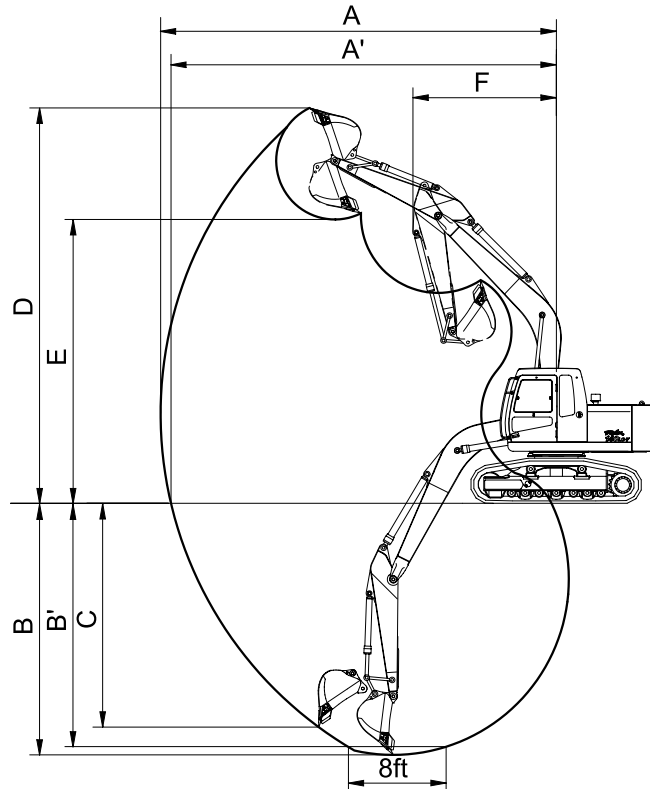

14072SP04M

Description		1.90m(6' 3") Arm	2.10m(6' 11") Arm	2.50m(10' 6") Arm	3.00m( 9' 10") Arm
Max digging reach	A	7750mm(25' 5")	7920mm(26' 0")	8340mm(27' 4")	8800mm(28'10")
Max digging reach on ground	A'	7540mm(24' 9")	7720mm(25' 4")	8130mm(26' 8")	8600mm(28' 3")
Max digging depth	B	4700mm(15' 5")	4900mm(16' 1")	5300mm(17' 5")	5800mm(19' 0")
Max digging depth (8ft level)	B'	4440mm(14' 7")	4650mm(15' 3")	5100mm(16' 9")	5620mm(18' 5")
Max vertical wall digging depth	C	4180mm(13' 9")	4310mm(14' 2")	4840mm(15'11")	5380mm(17' 8")
Max digging height	D	8340mm(27' 4")	8410mm(27' 7")	8740mm(28' 8")	9010mm(29' 7")
Max dumping height	E	5900mm(19' 4")	5980mm(19' 7")	6300mm(20' 8")	6560mm(21' 6")
Min swing radius	F	2620mm( 8' 7")	2680mm( 8'10")	2620mm( 8' 7")	2660mm( 8' 9")
Bucket digging force	SAE	83.4[91]kN	83.4[91]kN	83.4[91]kN	83.4[91]kN
		8500[9270]kgf	8500[9270]kgf	8500[9270]kgf	8500[9270]kgf
		18740[20440]lbf	18740[20440]lbf	18740[20440]lbf	18740[20440]lbf
	ISO	96.1[104.8]kN	96.1[104.8]kN	96.1[104.8]kN	96.1[104.8]kN
		9800[10690]kgf	9800[10690]kgf	9800[10690]kgf	9800[10690]kgf
		21610[23570]lbf	21610[23570]lbf	21610[23570]lbf	21610[23570]lbf
Arm crowd force	SAE	74.5[81.3]kN	71.6[78.1]kN	61.8[67.4]kN	53.9[59.0]kN
		7600[8290]kgf	7300[7960]kgf	6300[6870]kgf	5500[6020]kgf
		16760[18280]lbf	16090[17550]lbf	13890[15150]lbf	12130[13270]lbf
	ISO	78.5[85.6]kN	75.5[82.4]kN	64.7[70.6]kN	56.9[62.1]kN
		8000[8730]kgf	7700[8400]kgf	6600[7200]kgf	5800[6330]kgf
		17640[19240]lbf	16980[18520]lbf	14550[15870]lbf	12790[13950]lbf

[ ]: Power boost

#### 4. WEIGHT

Item	R140LC-7		R140LCD-7	
	kg	lb	kg	lb
Upperstructure assembly	5630	12420		
Main frame weld assembly	1100	2410		
Engine assembly	330	730		
Main pump assembly	70	120		
Main control valve assembly	80	180		
Swing motor assembly	130	260		
Hydraulic oil tank assembly	180	390		
Fuel tank assembly	140	300		
Counterweight	2200	4850		
Cab assembly	310	680		
Lower chassis assembly	5340	11760	6160	13580
Track frame weld assembly	1590	3510	1840	4060
Swing bearing	190	410		
Travel motor assembly	480	1060		
Turning joint	50	120		
Track recoil spring	210	460		
Idler	250	550		
Carrier roller	40	90		
Track roller	490	1080		
Track-chain assembly(600mm standard triple grouser shoe)	2030	4480		
Dozer blade assembly		-	550	1220
Front attachment assembly(4.6m boom, 2.5m arm, 0.58m³ PCSA heaped bucket)	2420	5330		
4.6m boom assembly	880	1940		
2.5m arm assembly	440	970		
0.58m³ PCSA heaped bucket	480	1060		
Boom cylinder assembly	260	570		
Arm cylinder assembly	160	350		
Bucket cylinder assembly	110	240		
Bucket control rod assembly	90	200		
Dozer blade cylinder assembly		-	50	120











Item	R140LCM-7	
	kg	lb
Upperstructure assembly	5630	12420
Main frame weld assembly	1100	2410
Engine assembly	330	730
Main pump assembly	70	120
Main control valve assembly	80	180
Swing motor assembly	130	260
Hydraulic oil tank assembly	180	390
Fuel tank assembly	140	300
Counterweight	2200	4850
Cab assembly	310	680
Lower chassis assembly	8700	19180
Track frame weld assembly	2180	4810
Swing bearing	190	410
Travel motor assembly	305	670
Turning joint	50	120
Tension cylinder assembly	280	620
Idler assembly	320	710
Carrier roller assembly	200	440
Track roller assembly	700	1540
Track-chain assembly(800mm standard triple grouser shoe)	2740	6040
Front attachment assembly(4.6m boom, 2.5m arm, 0.58m <sup>3</sup> PCSA heaped bucket)	2420	5330
4.6m boom assembly	880	1940
2.5m arm assembly	440	970
0.58m <sup>3</sup> PCSA heaped bucket	480	1060
Boom cylinder assembly	260	570
Arm cylinder assembly	160	350
Bucket cylinder assembly	110	240
Bucket control rod assembly	90	200

## 5. LIFTING CAPACITIES

### 1) R140LC-7











(1) 4.60m(15' 1") boom, 1.90m(6' 3") arm equipped with 0.58m<sup>3</sup>(PCSA heaped) bucket and 600mm (24") triple grouser shoe.

-  : Rating over-front
-  : Rating over-side or 360 degree











Load point height		Load radius								At max. reach		
		1.5m(5ft)		3.0m(10ft)		4.5m(15ft)		6.0m(20ft)		Capacity		Reach
												m(ft)
6.0m (20ft)	kg lb					*3160 *6970	*3160 *6970			*2910 *6420	2370 5220	5.95 (19.5)
4.5m (15ft)	kg lb					*3330 *7340	*3330 *7340			2840 6260	1770 3900	6.90 (22.6)
3.0m (10ft)	kg lb			*5940 *13100	*5940 *13100	*4140 *9130	3530 7780	3500 7720	2180 4810	2490 5490	1530 3370	7.37 (24.2)
1.5m (5ft)	kg lb			*8030 *17700	6070 13380	*5130 *11310	3280 7230	3390 7470	2080 4590	2400 5290	1460 3220	7.45 (24.4)
Ground Line	kg lb			*8200 *18080	5840 12870	5230 11530	3120 6880	3310 7300	2010 4430	2530 5580	1530 3370	7.17 (23.5)
-1.5m (-5ft)	kg lb	*6840 *15080	*6840 *15080	*8910 *19640	5850 12900	5170 11400	3070 6770			2980 6570	1820 4010	6.48 (21.3)
-3.0m (-10ft)	kg lb	*11210 *24710	*11210 *24710	*7580 *16710	6000 13230	*5000 *11020	3140 6920			*3380 *7450	2700 5950	5.15 (16.9)

- Note
1. Lifting capacity are based on SAE J1097 and ISO 10567.
  2. Lifting capacity of the ROBEX series does not exceed 75% of tipping load with the machine on firm, level ground or 87% of full hydraulic capacity.
  3. The load point is a hook located on the back of the bucket.
  4. \*indicates load limited by hydraulic capacity.

(2) 4.60m(15' 1") boom, 2.10m(6' 11") arm equipped with 0.58m<sup>3</sup>(PCSA heaped) bucket and 600mm (24") triple grouser shoe.













Load point height		Load radius								At max. reach		
		1.5m(5ft)		3.0m(10ft)		4.5m(15ft)		6.0m(20ft)		Capacity		Reach
												m(ft)
6.0m (20ft)	kg lb					*2930 *6460	*2930 *6460			*2780 *6130	2240 4940	6.17 (20.2)
4.5m (15ft)	kg lb					*3140 *6920	*3140 *6920	*2650 *5840	2260 4980	2720 6000	1700 3750	7.09 (23.3)
3.0m (10ft)	kg lb			*5510 *12150	*5510 *12150	*3950 *8710	3550 7830	*3390 *7470	2190 4830	2400 5290	1470 3240	7.54 (24.7)
1.5m (5ft)	kg lb			*8230 *18140	6130 13510	*4980 *10980	3290 7250	*3390 *7470	2080 4590	2310 5090	1400 3090	7.62 (25.0)
Ground Line	kg lb			*8240 *18560	5830 12850	5220 11510	3110 6860	3300 7280	2000 4410	2420 5340	1460 3220	7.35 (24.1)
-1.5m (-5ft)	kg lb	*6510 *14350	*6510 *14350	*9020 *19890	5810 12810	5140 11330	5140 11330	3270 7210	1970 4340	2820 6220	1720 3790	6.68 (21.9)
-3.0m (-10ft)	kg lb	*10480 *23100	*10480 *23100	*7840 *17280	5930 13070	*5180 *11420	5180 11420			*3400 *7500	2470 5450	5.41 (17.7)

(3) 4.60m(15' 1") boom, 2.50m(8' 2") arm equipped with 0.58m<sup>3</sup>(PCSA heaped) bucket and 600mm (24") triple grouser shoe.

Load point height		Load radius								At max. reach		
		1.5m(5ft)		3.0m(10ft)		4.5m(15ft)		6.0m(20ft)		Capacity		Reach
												m(ft)
6.0m (20ft)	kg lb									*2580 *5690	1940 4300	6.69 (21.9)
4.5m (15ft)	kg lb							*2710 *5970	2290 5050	2460 5420	1520 3350	7.53 (24.7)
3.0m (10ft)	kg lb			*4670 *10300	*4670 *10300	*3570 *7970	*3570 *7870	*3140 *6920	2210 4870	2190 4830	1330 2930	7.95 (26.1)
1.5m (5ft)	kg lb			*7530 *16600	6300 13890	*4670 *10300	3330 7340	3410 7520	2100 4630	2110 4650	1260 2780	8.03 (26.3)
Ground Line	kg lb			*8620 *19000	5870 12940	5240 11550	3120 6880	3300 7280	1990 4390	2200 4850	1310 2890	7.77 (25.5)
-1.5m (-5ft)	kg lb	*5750 *12680	*5950 *12680	*9180 *20240	5780 12740	5130 11310	3030 6680	3240 7140	1950 4300	2520 5560	1520 3350	7.15 (23.5)
-3.0m (-10ft)	kg lb	*8800 *19400	*8800 *19400	*8320 *18340	5860 12920	5150 11350	3050 6720			*3250 *7170	2060 4540	6.01 (19.7)
-4.5m (-15ft)	kg lb			*5950 *13120	*5950 *13120							

- Note
1. Lifting capacity are based on SAE J1097 and ISO 10567.
  2. Lifting capacity of the ROBEX series does not exceed 75% of tipping load with the machine on firm, level ground or 87% of full hydraulic capacity.
  3. The load point is a hook located on the back of the bucket.
  4. \*indicates load limited by hydraulic capacity.

(4) 4.60m(15' 1") boom, 3.00m(9' 10") arm equipped with 0.58m<sup>3</sup>(PCSA heaped) bucket and 600mm (24") triple grouser shoe.









Load point height		Load radius										At max. reach		
		1.5m(5ft)		3.0m(10ft)		4.5m(15ft)		6.0m(20ft)		7.5m(25ft)		Capacity		Reach
														kg
6.0m (20ft)	kg lb							*1810 *3990	*1810 *3990			*2320 *5110	1680 3700	7.25 (23.8)
4.5m (15ft)	kg lb							*2420 *5340	2330 5140			2200 4850	1340 2950	8.02 (26.3)
3.0m (10ft)	kg lb					*3050 *6720	*3050 *6720	*2790 *6150	2240 4940	*1580 *3480	1450 3200	1970 4340	1180 2600	8.41 (27.6)
1.5m (5ft)	kg lb			*6540 *14420	6520 14370	*4210 *9280	3390 7470	*3340 *7360	2110 4650	*2110 *4650	1400 3090	1910 4210	1120 2470	8.49 (27.9)
Ground Line	kg lb			*8610 *18980	5940 13100	*5230 *11530	3140 6920	3290 7250	1990 4390	*2000 *4410	1350 2980	1970 4340	1160 2560	8.25 (27.1)
-1.5m (-5ft)	kg lb	*5250 *11570	*5250 *11570	*9200 *20280	5750 12680	5110 11270	3000 6610	3210 7080	1910 4210			2220 4890	1310 2890	7.67 (25.2)
-3.0m (-10ft)	kg lb	*7680 *16930	*7680 *16930	*8740 *19270	5760 12700	5090 11220	2980 6570	3210 7080	1920 4230			2830 6240	1710 3770	6.64 (21.8)
-4.5m (-15ft)	kg lb	*11270 *24850	*11270 *24850	*7040 *15520	5950 13120	*4460 *9830	3100 6830							

- Note
1. Lifting capacity are based on SAE J1097 and ISO 10567.
  2. Lifting capacity of the ROBEX series does not exceed 75% of tipping load with the machine on firm, level ground or 87% of full hydraulic capacity.
  3. The load point is a hook located on the back of the bucket.
  4. \*indicates load limited by hydraulic capacity.

## 2) R140LC-7, 2-PIECE BOOM









(1) 4.90m(16' 1") 2-piece boom, 1.90m(6' 3") arm equipped with 0.58m<sup>3</sup>(PCSA heaped) bucket and 600mm(24") triple grouser shoe.

-  : Rating over-front
-  : Rating over-side or 360 degree













Load point height		Load radius						At max. reach		
		3.0m(10ft)		4.5m(15ft)		6.0m(20ft)		Capacity		Reach
										m(ft)
6.0m (20ft)	kg lb			*2730 *6020	*2730 *6020			*2620 *5780	2030 4480	6.45 (21.2)
4.5m (15ft)	kg lb			*3070 *6770	*3070 *6770	*2920 *6440	2230 4920	2550 5620	1550 3420	7.32 (24.0)
3.0m (10ft)	kg lb	*6070 *13380	*6070 *13380	*3930 *8660	3450 7610	*3230 *7120	2140 4720	2260 4980	1350 2980	7.76 (25.5)
1.5m (5ft)	kg lb			*4920 *10850	3170 6990	3350 7390	2020 4450	2180 4810	1290 2840	7.84 (25.7)
Ground Line	kg lb	*5350 *11790	*5350 *11790	5130 11310	3000 6610	3250 7170	1930 4250	2280 5030	1350 2980	7.57 (24.8)
-1.5m (-5ft)	kg lb	*8700 *19180	5680 12520	5080 11200	2960 6530	3230 7120	1910 4210	2650 5840	1580 3480	6.93 (22.7)
-3.0m (-10ft)	kg lb	*7700 *16980	5840 12870	5170 11400	3030 6680					

- Note
1. Lifting capacity are based on SAE J1097 and ISO 10567.
  2. Lifting capacity of the ROBEX series does not exceed 75% of tipping load with the machine on firm, level ground or 87% of full hydraulic capacity.
  3. The load point is a hook located on the back of the bucket.
  4. \*indicates load limited by hydraulic capacity.

(2) 4.90m(16' 1") 2-piece boom, 2.10m(6' 11") arm equipped with 0.58m<sup>3</sup>(PCSA heaped) bucket and 600mm(24") triple grouser shoe.

Load point height		Load radius						At max. reach		
		3.0m(10ft)		4.5m(15ft)		6.0m(20ft)		Capacity		Reach
										m(ft)
6.0m (20ft)	kg lb			*2530 *5580	*2530 *5580			*2520 *5560	1920 4230	6.67 (21.9)
4.5m (15ft)	kg lb			*2890 *6370	*2890 *6370	*2790 *6150	2250 4960	2440 5380	1490 3280	7.51 (24.6)
3.0m (10ft)	kg lb	*5620 *12390	*5620 *12390	*3750 *8270	3480 7670	*3120 *6880	2150 4740	2170 4780	1290 2840	7.93 (26.0)
1.5m (5ft)	kg lb			*4770 *10520	3180 7010	3350 7390	2020 4450	2100 4630	1230 2710	8.01 (26.3)
Ground Line	kg lb	*5630 *12410	5610 12370	5120 11290	2990 6590	3240 7140	1930 4250	2190 4830	1280 2820	7.76 (25.5)
-1.5m (-5ft)	kg lb	*8800 *19400	5630 12410	5050 11130	2930 6460	3210 7080	1890 4170	2510 5530	1490 3280	7.13 (23.4)
-3.0m (-10ft)	kg lb	*7910 *17440	5770 12720	5120 11290	2990 6590					



(3) 4.90m(16' 1") 2-piece boom, 2.50m(8' 2") arm equipped with 0.58m<sup>3</sup>(PCSA heaped) bucket and 600mm(24") triple grouser shoe.











Load point height		Load radius								At max. reach				
		1.5m(5ft)		3.0m(10ft)		4.5m(15ft)		6.0m(20ft)		7.5m(25ft)		Capacity		Reach
														m(ft)
6.0m (20ft)	kg lb							*2150 *4740	*2150 *4740			*2340 *5160	1680 3700	7.17 (23.5)
4.5m (15ft)	kg lb					*2520 *5560	*2520 *5560	*2510 *5530	2290 5050			2210 4870	1330 2930	7.95 (26.1)
3.0m (10ft)	kg lb			*4770 *10520	*4770 *10520	*3400 *7500	*3400 *7500	*2880 *6350	2180 4810	*1720 *3790	1410 3110	1990 4390	1170 2580	8.35 (27.4)
1.5m (5ft)	kg lb			*6780 *14950	6010 13250	*4480 *9880	3230 7120	3370 7430	2040 4500	2310 5090	1360 3000	1920 4230	1110 2450	8.42 (27.6)
Ground Line	kg lb			*5900 *13010	5640 12430	5140 11330	3000 6610	3240 7140	1920 4230	*2100 *4630	1320 2910	2000 4410	1160 2560	8.18 (26.8)
-1.5m (-5ft)	kg lb	*4660 *10270	*4660 *10270	*8160 *17990	5590 12320	5040 11110	2910 6420	3180 7010	1870 4120			2260 4980	1320 2910	7.59 (24.9)
-3.0m (-10ft)	kg lb			*8290 *18280	5690 12540	5060 11160	2940 6480	3220 7100	1900 4190					

- Note
1. Lifting capacity are based on SAE J1097 and ISO 10567.
  2. Lifting capacity of the ROBEX series does not exceed 75% of tipping load with the machine on firm, level ground or 87% of full hydraulic capacity.
  3. The load point is a hook located on the back of the bucket.
  4. \*indicates load limited by hydraulic capacity.

### 3) R140LCD-7











(1) 4.60m(15' 1") boom, 1.9m(6' 3") arm equipped with 0.58m<sup>3</sup>(PCSA heaped) bucket and 600mm (24") triple grouser shoe.

-  : Rating over-front
-  : Rating over-side or 360 degree











Load point height		Load radius								At max. reach		
		1.5m(5ft)		3.0m(10ft)		4.5m(15ft)		6.0m(20ft)		Capacity		Reach
												m(ft)
6.0m (20ft)	kg lb					*3160 *6970	*3160 *6970			*2910 *6420	2510 5530	5.95 (19.5)
4.5m (15ft)	kg lb					*3330 *7340	*3330 *7340			*3000 *6610	1890 4170	6.90 (22.6)
3.0m (10ft)	kg lb			*5940 *13100	*5940 *13100	*4140 *9130	3720 8200	*3520 *7760	2310 5090	2720 6000	1630 3590	7.37 (24.2)
1.5m (5ft)	kg lb			*8030 *17700	6410 14130	*5130 *11310	3470 7650	3690 8140	2220 4890	2620 5780	1560 3440	7.45 (24.4)
Ground Line	kg lb			*8200 *18080	6180 13620	5670 12500	3310 7300	3610 7960	2140 4720	2760 6080	1640 3620	7.17 (23.5)
-1.5m (-5ft)	kg lb	*6840 *15080	*6840 *15080	*8910 *19640	6190 13650	5620 12390	3260 7190			3250 7170	1940 4280	6.48 (21.3)
-3.0m (-10ft)	kg lb	*11210 *24710	*11210 *24710	*7580 *16710	6340 13980	*5000 *11020	3330 7340			*3380 *7450	2860 6310	5.15 (16.9)

- Note
1. Lifting capacity are based on SAE J1097 and ISO 10567.
  2. Lifting capacity of the ROBEX series does not exceed 75% of tipping load with the machine on firm, level ground or 87% of full hydraulic capacity.
  3. The load point is a hook located on the back of the bucket.
  4. \*indicates load limited by hydraulic capacity.

(2) 4.60m(15' 1") boom, 2.10m(6' 11") arm equipped with 0.58m<sup>3</sup>(PCSA heaped) bucket and 600mm (24") triple grouser shoe.













Load point height		Load radius								At max. reach		
		1.5m(5ft)		3.0m(10ft)		4.5m(15ft)		6.0m(20ft)		Capacity		Reach
												m(ft)
6.0m (20ft)	kg lb					*2930 *6460	*2930 *6460			*2780 *6130	2370 5220	6.17 (20.2)
4.5m (15ft)	kg lb					*3140 *6920	*3140 *6920	*2650 *5840	2390 5270	*2880 *6350	1810 3990	7.09 (23.3)
3.0m (10ft)	kg lb			*5510 *12150	*5510 *12150	*3950 *8710	3740 8250	*3390 *7470	2320 5110	2620 5780	1570 3460	7.54 (24.7)
1.5m (5ft)	kg lb			*8230 *18140	6470 14260	*4980 *10980	3480 7670	3690 8140	2220 4890	2530 5580	1500 3310	7.62 (25.0)
Ground Line	kg lb			*8420 *18560	6170 13600	5660 12480	3300 7280	3600 7940	2130 4700	2650 5840	1570 3460	7.35 (24.1)
-1.5m (-5ft)	kg lb	*6510 *14350	*6510 *14350	*9020 *19890	6150 13560	5590 12320	3230 7120	3570 7870	2110 4650	3080 6790	1830 4030	6.68 (21.9)
-3.0m (-10ft)	kg lb	*10480 *23100	*10480 *23100	*7840 *17280	6270 13820	*5180 *11420	3290 7250			*3400 *7500	2620 5780	5.41 (17.7)

(3) 4.60m(15' 1") boom, 2.50m(8' 2") arm equipped with 0.58m<sup>3</sup>(PCSA heaped) bucket and 600mm (24") triple grouser shoe.

Load point height		Load radius								At max. reach		
		1.5m(5ft)		3.0m(10ft)		4.5m(15ft)		6.0m(20ft)		Capacity		Reach
												m(ft)
6.0m (20ft)	kg lb									*2580 *5690	2060 4540	6.69 (21.9)
4.5m (15ft)	kg lb							*2710 *5970	2430 5360	*2670 *5890	1620 3570	7.53 (24.7)
3.0m (10ft)	kg lb			*4670 *10300	*4670 *10300	*3570 *7870	*3570 *7870	*3140 *6920	2340 5160	2400 5290	1420 3130	7.95 (26.1)
1.5m (5ft)	kg lb			*7530 *16600	6640 14640	*4670 *10300	3520 7760	*3620 *7980	2230 4920	2320 5110	1360 3000	8.03 (26.3)
Ground Line	kg lb			*8620 *19000	6210 13690	*5520 *12170	3310 7300	3590 7910	2130 4700	2420 5340	1410 3110	7.77 (25.5)
-1.5m (-5ft)	kg lb	*5750 *12680	*5750 *12680	*9180 *20240	6120 13490	5580 12300	3220 7100	3540 7800	2080 4590	2760 6080	1630 3590	7.15 (23.5)
-3.0m (-10ft)	kg lb	*8800 *19400	*8800 *19400	*8320 *18340	6200 13670	*5450 *12020	3240 7140			*3250 *7170	2190 4830	6.01 (19.7)
-4.5m (-15ft)	kg lb			*5950 *13120	*5950 *13120							

- Note
1. Lifting capacity are based on SAE J1097 and ISO 10567.
  2. Lifting capacity of the ROBEX series does not exceed 75% of tipping load with the machine on firm, level ground or 87% of full hydraulic capacity.
  3. The load point is a hook located on the back of the bucket.
  4. \*indicates load limited by hydraulic capacity.

(4) 4.60m(15' 1") boom, 3.00m(9' 10") arm equipped with 0.58m<sup>3</sup>(PCSA heaped) bucket and 600mm (24") triple grouser shoe.











Load point height		Load radius										At max. reach		
		1.5m(5ft)		3.0m(10ft)		4.5m(15ft)		6.0m(20ft)		7.5m(25ft)		Capacity		Reach
														kg
6.0m (20ft)	kg lb							*1810 *3990	*1810 *3990			*2320 *5110	1780 3920	7.25 (23.8)
4.5m (15ft)	kg lb							*2420 *5340	*2420 *5340			2400 5290	1430 3150	8.02 (26.3)
3.0m (10ft)	kg lb					*3050 *6720	*3050 *6720	*2790 *6150	2370 5220	*1580 *3480	1550 3420	2170 4780	1260 2780	8.41 (27.6)
1.5m (5ft)	kg lb			*6540 *14420	*6540 *14420	*4210 *9280	3580 7890	*3340 *7360	2240 4940	*2110 *4650	1500 3310	2100 4630	1210 2670	8.49 (27.9)
Ground Line	kg lb			*8610 *18980	6280 13850	*5230 *11530	3330 7340	3590 7910	2120 4670	*2000 *4410	1450 3200	2170 4780	1250 2760	8.25 (27.1)
-1.5m (-5ft)	kg lb	*5250 *11570	*5250 *11570	*9200 *20280	6090 13430	5560 12260	3200 7050	3510 7740	2050 4520			2440 5380	1410 3110	7.67 (25.2)
-3.0m (-10ft)	kg lb	*7680 *16930	*7680 *16930	*8740 *19270	6100 13450	5530 12190	3180 7010	3510 7740	2050 4520			3090 6810	1830 4030	6.64 (21.8)
-4.5m (-15ft)	kg lb	*11270 *24850	*11270 *24850	*7040 *15520	6290 13870	*4460 *9830	3290 7250							

- Note
1. Lifting capacity are based on SAE J1097 and ISO 10567.
  2. Lifting capacity of the ROBEX series does not exceed 75% of tipping load with the machine on firm, level ground or 87% of full hydraulic capacity.
  3. The load point is a hook located on the back of the bucket.
  4. \*indicates load limited by hydraulic capacity.

#### 4) R140LCM-7











(1) 4.60m(15' 1") boom, 1.90m(6' 3") arm equipped with 0.58m<sup>3</sup>(PCSA heaped) bucket and 800mm (32") triple grouser shoe.

-  : Rating over-front
-  : Rating over-side or 360 degree











Load point height		Load radius								At max. reach		
		1.5m(5ft)		3.0m(10ft)		4.5m(15ft)		6.0m(20ft)		Capacity		Reach
												m(ft)
6.0m (20ft)	kg lb									*2630 *5800	2230 4920	6.87 (22.5)
4.5m (15ft)	kg lb					*2880 *6350	*2880 *6350	*2890 *6370	2740 6040	*2730 *6020	1810 3990	7.63 (25.0)
3.0m (10ft)	kg lb			*5200 *11460	*5200 *11460	*3800 *8380	*3800 *8380	*3250 *7170	2650 5840	2580 5690	1630 3590	7.99 (26.2)
1.5m (5ft)	kg lb			*7960 *17550	7390 16290	*4880 *10760	3940 8690	*3740 *8250	2530 5580	2530 5580	1590 3510	8.01 (26.3)
Ground Line	kg lb	*3550 *7830	*3550 *7830	*8720 *19220	7030 15500	*5660 *12480	3750 8270	3890 8580	2440 5380	2670 5890	1670 3680	7.70 (25.3)
-1.5m (-5ft)	kg lb	*6180 *13620	*6180 *13620	*9150 *20170	6980 15390	*5870 *12940	3680 8110	3850 8490	2400 5290	3100 6830	1950 4300	7.00 (23.0)
-3.0m (-10ft)	kg lb	*9400 *20720	*9400 *20720	*8100 *17860	7090 15630	*5320 *11730	3720 8200			*3260 *7190	2700 5950	5.74 (18.8)

- Note
1. Lifting capacity are based on SAE J1097 and ISO 10567.
  2. Lifting capacity of the ROBEX series does not exceed 75% of tipping load with the machine on firm, level ground or 87% of full hydraulic capacity.
  3. The load point is a hook located on the back of the bucket.
  4. \*indicates load limited by hydraulic capacity.

(2) 4.60m(15' 1") boom, 2.10m(6' 11") arm equipped with 0.58m<sup>3</sup>(PCSA heaped) bucket and 800mm (32") triple grouser shoe.











Load point height		Load radius								At max. reach		
		1.5m(5ft)		3.0m(10ft)		4.5m(15ft)		6.0m(20ft)		Capacity		Reach
												m(ft)
6.0m (20ft)	kg lb									*2620 *5780	2220 4890	6.87 (22.5)
4.5m (15ft)	kg lb					*2870 *6330	*2870 *6330	*2880 *6350	2730 6020	*2720 *6000	1810 3990	7.63 (25.0)
3.0m (10ft)	kg lb			*5190 *11440	*5190 *11440	*3780 *8330	*3780 *8330	*3240 *7140	2640 5820	2580 5690	1620 3570	7.99 (26.2)
1.5m (5ft)	kg lb			*7950 *17530	7380 16270	*4870 *10740	3930 8660	*3730 *8220	2520 5560	2530 5580	1580 3480	8.01 (26.3)
Ground Line	kg lb	*3560 *7850	*3560 *7850	*8730 *19250	7020 15480	*5650 *12460	3740 8250	3870 8530	2430 5360	2670 5890	1660 3660	7.70 (25.3)
-1.5m (-5ft)	kg lb	*6190 *13650	*6190 *13650	*9130 *20130	6970 15370	*5860 *12920	3660 8070	3830 8440	2390 5270	3090 6810	1940 4280	7.00 (23.0)
-3.0m (-10ft)	kg lb	*9410 *20750	*9410 *20750	*8090 *17840	7070 15590	*5310 *11710	3700 8160			*3250 *7170	2700 5950	5.74 (18.8)

(3) 4.60m(15' 1") boom, 2.50m(8' 2") arm equipped with 0.58m<sup>3</sup>(PCSA heaped) bucket and 800mm (32") triple grouser shoe.

Load point height		Load radius								At max. reach		
		1.5m(5ft)		3.0m(10ft)		4.5m(15ft)		6.0m(20ft)		Capacity		Reach
												m(ft)
6.0m (20ft)	kg lb									*2600 *5730	2200 4850	6.87 (22.5)
4.5m (15ft)	kg lb					*2840 *6260	*2840 *6260	*2850 *6280	2710 5970	*2690 *5930	1790 3950	7.63 (25.0)
3.0m (10ft)	kg lb			*5160 *11380	*5160 *11380	*3750 *8270	*3750 *8270	*3210 *7080	2610 5750	2560 5640	1600 3530	7.99 (26.2)
1.5m (5ft)	kg lb			*7920 *17460	7350 16200	*4840 *10670	3710 8620	*3700 *8160	2500 5510	2510 5530	1560 3440	8.01 (26.3)
Ground Line	kg lb	*3580 *7890	*3580 *7890	*8750 *19290	6990 15410	*5620 *12390	3710 8180	3850 8490	2400 5290	2650 5840	1640 3620	7.70 (25.3)
-1.5m (-5ft)	kg lb	*6220 *13710	*6220 *13710	*9110 *20080	6940 15300	*5830 *12850	3640 8020	3810 8400	2370 5220	3070 6770	1920 4230	7.00 (23.0)
-3.0m (-10ft)	kg lb	*9430 *20790	*9430 *20790	*8060 *17770	7050 15540	*5280 *11640	3680 8110			*3230 *7120	2680 5910	5.74 (18.8)

- Note
1. Lifting capacity are based on SAE J1097 and ISO 10567.
  2. Lifting capacity of the ROBEX series does not exceed 75% of tipping load with the machine on firm, level ground or 87% of full hydraulic capacity.
  3. The load point is a hook located on the back of the bucket.
  4. \*indicates load limited by hydraulic capacity.

(4) 4.60m(15' 1") boom, 3.00m(9' 10") arm equipped with 0.58m<sup>3</sup>(PCSA heaped) bucket and 800mm (32") triple grouser shoe.

Load point height		Load radius								At max. reach		
		1.5m(5ft)		3.0m(10ft)		4.5m(15ft)		6.0m(20ft)		Capacity		Reach
												m(ft)
6.0m (20ft)	kg lb									*2550 *5620	2170 4780	6.87 (22.5)
4.5m (15ft)	kg lb					*2790 *6150	*2790 *6150	*2800 *6170	2670 5890	*2650 *5840	1750 3860	7.63 (25.0)
3.0m (10ft)	kg lb			*5100 *11240	*5100 *11240	*3700 *8160	*3700 *8160	*3160 *6970	2570 5670	2520 5560	1560 3440	7.99 (26.2)
1.5m (5ft)	kg lb			*7860 *17330	7300 16090	*4790 *10560	3860 8510	*3650 *8050	2450 5400	2470 5450	1520 3350	8.01 (26.3)
Ground Line	kg lb	*3630 *8000	*3630 *8000	*8780 *19360	6940 15300	*5560 *12260	3670 8090	3800 8380	2360 5200	2610 5750	1610 3550	7.70 (25.3)
-1.5m (-5ft)	kg lb	*6260 *13800	*6260 *13800	*9050 *19950	6880 15170	*5780 *12740	3590 7910	3760 8290	2320 5110	3040 6700	1890 4170	7.00 (23.0)
-3.0m (-10ft)	kg lb	*9470 *20880	*9470 *20880	*8000 *17640	6990 15410	*5220 *11510	3630 8000			*3190 *7030	2640 5820	5.74 (18.8)

- Note
1. Lifting capacity are based on SAE J1097 and ISO 10567.
  2. Lifting capacity of the ROBEX series does not exceed 75% of tipping load with the machine on firm, level ground or 87% of full hydraulic capacity.
  3. The load point is a hook located on the back of the bucket.
  4. \*indicates load limited by hydraulic capacity.

## 6. BUCKET SELECTION GUIDE

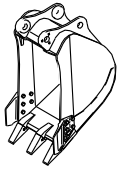
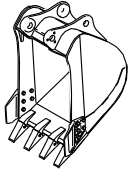
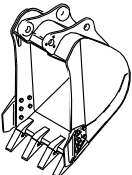
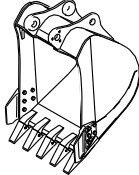
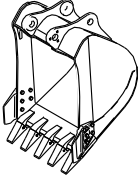
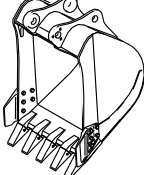
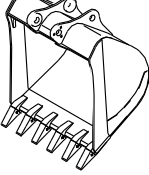

### 1) R140LC/LCD-7

#### (1) General bucket

						
0.22m <sup>3</sup> PCSA heaped bucket	0.4m <sup>3</sup> PCSA heaped bucket	0.46m <sup>3</sup> PCSA heaped bucket	0.51m <sup>3</sup> PCSA heaped bucket	0.58m <sup>3</sup> PCSA heaped bucket	0.63m <sup>3</sup> PCSA heaped bucket	0.70m <sup>3</sup> PCSA heaped bucket

Capacity		Width		Weight	Recommendation			
PCSA heaped	CECE heaped	Without side cutter	With side cutter		4.6m(15' 1") boom			
					1.9m arm (6' 3")	2.1m arm (6' 11")	2.5m arm (8' 2")	3.0m arm (9' 10")
0.23m <sup>3</sup> (0.30yd <sup>3</sup> )	0.2m <sup>3</sup> (0.26yd <sup>3</sup> )	520mm (20.5")	620mm (24.4")	335kg (740lb)				
0.40m <sup>3</sup> (0.52yd <sup>3</sup> )	0.35m <sup>3</sup> (0.46yd <sup>3</sup> )	760mm (29.9")	860mm (33.9")	410kg (900lb)				
0.46m <sup>3</sup> (0.60yd <sup>3</sup> )	0.4m <sup>3</sup> (0.52yd <sup>3</sup> )	850mm (33.5")	950mm (37.4")	435kg (960lb)				
0.52m <sup>3</sup> (0.68yd <sup>3</sup> )	0.45m <sup>3</sup> (0.59yd <sup>3</sup> )	935mm (36.8")	1035mm (40.8")	460kg (1010lb)				
0.58m <sup>3</sup> (0.76yd <sup>3</sup> )	0.5m <sup>3</sup> (0.65yd <sup>3</sup> )	1030mm (40.6")	1130mm (44.5")	480kg (1060lb)				
0.65m <sup>3</sup> (0.85yd <sup>3</sup> )	0.55m <sup>3</sup> (0.72yd <sup>3</sup> )	1110mm (43.7")	1210mm (47.6")	500kg (1100lb)				
0.71m <sup>3</sup> (0.93yd <sup>3</sup> )	0.6m <sup>3</sup> (0.78yd <sup>3</sup> )	1205mm (47.4")	-	540kg (1190lb)				

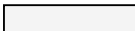
: Standard bucket

-  Applicable for materials with density of 2000kg/m<sup>3</sup> (3370lb/yd<sup>3</sup>) or less
-  Applicable for materials with density of 1600kg/m<sup>3</sup> (2700lb/yd<sup>3</sup>) or less
-  Applicable for materials with density of 1100kg/m<sup>3</sup> (1850lb/yd<sup>3</sup>) or less

## (2) Special bucket

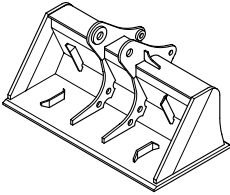
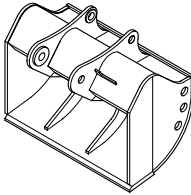
<p>Slope finishing bucket</p> 	<p>Ditch cleaning bucket</p> 
<p>≡0.55m<sup>3</sup> PCSA heaped bucket</p>	<p>0.45m<sup>3</sup> PCSA heaped bucket</p>

Capacity		Width		Weight	Recommendation			
PCSA heaped	CECE heaped	Without side cutter	With side cutter		4.6m (15' 1") boom			
					1.9m arm (6' 3")	2.1m arm (6' 11")	2.5m arm (8' 2")	3.0m arm (9' 10")
0.45m <sup>3</sup> (0.59yd <sup>3</sup> )	0.40m <sup>3</sup> (0.52yd <sup>3</sup> )	1520mm (59.8")	-	410kg (900lb)				
≡0.55m <sup>3</sup> (0.72yd <sup>3</sup> )	0.45m <sup>3</sup> (0.59yd <sup>3</sup> )	1800mm (70.9")	-	585kg (1290lb)				

≡ : Slope finishing bucket  
 : Ditch cleaning bucket

- Applicable for materials with density of 2000kgf/m<sup>3</sup> (3370lbf/yd<sup>3</sup>) or less
- Applicable for materials with density of 1600kgf/m<sup>3</sup> (2700lbf/yd<sup>3</sup>) or less
- Applicable for materials with density of 1100kgf/m<sup>3</sup> (1850lbf/yd<sup>3</sup>) or less

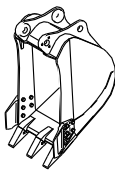
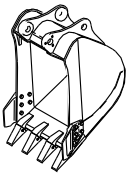
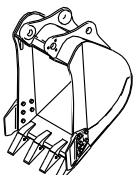
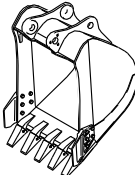
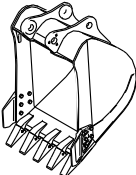
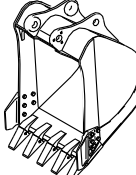
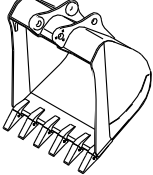

## 2) R140LC-7, 2-PIECE BOOM

### (1) General bucket

						
0.22m <sup>3</sup> PCSA heaped bucket	0.4m <sup>3</sup> PCSA heaped bucket	0.46m <sup>3</sup> PCSA heaped bucket	0.51m <sup>3</sup> PCSA heaped bucket	0.58m <sup>3</sup> PCSA heaped bucket	0.63m <sup>3</sup> PCSA heaped bucket	0.70m <sup>3</sup> PCSA heaped bucket

Capacity		Width		Weight	Recommendation		
PCSA heaped	CECE heaped	Without side cutter	With side cutter		4.9m(16' 1") 2-piece boom		
					1.9m arm (6' 3")	2.1m arm (6' 11")	2.5m arm (8' 2")
0.23m <sup>3</sup> (0.30yd <sup>3</sup> )	0.2m <sup>3</sup> (0.26yd <sup>3</sup> )	520mm (20.5")	620mm (24.4")	335kg (740lb)			
0.40m <sup>3</sup> (0.52yd <sup>3</sup> )	0.35m <sup>3</sup> (0.46yd <sup>3</sup> )	760mm (29.9")	860mm (33.9")	410kg (900lb)			
0.46m <sup>3</sup> (0.60yd <sup>3</sup> )	0.4m <sup>3</sup> (0.52yd <sup>3</sup> )	850mm (33.5")	950mm (37.4")	435kg (960lb)			
0.52m <sup>3</sup> (0.68yd <sup>3</sup> )	0.45m <sup>3</sup> (0.59yd <sup>3</sup> )	935mm (36.8")	1035mm (40.8")	460kg (1010lb)			
0.58m <sup>3</sup> (0.76yd <sup>3</sup> )	0.5m <sup>3</sup> (0.65yd <sup>3</sup> )	1030mm (40.6")	1130mm (44.5")	480kg (1060lb)			
0.65m <sup>3</sup> (0.85yd <sup>3</sup> )	0.55m <sup>3</sup> (0.72yd <sup>3</sup> )	1110mm (43.7")	1210mm (47.6")	500kg (1100lb)			
0.71m <sup>3</sup> (0.93yd <sup>3</sup> )	0.6m <sup>3</sup> (0.78yd <sup>3</sup> )	1205mm (47.4")	-	540kg (1190lb)			

: Standard bucket

-  Applicable for materials with density of 2000kg/m<sup>3</sup> (3370lb/yd<sup>3</sup>) or less
-  Applicable for materials with density of 1600kg/m<sup>3</sup> (2700lb/yd<sup>3</sup>) or less
-  Applicable for materials with density of 1100kg/m<sup>3</sup> (1850lb/yd<sup>3</sup>) or less

## (2) Special bucket

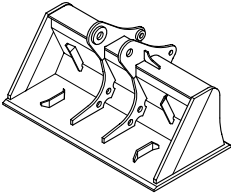
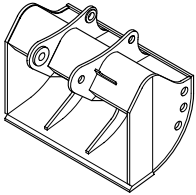
<p>Slope finishing bucket</p> 	<p>Ditch cleaning bucket</p> 
<p>≡0.55m<sup>3</sup> PCSA heaped bucket</p>	<p>0.45m<sup>3</sup> PCSA heaped bucket</p>

Capacity		Width		Weight	Recommendation		
					4.9m (16' 1") 2-piece boom		
PCSA heaped	CECE heaped	Without side cutter	With side cutter		1.9m arm (6' 3")	2.1m arm (6' 11")	2.5m arm (8' 2")
0.45m <sup>3</sup> (0.59yd <sup>3</sup> )	0.40m <sup>3</sup> (0.52yd <sup>3</sup> )	1520mm (59.8")	-	410kg (900lb)			
≡0.55m <sup>3</sup> (0.72yd <sup>3</sup> )	0.45m <sup>3</sup> (0.59yd <sup>3</sup> )	1800mm (70.9")	-	585kg (1290lb)			

≡ : Slope finishing bucket  
 : Ditch cleaning bucket

- Applicable for materials with density of 2000kgf/m<sup>3</sup> (3370lbf/yd<sup>3</sup>) or less
- Applicable for materials with density of 1600kgf/m<sup>3</sup> (2700lbf/yd<sup>3</sup>) or less
- Applicable for materials with density of 1100kgf/m<sup>3</sup> (1850lbf/yd<sup>3</sup>) or less

### 3) R140LCM-7

#### (1) General bucket

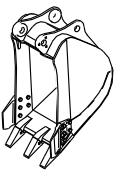
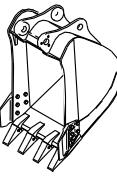
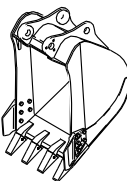
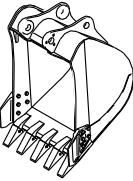
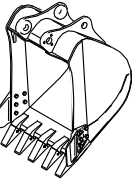
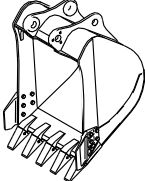
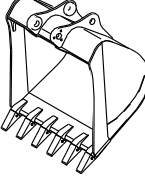
						
0.22m³ PCSA heaped bucket	0.4m³ PCSA heaped bucket	0.46m³ PCSA heaped bucket	0.51m³ PCSA heaped bucket	0.58m³ PCSA heaped bucket	0.63m³ PCSA heaped bucket	0.70m³ PCSA heaped bucket

Capacity		Width		Weight	Recommendation 4.6m(15' 1") boom			
PCSA heaped	CECE heaped	Without side cutter	With side cutter		1.9m arm (6' 3")	2.1m arm (6' 11")	2.5m arm (8' 2")	3.0m arm (9' 10")
0.23m³ (0.30yd³)	0.2m³ (0.26yd³)	520mm (20.5")	620mm (24.4")	335kg (740lb)				
0.40m³ (0.52yd³)	0.35m³ (0.46yd³)	760mm (29.9")	860mm (33.9")	410kg (900lb)				
0.46m³ (0.60yd³)	0.4m³ (0.52yd³)	850mm (33.5")	950mm (37.4")	435kg (960lb)				
0.52m³ (0.68yd³)	0.45m³ (0.59yd³)	935mm (36.8")	1035mm (40.8")	460kg (1010lb)				
0.58m³ (0.76yd³)	0.5m³ (0.65yd³)	1030mm (40.6")	1130mm (44.5")	480kg (1060lb)				
0.65m³ (0.85yd³)	0.55m³ (0.72yd³)	1110mm (43.7")	1210mm (47.6")	500kg (1100lb)				
0.71m³ (0.93yd³)	0.6m³ (0.78yd³)	1205mm (47.4")	-	540kg (1190lb)				

: Standard bucket

- Applicable for materials with density of 2000kg/m³ (3370lb/yd³) or less
- Applicable for materials with density of 1600kg/m³ (2700lb/yd³) or less
- Applicable for materials with density of 1100kg/m³ (1850lb/yd³) or less

**(2) Special bucket**

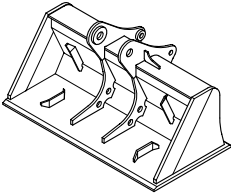
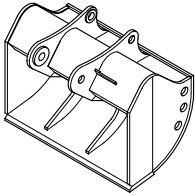
<p>Slope finishing bucket</p> 	<p>Ditch cleaning bucket</p> 
<p>≡0.55m<sup>3</sup> PCSA heaped bucket</p>	<p>0.45m<sup>3</sup> PCSA heaped bucket</p>

Capacity		Width		Weight	Recommendation		
					4.9m (16' 1") 2piece boom		
PCSA heaped	CECE heaped	Without side cutter	With side cutter		1.9m arm (6' 3")	2.1m arm (6' 11")	2.5m arm (8' 2")
0.45m <sup>3</sup> (0.59yd <sup>3</sup> )	0.40m <sup>3</sup> (0.52yd <sup>3</sup> )	1520mm (59.8")	-	410kg (900lb)			
≡0.55m <sup>3</sup> (0.72yd <sup>3</sup> )	0.45m <sup>3</sup> (0.59yd <sup>3</sup> )	1800mm (70.9")	-	585kg (1290lb)			

≡ : Slope finishing bucket  
 : Ditch cleaning bucket

- Applicable for materials with density of 2000kgf/m<sup>3</sup> (3370lbf/yd<sup>3</sup>) or less
- Applicable for materials with density of 1600kgf/m<sup>3</sup> (2700lbf/yd<sup>3</sup>) or less
- Applicable for materials with density of 1100kgf/m<sup>3</sup> (1850lbf/yd<sup>3</sup>) or less

## 7. UNDERCARRIAGE

### 1) TRACKS

X-leg type center frame is integrally welded with reinforced box-section track frames. The design includes dry tracks, lubricated rollers, idlers, sprockets, hydraulic track adjusters with shock absorbing springs and assembled track-type tractor shoes with triple grousers.

### 2) TYPES OF SHOES

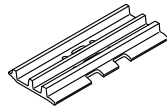
Model	Shapes		Triple grouser		
					
R140LC-7	Shoe width	mm(in)	500(20)	600(24)	700(28)
	Operating weight	kg(lb)	13770(30360)	13980(30860)	14190(31290)
	Ground pressure	kgf/cm <sup>2</sup> (psi)	0.43(6.11)	0.36(5.12)	0.32(4.55)
	Overall width	mm(ft-in)	2500(8' 2")	2600(8' 6")	2700(8' 10")
R140LCD-7	Shoe width	mm(in)	500(20)	600(24)	-
	Operating weight	kg(lb)	14590(32160)	14800(32630)	-
	Ground pressure	kgf/cm <sup>2</sup> (psi)	0.45(6.40)	0.38(5.40)	-
	Overall width	mm(ft-in)	2500(8' 2")	2600(8' 6")	-
R140LCM-7	Shoe width	mm(in)	800(32)	-	-
	Operating weight	kg(lb)	16880(37210)	-	-
	Ground pressure	kgf/cm <sup>2</sup> (psi)	0.32(4.55)	-	-
	Overall width	mm(ft-in)	2840(9' 4")	-	-

: Standard

### 3) NUMBER OF ROLLERS AND SHOES ON EACH SIDE

Item	Quantity	
	R140LC/LCD-7	R140LCM-7
Carrier rollers	1EA	2EA
Track rollers	7EA	7EA
Track shoes	46EA	47EA

### 4) SELECTION OF TRACK SHOE

Suitable track shoes should be selected according to operating conditions.

#### Method of selecting shoes

Confirm the category from the list of applications in **table 2**, then use **table 1** to select the shoe. Wide shoes (Categories B and C) have limitations on applications. Before using wide shoes, check the precautions, then investigate and study the operating conditions to confirm if these shoes are suitable. Select the narrowest shoe possible to meet the required flotation and ground pressure. Application of wider shoes than recommendations will cause unexpected problem such as bending of shoes, crack of link, breakage of pin, loosening of shoe bolts and the other various problems.

**Table 1**

Track shoe	Specification	Category
600mm triple grouser	Standard	A
500mm triple grouser	Option	A
700mm triple grouser	Option	B
800mm triple grouser	R140LCM-7 ONLY	B

**Table 2**

Category	Applications	Precautions
A	Rocky ground, river beds, normal soil	<ul style="list-style-type: none"> <li>· Travel at low speed on rough ground with large obstacles such as boulders or fallen trees</li> </ul>
B	Normal soil, soft ground	<ul style="list-style-type: none"> <li>· These shoes cannot be used on rough ground with large obstacles such as boulders or fallen trees</li> <li>· Travel at high speed only on flat ground</li> <li>· Travel slowly at low speed if it is impossible to avoid going over obstacles</li> </ul>

## 8. SPECIFICATIONS FOR MAJOR COMPONENTS

### 1) ENGINE

Item	Specification
Model	Cummins B3.9-C *4BTAA
Type	4-cycle turbocharged diesel engine *Charge air cooled
Cooling method	Water cooling
Number of cylinders and arrangement	4 cylinders, in-line
Firing order	1-3-4-2
Combustion chamber type	Direct injection type
Cylinder bore x stroke	102 x 120mm
Piston displacement	3900cc(238cu in)
Compression ratio	17.8 : 1 *18 : 1
Rated gross horse power(SAE J1995)	107Hp (80kW) at 2100rpm
	*115Hp (86kW) at 2100rpm
Maximum torque	46.2kgf · m(334lbf · ft) at 1500rpm
	*47.7kgf · m(345lbf · ft) at 1500rpm
Engine oil quantity	9.5 (2.5U.S. gal) *15.3 (4.0U.S. gal)
Dry weight	329kg(726lb) *317kg
High idling speed	2350 ± 50rpm
Low idling speed	950 ± 100rpm *850 ± 100rpm
Rated fuel consumption	167.8g/Hp · hr at 2100rpm *162g/Hp · hr at 2100rpm
Starting motor	Nippon denso(24V-4.5kW)
Alternator	Delco Remy 24V-50A
Battery	2 x 12V x 80Ah

\* : TIER II

### 2) MAIN PUMP

Item	Specification
Type	Variable displacement tandem axis piston pumps
Capacity	2 x 62cc/rev
Maximum pressure	330kgf/cm <sup>2</sup> (4690psi)[360kgf/cm <sup>2</sup> (5120psi)]
Rated oil flow	2 x 130 /min (34.3U.S. gpm/ 28.6U.K. gpm)
Rated speed	2100rpm

[ ]: Power boost

### 3) GEAR PUMP

Item	Specification
Type	Fixed displacement gear pump single stage
Capacity	15cc/rev
Maximum pressure	35kgf/cm <sup>2</sup> (500psi)
Rated oil flow	31.5 /min(8.3U.S. gpm/7.0U.K. gpm)

### 4) MAIN CONTROL VALVE

Item	Specification
Type	10 spools
Operating method	Hydraulic pilot system
Main relief valve pressure	330kgf/cm <sup>2</sup> (4690psi) [360kgf/cm <sup>2</sup> (5120psi)]
Overload relief valve pressure	380kgf/cm <sup>2</sup> (5540psi)

[ ]: Power boost

### 5) SWING MOTOR

Item	Specification
Type	Fixed displacement axial piston motor
Capacity	64.3cc/rev
Relief pressure	240kgf/cm <sup>2</sup> (3410psi)
Braking system	Automatic, spring applied hydraulic released
Braking torque	25kgf · m(180lb · ft)
Brake release pressure	30~50kgf/cm <sup>2</sup> (426~710psi)
Reduction gear type	2 - stage planetary
Swing speed	13.6rpm

### 6) TRAVEL MOTOR

Item	Specification
Type	Variable displacement axial piston motor
Relief pressure	330kgf/cm <sup>2</sup> (4620psi)
Capacity(max / min)	90.3/56cc/rev
Reduction gear type	2-stage planetary
Braking system	Automatic, spring applied hydraulic released
Brake release pressure	6.0kgf/cm <sup>2</sup> (85psi)
Braking torque	40.6kgf · m(294lb · ft)

## 7) REMOTE CONTROL VALVE

Item		Specification
Type		Pressure reducing type
Operating pressure	Minimum	6.5kgf/cm <sup>2</sup> (92psi)
	Maximum	26kgf/cm <sup>2</sup> (370psi)
Single operation stroke	Lever	61mm(2.4in)
	Pedal	123mm(4.84in)

## 8) CYLINDER

Item		Specification
Boom cylinder	Bore dia × Rod dia × Stroke	Ø105 × Ø75 × 1075mm
	Cushion	Extend only
Arm cylinder	Bore dia × Rod dia × Stroke	Ø115 × Ø80 × 1188mm
	Cushion	Extend and retract
Bucket cylinder	Bore dia × Rod dia × Stroke	Ø100 × Ø70 × 855mm
	Cushion	Extend only
Dozer cylinder(Optional)	Bore dia × Rod dia × Stroke	Ø100 × Ø70 × 270mm
	Cushion	-

**Discoloration of cylinder rod can occur when the friction reduction additive of lubrication oil spreads on the rod surface.**

**Discoloration does not cause any harmful effect on the cylinder performance.**

## 9) SHOE

Item		Width	Ground pressure	Link quantity	Overall width
R140LC-7	Standard	600mm(24")	0.36kgf/cm <sup>2</sup> (5.12psi)	46	2600mm( 8' 6")
	Option	500mm(20")	0.43kgf/cm <sup>2</sup> (6.11psi)	46	2500mm( 8' 2")
		700mm(28")	0.32kgf/cm <sup>2</sup> (4.55psi)	46	2700mm( 8' 10")
R140LCD-7	Option	500mm(20")	0.45kgf/cm <sup>2</sup> (6.40psi)	46	2500mm( 8' 2")
		600mm(24")	0.38kgf/cm <sup>2</sup> (5.40psi)	46	2600mm( 8' 6")
R140LCM-7	Option	800mm(32")	0.32kgf/cm <sup>2</sup> (4.55psi)	47	2840mm( 9' 4")

## 10) BUCKET

Item		Capacity		Tooth quantity	Width	
		PCSA heaped	CECE heaped		Without side cutter	With side cutter
R140LC-7	Standard	0.58m <sup>3</sup> (0.76yd <sup>3</sup> )	0.50m <sup>3</sup> (0.65yd <sup>3</sup> )	5	1030mm(40.6")	1130mm(44.5")
	Option	0.23m <sup>3</sup> (0.30yd <sup>3</sup> )	0.20m <sup>3</sup> (0.26yd <sup>3</sup> )	3	520mm(20.5")	620mm(24.4")
		0.40m <sup>3</sup> (0.52yd <sup>3</sup> )	0.35m <sup>3</sup> (0.46yd <sup>3</sup> )	4	760mm(29.9")	860mm(33.9")
		0.46m <sup>3</sup> (0.60yd <sup>3</sup> )	0.40m <sup>3</sup> (0.52yd <sup>3</sup> )	4	850mm(33.5")	950mm(37.4")
		0.52m <sup>3</sup> (0.68yd <sup>3</sup> )	0.45m <sup>3</sup> (0.59yd <sup>3</sup> )	5	935mm(36.8")	1035mm(40.8")
		0.65m <sup>3</sup> (0.85yd <sup>3</sup> )	0.55m <sup>3</sup> (0.72yd <sup>3</sup> )	5	1110mm(43.7")	1210mm(47.6")
		0.71m <sup>3</sup> (0.93yd <sup>3</sup> )	0.60m <sup>3</sup> (0.78yd <sup>3</sup> )	6	1205mm(47.4")	-
		0.45m <sup>3</sup> (0.59yd <sup>3</sup> )	0.40m <sup>3</sup> (0.52yd <sup>3</sup> )	-	1520mm(59.8")	-
		0.55m <sup>3</sup> (0.72yd <sup>3</sup> )	0.45m <sup>3</sup> (0.59yd <sup>3</sup> )	-	1800mm(70.9")	-

☞ : Slope finishing bucket

☞ : Ditch cleaning bucket

## 9. RECOMMENDED OILS

Use only oils listed below or equivalent.

Do not mix different brand oil.

Service point	Kind of fluid	Capacity (U.S. gal)	Ambient temperature °C (°F)						
			-20 (-4)	-10 (14)	0 (32)	10 (50)	20 (68)	30 (86)	40 (104)
Engine oil pan	Engine oil	9.5(2.5) 15.3(4.0) TIER II	SAE 30						
			SAE 10W						
			SAE 10W-30						
			SAE 15W-40						
Swing drive	Grease	0.35(0.1)	NLGI NO.1						
			NLGI NO.2						
Swing drive	Gear oil	2.5(0.7)	SAE 85W-140						
Final drive		3.0 × 2 (0.8 × 2)							
Hydraulic tank	Hydraulic oil	Tank; 124(32.8) System; 210(55.5)	ISO VG 32						
			ISO VG 46						
			ISO VG 68						
Fuel tank	Diesel fuel	270(71.0)	ASTM D975 NO.1						
			ASTM D975 NO.2						
Fitting (Grease nipple)	Grease	As required	NLGI NO.1						
			NLGI NO.2						
Radiator (Reservoir tank)	Mixture of antifreeze and water 50 : 50	21.8(5.8)	Ethylene glycol base permanent type						

**SAE** : Society of Automotive Engineers

**API** : American Petroleum Institute

**ISO** : International Organization for Standardization

**NLGI** : National Lubricating Grease Institute

**ASTM** : American Society of Testing and Material