

GROUP 3 TESTS AND ADJUSTMENTS

1. PARKING BRAKE PERFORMANCE

1) MEASUREMENT CONDITION

- (1) Tire inflation pressure : Specified pressure
- (2) Road surface : Flat, dry, paved surface with 1/5 (11°20') gradient.
- (3) Machine : In operating condition

Item	Standard value
Parking brake performance	Keep machine on 20% (11°20') gradient

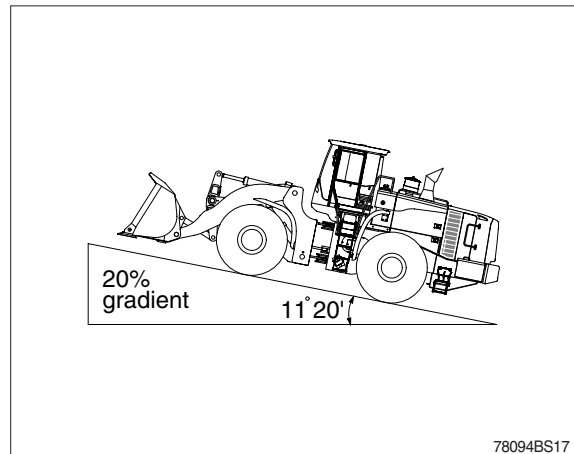

2) MEASURING PROCEDURE

- (1) Start the engine and drive the machine straight up a 1/5 gradient with the bucket unloaded.
- (2) Depress the service brake, place the gear selector lever in neutral, then stop the engine.
- (3) Turn the parking brake switch ON, then slowly release the service brake pedal and the machine must be kept stopped.
 - ※ The measurement must be made with the machine facing either up or down the slope.

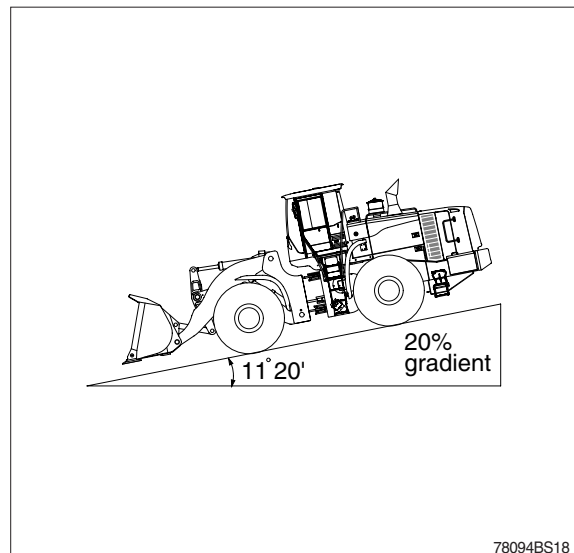

2. ADJUSTMENT OF PARKING BRAKE

- (1) External brake inspection
 - Inspect for wear of brake pad
- (2) Refer to the PARKING BRAKE SYSTEM on the page 4-21.

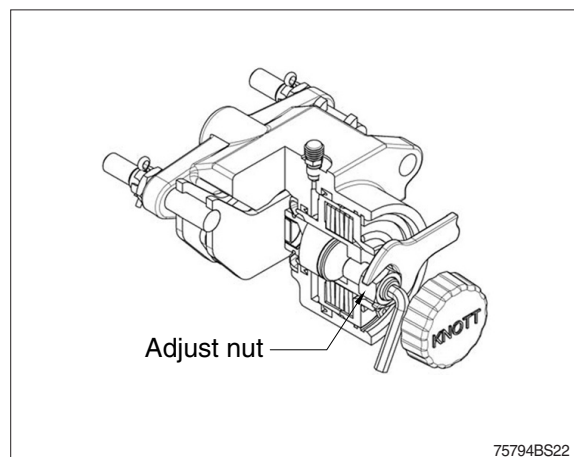

3. HYDRAULIC BRAKE BLEEDING PROCEDURE

▲ Escaping fluid under pressure can penetrate the skin causing serious injury. Avoid the hazard by relieving pressure before disconnecting hydraulic or other lines. Tighten all connections before applying pressure.

Search for leaks with a piece of cardboard. Protect hands and body from high pressure fluids.

※ If an accident occurs, see a doctor immediately. Any fluid injected into the skin must be surgically removed within a few hours or gangrene may result.

Doctors unfamiliar with this type of injury should reference a knowledgeable medical source.

Two people are required to bleed brake system oil, one to operate brake valve and other to open and close bleed screws.

- 1) Install frame locking bar. Engage parking brake.
- 2) Put a clear plastic tube on bleed screw to route low to hydraulic oil tank filler tube or container (A).
- 3) Start engine and run at low idle.
- 4) Push and hold brake pedal down until brake bleeding procedure is complete.
 - ※ If bubbles continue for more than 2 minutes, stop bleeding procedure. Check for and correct problem, then continue.
- 5) Open on bleed screw on differential and axle assembly until hydraulic oil starts to flow. Close bleed screw when oil is free of air. Release brake pedal.
- 6) Repeat steps 1)~5) for each bleed screw.
- 7) Push either brake pedal and hold down.
- 8) Check hydraulic oil level.

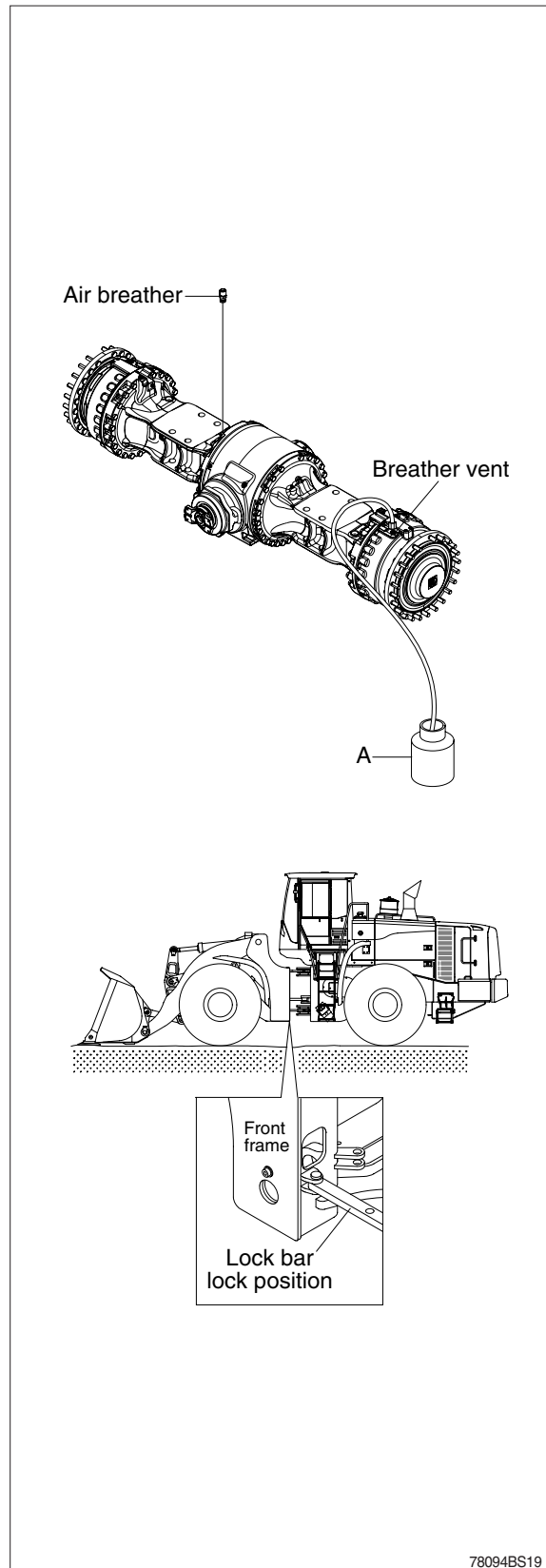

78094BS19