

GROUP 3 TESTS AND ADJUSTMENTS

1. HYDRAULIC OIL CLEAN UP PROCEDURE USING PORTABLE FILTER CADDY

※ **Service equipment and tool.**

- Portable filter caddy
- Two 3658mm(12ft) × 1" I.D. 100R1 hoses with 3/4 M NPT ends
- Quick disconnect fittings
- Discharge wand
- Various size fittings and hoses

※ **Brake system uses oil from hydraulic oil tank. Flush all lines in the steering system.**

Disassemble and clean major components for steering system.

Steering components may fail if steering system is not cleaned after hydraulic oil tank contamination.

1) If hydraulic system is contaminated due to a major component failure, remove and disassemble steering cylinders to clean debris from cylinders.

2) Install a new return filter element. Clean filter housing before installing new element.

※ **For a failure that creates a lot of debris, remove access cover from hydraulic oil tank. Drain and clean hydraulic oil tank of fill the specified oil to hydraulic oil tank through upper cover.**

3) To minimize oil loss, pull a vacuum in hydraulic oil tank using a vacuum pump. Connect filter caddy suction line to drain port at bottom of hydraulic oil tank using connector. Check to be sure debris has not closed drain port.

4) Put filter caddy discharge line into hydraulic oil tank filter hole so end is as far away from drain port as possible to obtain a through cleaning of oil.

5) Start the filter caddy. Check to be sure oil is flowing through the filters.

Operate filter caddy approximately 10 minutes so oil in hydraulic oil tank is circulated through filter a minimum of four times.

※ **Hydraulic oil tank capacity 210 l (55.5 U.S. gal).**

Leave filter caddy operating for the next steps.

6) Start the engine and run it at high idle.

※ **For the most effective results, cleaning procedure must start with the smallest capacity circuit then proceed to the next largest capacity circuit.**

7) Operate all functions, one at a time, through a complete cycle in the following order: clam, steering, bucket, and boom. Also include all auxiliary hydraulic functions.

Repeat procedure until the total system capacity has circulated through filter caddy seven times, approximately 30 minutes.

Each function must go through a minimum of three complete cycles for a thorough cleaning for oil.

※ **Filtering time for machines with auxiliary hydraulic functions must be increased because system capacity is larger.**

8) Stop the engine. Remove the filter caddy.

9) Install a new return filter element.

10) Check oil level in hydraulic oil tank ; Add oil if necessary.

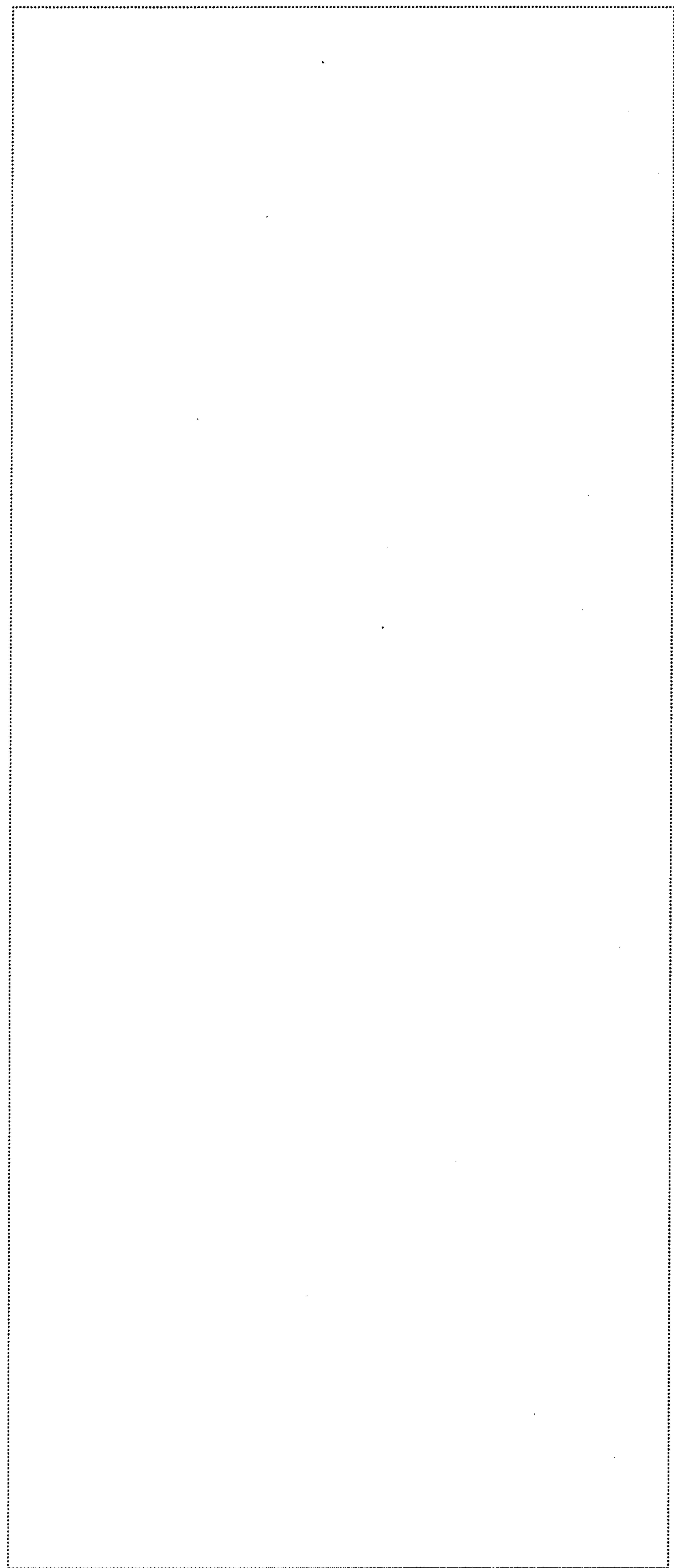

2. TEST TOOLS

1) CLAMP-ON ELECTRONIC TACHOMETER INSTALLATION

- Service equipment and tools
Tachometer

A : Clamp on tachometer.

Remove paint using emery cloth and connect to a straight section of injection line within 100mm(4in) of pump. Finger tighten only-do not over tighten.

B : Black clip(-). Connect to main frame.

C : Red clip(+). Connect to transducer.

D : Tachometer readout. Install cable.

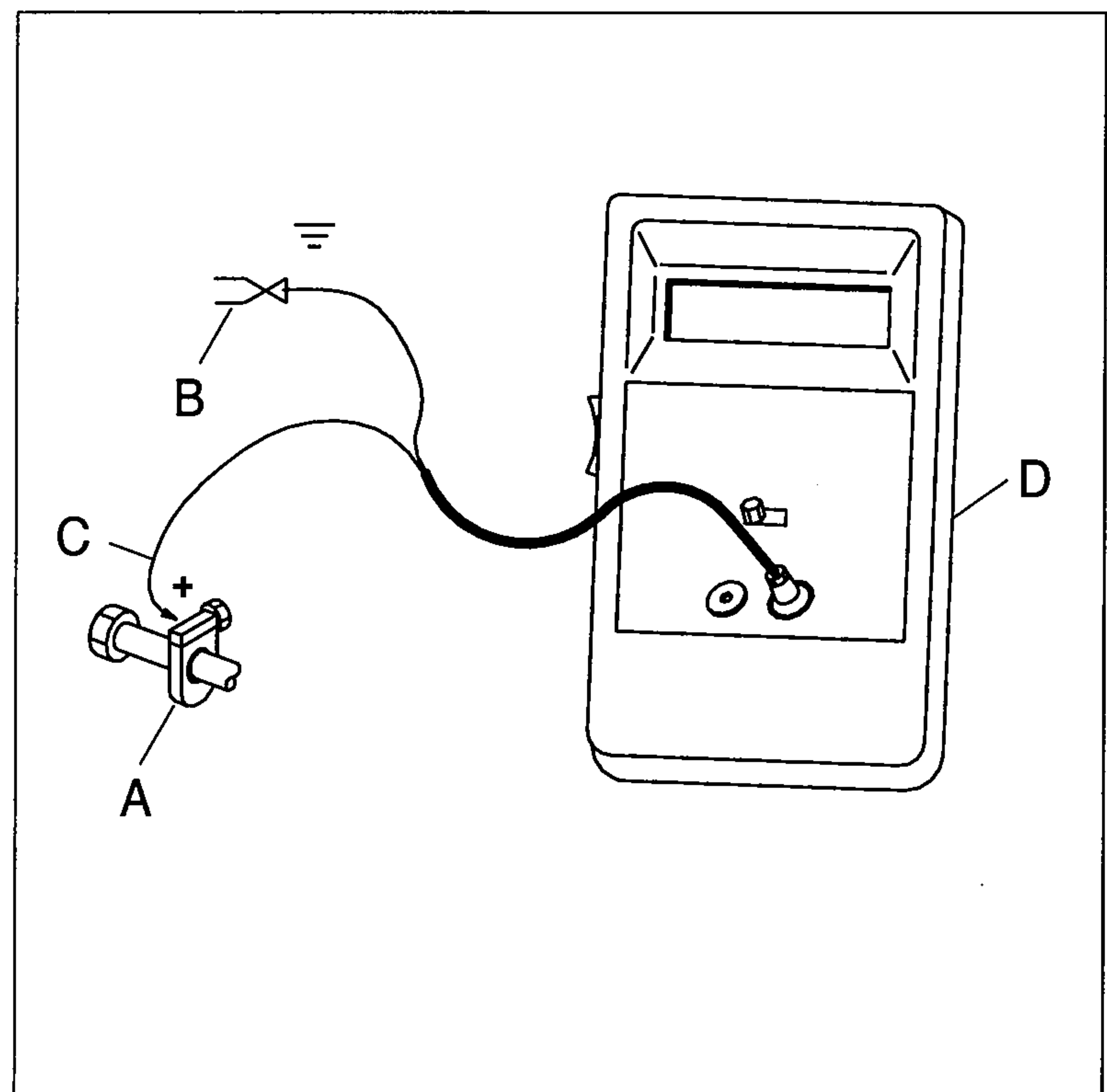

2) DIGITAL THERMOMETER INSTALLATION

- Service equipment and tools
Digital thermometer

A : Temperature probe.

Fasten to a bare metal line using a tie band. Wrap with shop towel.

B : Cable.

C : Digital thermometer.

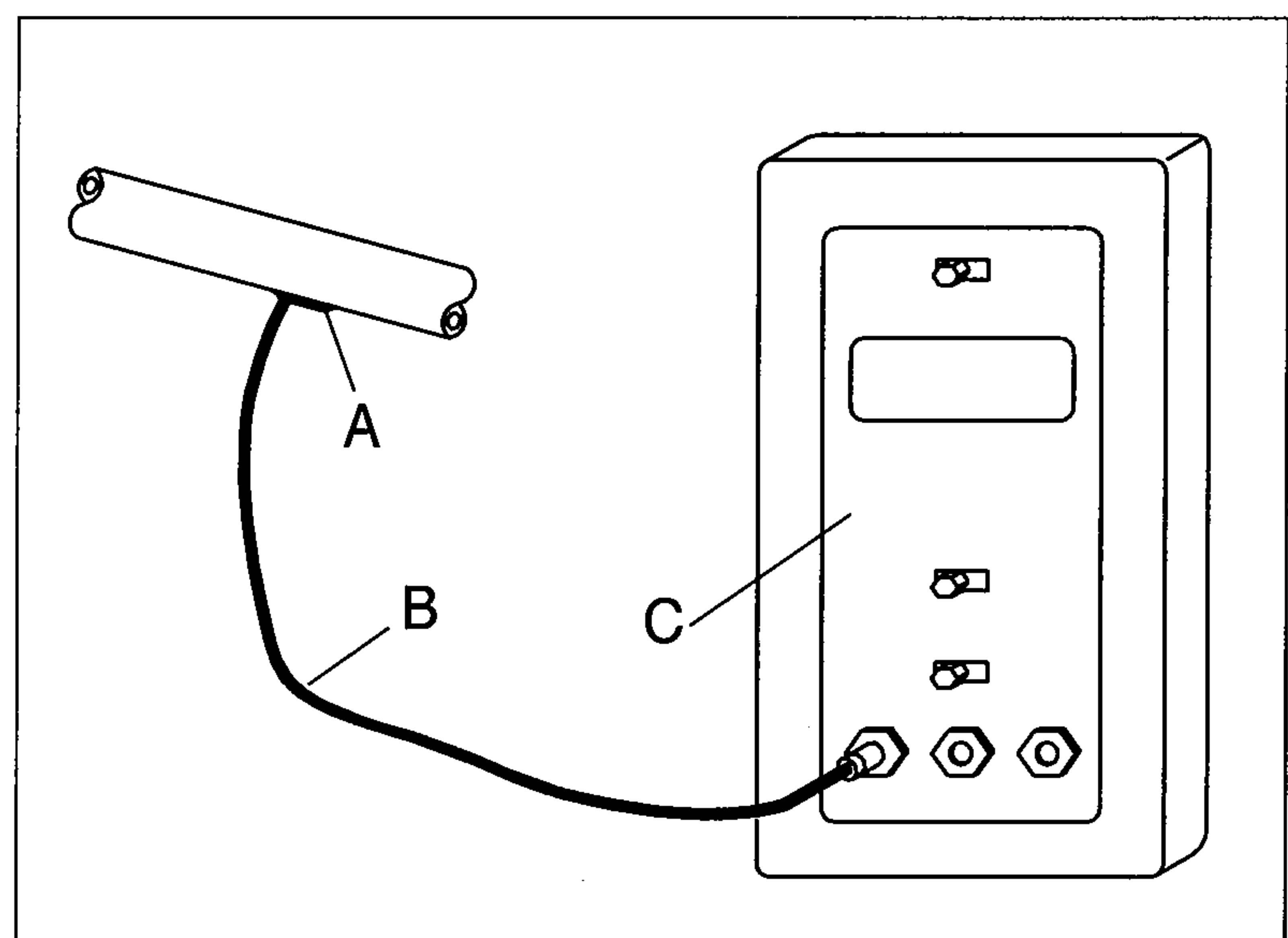

3) DISPLAY MONITOR TACHOMETER

The display monitor tachometer is accurate enough for test work.

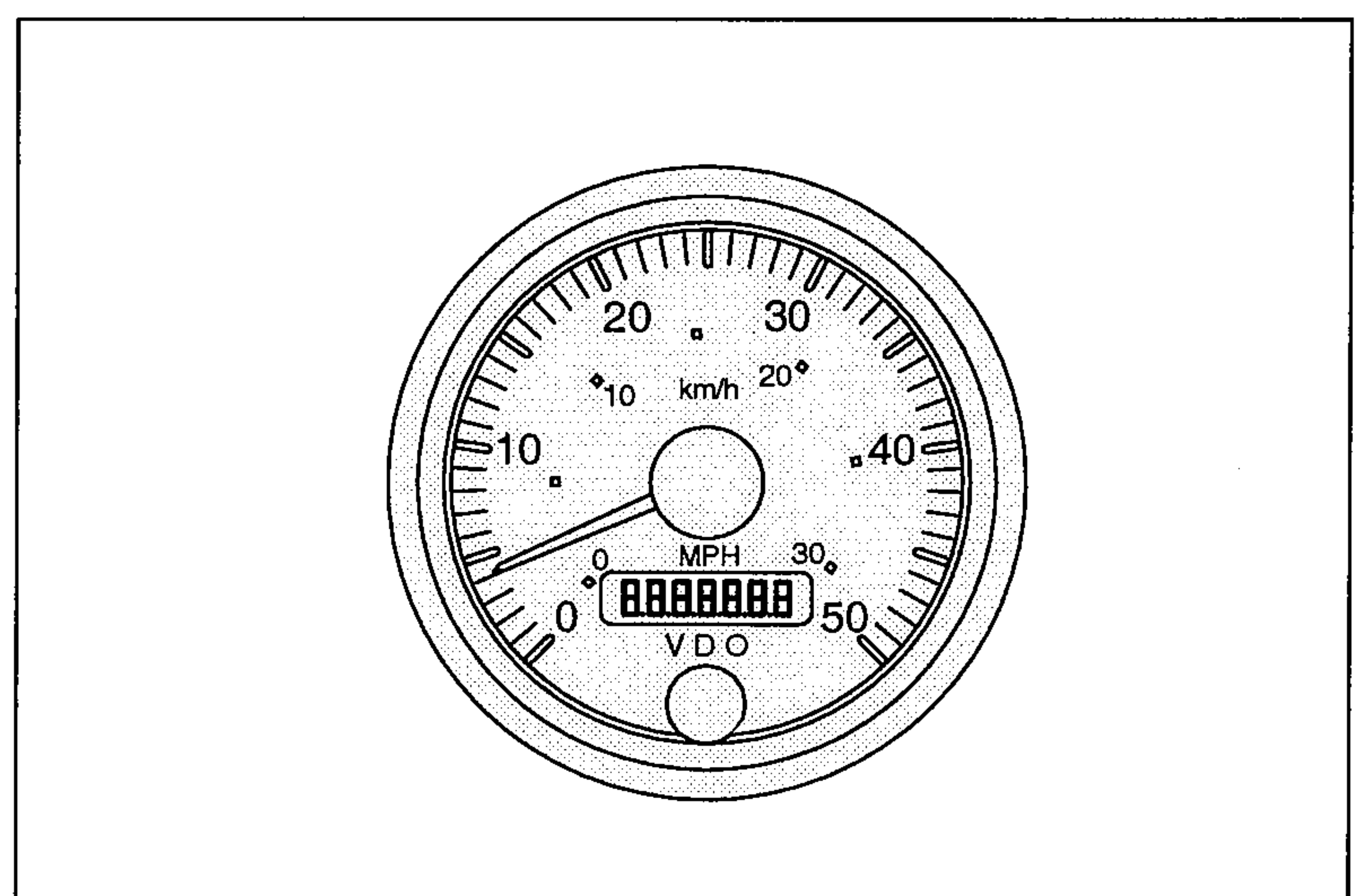

3. STEERING SYSTEM RESTRICTION TEST

- **SPECIFICATION**

Oil temperature $65 \pm 6^{\circ}\text{C}$ ($150 \pm 10^{\circ}\text{F}$)

Engine speed High idle

Maximum pressure 2.1MPa(21bar,300psi)
at steering unit

Loader control valve 2MPa(20bar, 285psi)

- **GAUGE AND TOOL**

Gauge 0~7MPa(0~70bar, 0~1000psi) 2EA

This test will check for restrictions in the steering system which can cause overheating of hydraulic oil.

- 1) Install temperature reader(See temperature reader installation procedure in this group).
- 2) Heat hydraulic oil to specifications(See hydraulic oil warm up procedure at page 6-50).
- 3) Connect gauge to gauge port for steering system.

▲ Do not operate steering or loader functions or test gauge may be damaged.

- 4) Run engine at specification and read pressure gauges.

If pressure is more than specification at the steering unit, inspect flow amplifier for a priority valve spool. Make sure orifice plugs installed in ends of priority valve spool. Check for plugged orifice in flow amplifier LS port.

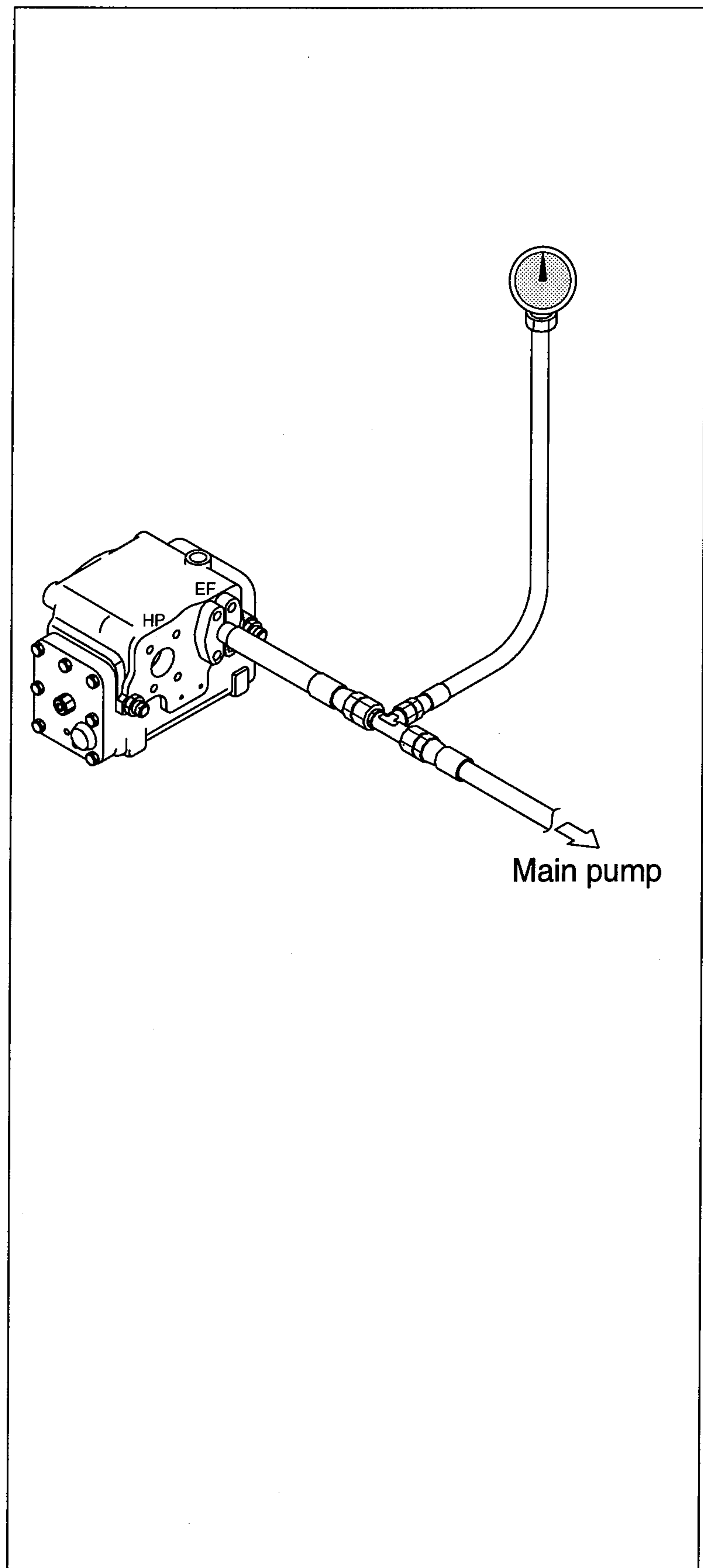

4. STEERING UNIT LEAKAGE TEST

- **SPECIFICATION**

Oil temperature $40 \pm 6^{\circ}\text{C}$ ($100 \pm 10^{\circ}\text{F}$)
Engine speed High idle
Maximum leakage 7.5 l / min (2 gpm)

- **GAUGE AND TOOL**

Temperature reader
Measuring container (Approx. 20 l)
Stop watch

- 1) Install frame locking bar to prevent machine from turning.
- 2) Install temperature reader (See temperature reader installation procedure in this group).
- 3) Heat hydraulic oil to specifications (See hydraulic oil warm up procedure at page 6-50).
- 4) Disconnect return hose from fitting. Install cap fitting.
- 5) Run engine at specifications. Rotate steering wheel against locking bar using approximately $1.2 \text{ kgf} \cdot \text{m}$ of force. Measure oil flow from return hose for 1 minute.
- 6) Leakage is greater than specifications, repair or replace steering unit.

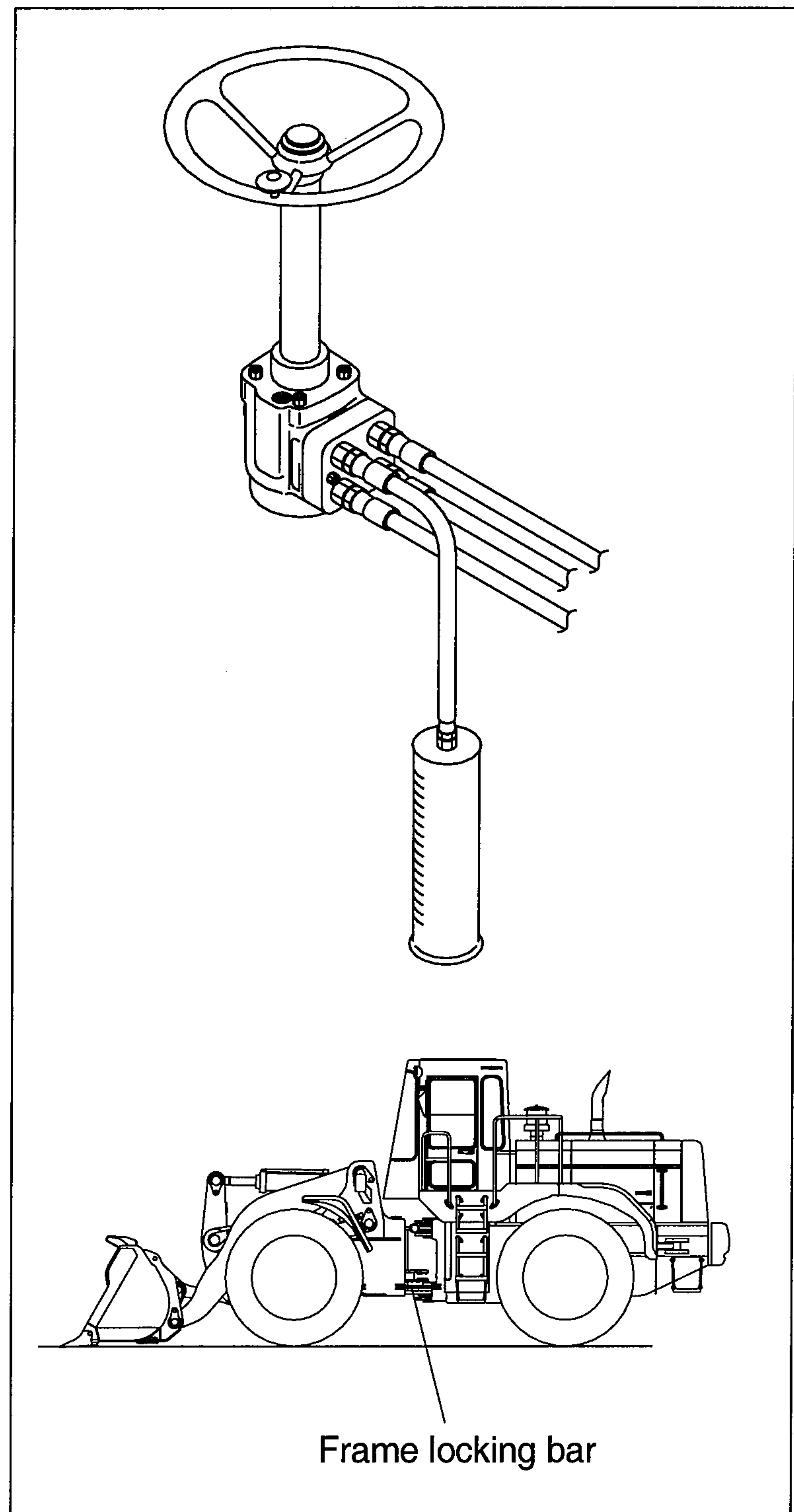

5. FLOW AMPLIFIER PRESSURE TEST

• SPECIFICATION

Oil temperature	$65 \pm 6^{\circ}\text{C}$ ($150 \pm 10^{\circ}\text{F}$)
Engine speed	High idle
Oil pressure	20.1~21.1MPa (205~215bar, 2900~3100psi)

• GAUGE AND TOOL

Gauge 0~35MPa(0~350bar, 0~5000psi)
Temperature reader

- 1) Connect gauge to test port.
- 2) Install temperature reader(See installation procedure in this group).
- 3) Install frame locking bar.
- 4) Heat hydraulic oil to specifications(See hydraulic oil warm up procedure at page 6-50).

- 5) Run engine at specifications and turn steering wheel rapidly hold approximately 22N(5lb force) pressure on wheel with frames locked.

※ **If steering wheel is turned slowly, it will continue to with the frames locked.**

This will give an incorrect pressure reading.

If steering wheel continues to turn rapidly with the frames locked, steering system leakage is indicated.

- 6) Read pressure gauge. This is the flow amplifier relief pressure.

- 7) If pressure is not to specification, turn adjusting screw in relief cartridge using a hex head wrench to adjust pressure.

If pressure cannot be adjusted to specification, disassemble and inspect flow amplifier.

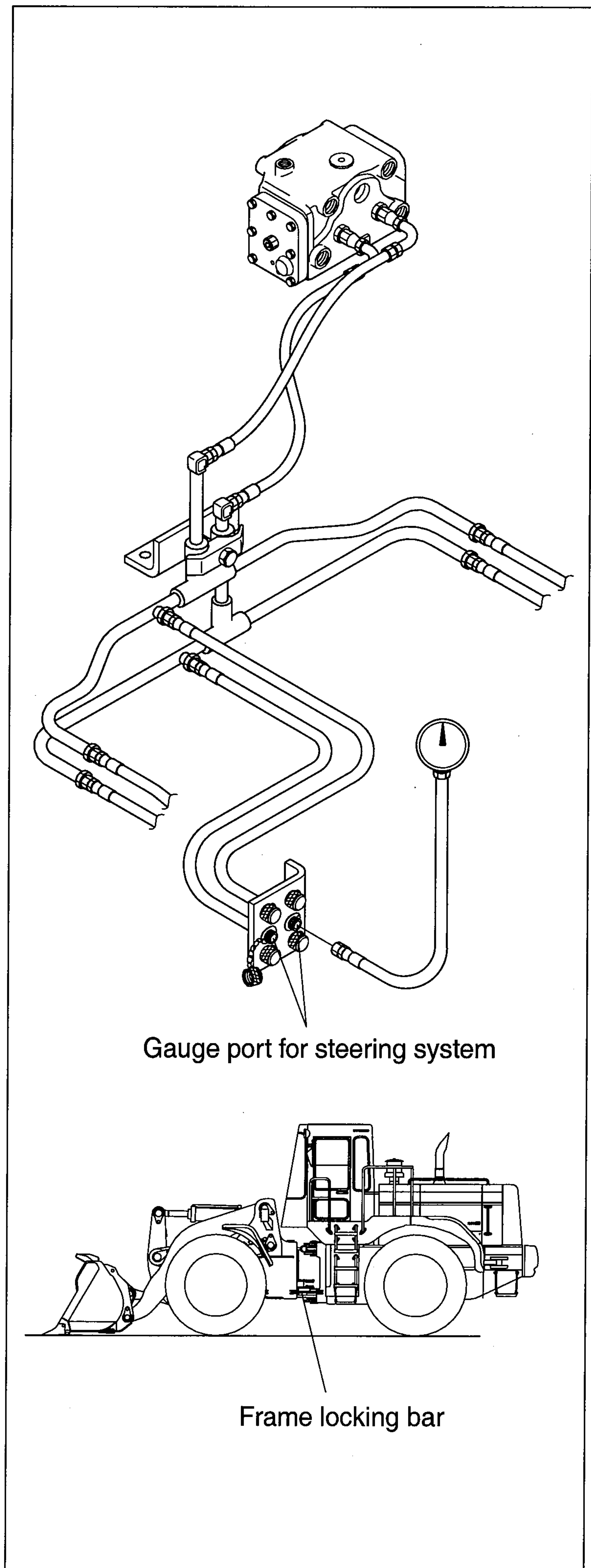

6. FLOW AMPLIFIER LS PORT FLOW TEST

• SPECIFICATION

Oil temperature	$40 \pm 6^{\circ}\text{C}$ ($100 \pm 10^{\circ}\text{F}$)
Engine speed	Low idle
LS port flow (approx.)	1 l /min (0.3 gpm)

• GAUGE AND TOOL

Temperature reader
Measuring container
Stop watch

Flow amplifier LS port flow test will check for a plugged or missing orifice in the bottom of the priority valve spool. A plugged orifice will block warm up flow to the steering unit which can cause thermal shock (See for an explanation of thermal shock).

A missing orifice can cause the pump to be loaded to high pressure at all times causing overheating.

- 1) Install temperature reader (See temperature reader installation procedure in this group.)
- 2) Heat hydraulic oil to specifications (See hydraulic oil warm up procedure at page 6-50).
- 3) Disconnect line from LS port and install plug (A).
- 4) Connect line (B) to flow amplifier.
- 5) Start engine and run at specification.
- 6) Measure flow from LS port for 1 minute.

If flow is low, low steering system neutral pressure or a plugged orifice in bottom priority valve spool is indicated.

If flow is high, remove priority valve spool and inspect for a missing orifice.

Do hydraulic system restriction test in this group.

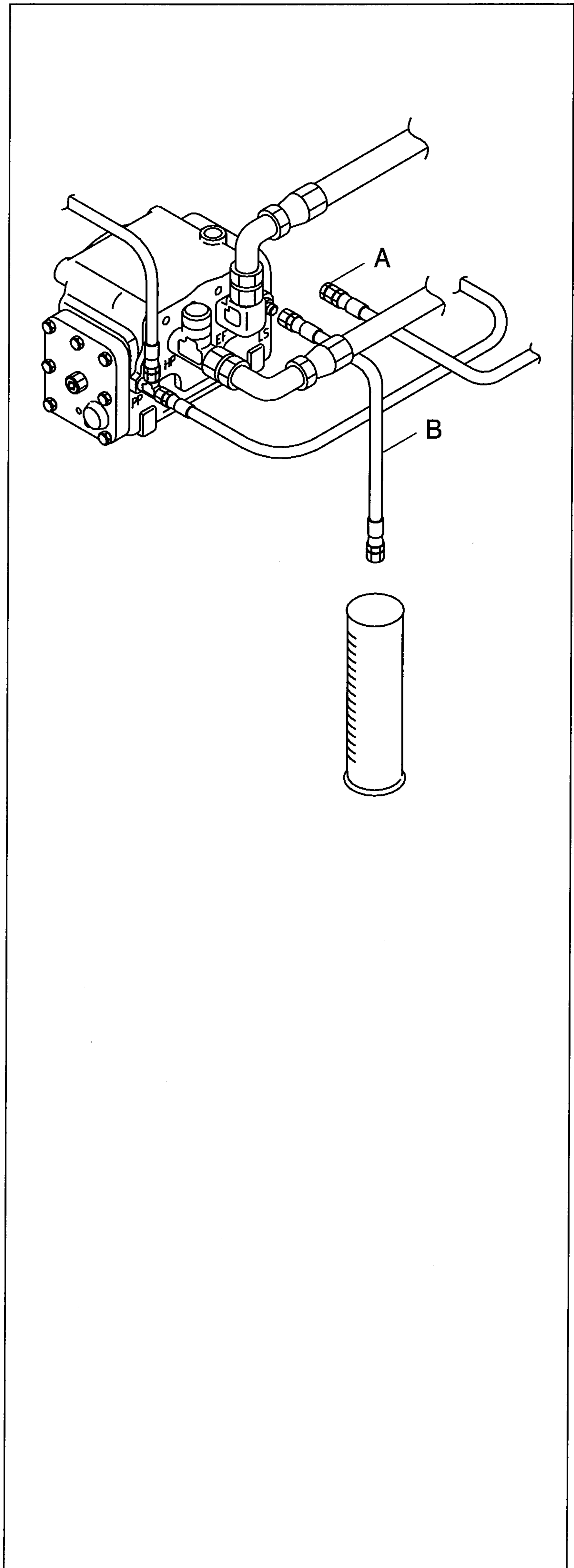

7. FLOW AMPLIFIER RELIEF CARTRIDGE LEAKAGE TEST

• SPECIFICATION

Oil temperature $40 \pm 6^{\circ}\text{C}$ ($100 \pm 10^{\circ}\text{F}$)
Engine speed High idle
Maximum leakage 1 m l /min (1.6 drops per min)

• GAUGE AND TOOL

Temperature reader
Measuring container
Stop watch

- 1) Install temperature reader (See temperature reader installation procedure in this group).
- 2) Heat hydraulic oil to specifications (See hydraulic oil warm up procedure at page 6-50).
- 3) Disconnect line from T port on flow amplifier. Install plug (A) in line.
- 4) Connect line (B) to flow amplifier.
- 5) Start engine and run at specification.
- 6) Measure oil leakage from T port.
- 7) If leakage is more than specification, disassemble and inspect cartridge for damage or debris.

