

GROUP 4 DISASSEMBLY AND ASSEMBLY

1. CONTROL VALVE

1) DISASSEMBLY

(1) Illustration on the right shows the complete control unit.

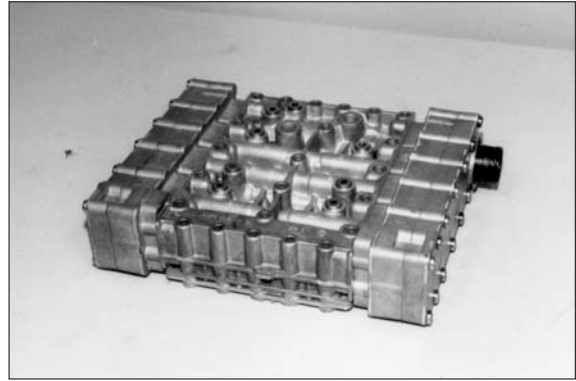

73073CV001

(2) Mark the installation position of the different covers, the housing and cable harness with the valve housing.

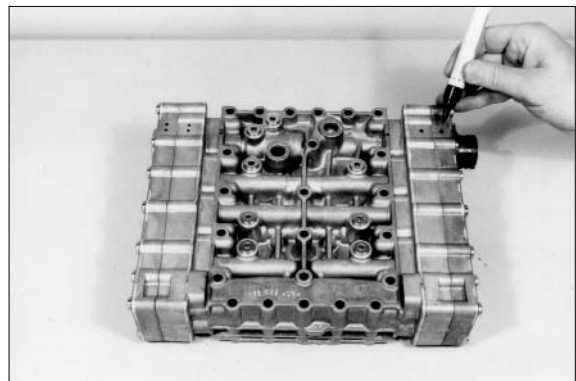

73073CV002

(3) Loosen socket head screws.
Separate duct plate, 1st gasket, intermediate plate and 2nd gasket from the valve housing.

※ Special tool

Box spanner

5873 042 002

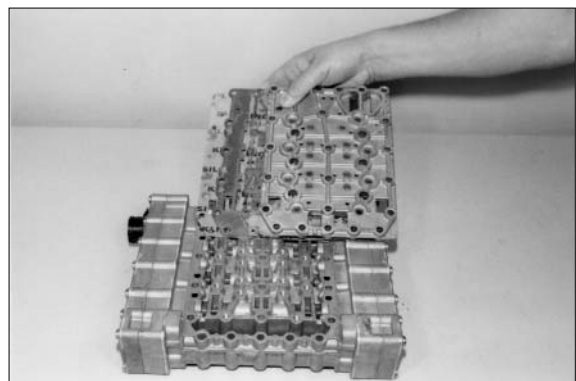

73073CV003

(4) Remove retaining clip.

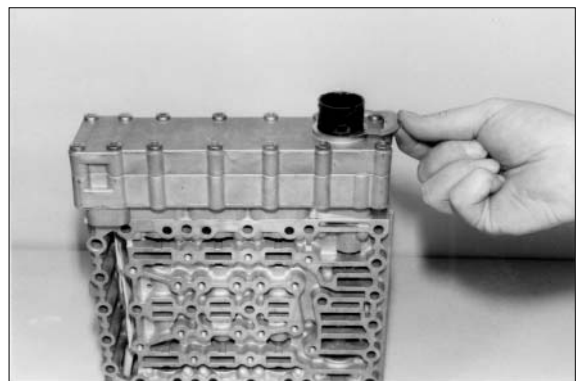

73073CV004

- (5) Loosen socket head screws.
Separate cover from housing and cable harness.

※ Special tool
Box spanner

5873 042 002

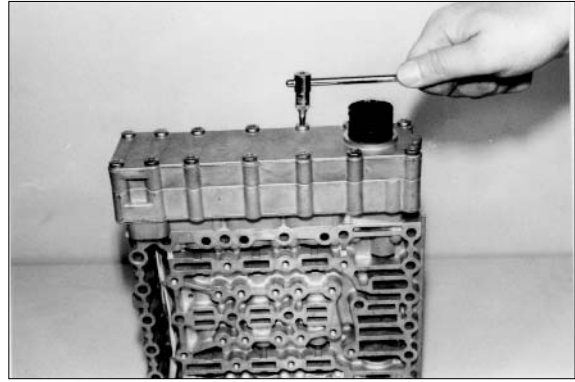

73073CV005

- (6) Disassemble opposite cover.
Disconnect pressure regulator and remove cable harness.

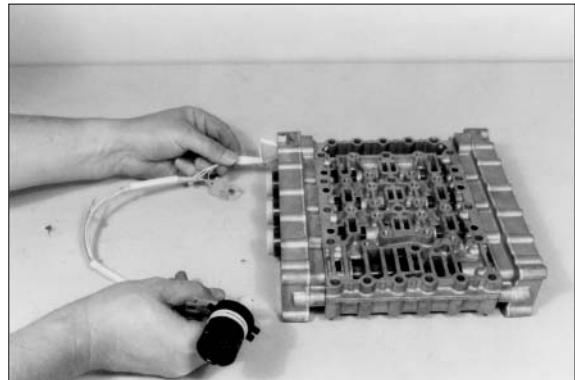

73073CV006

- (7) Loosen socket head screws, remove fixing plate and pressure regulators(3EA).

※ Special tool
Box spanner

5873 042 002



73073CV007

- (8) Loosen two socket head screws and locate housing provisionally, using adjusting screws(Housing is under spring preload).
Now, loosen remaining socket head screws.

※ Special tool
Box spanner
Adjusting screws

5873 042 002

5870 204 036

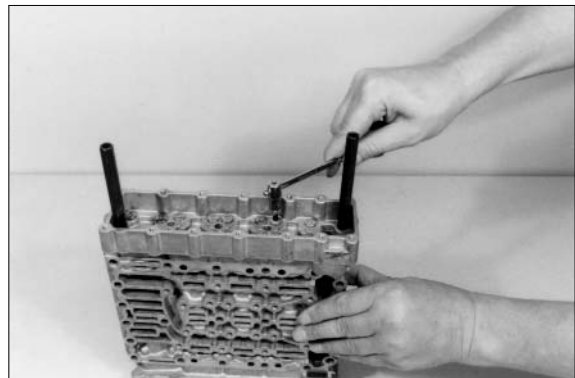

73073CV008

(9) Separate housing from valve housing by loosening the adjusting screws uniformly.

※ Special tool

Adjusting screws 5870 204 036

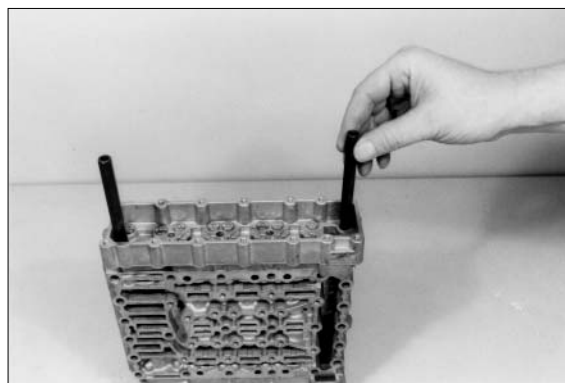

73073CV009

(10) Remove components.

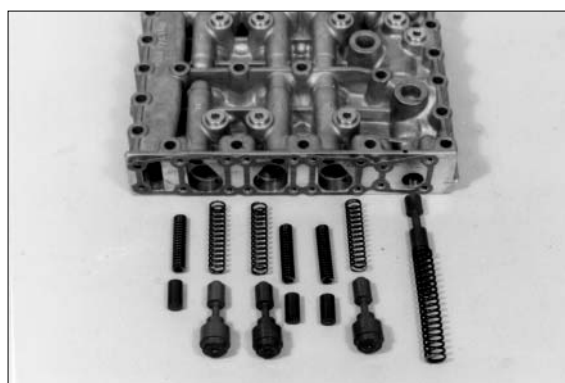

73073CV010

(11) Remove opposite pressure regulators, housing as well as components accordingly.



73073CV011

2) ASSEMBLY

※ Check all components for damage and renew if necessary.

Prior to the installation, check free travel of all moving parts in the housing.

Spools can be exchanged individually.

Oil the components prior to the assembly.

Insert diaphragms with the concave side showing upward until contact is obtained.

※ Installation position, see arrows.

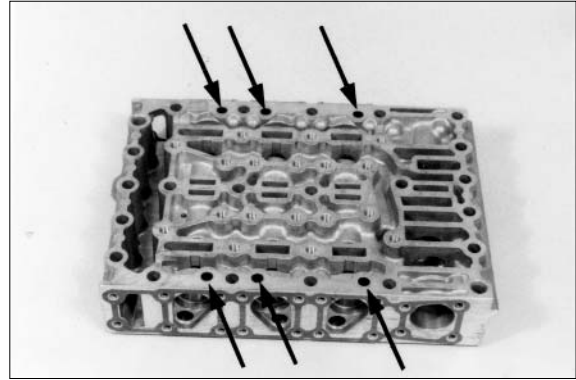

73073CV015

(1) Illustration on the right shows the following components.

- 1 Vibration damper
- 2 Follow-on slide
- 3 Pressure reducing valve

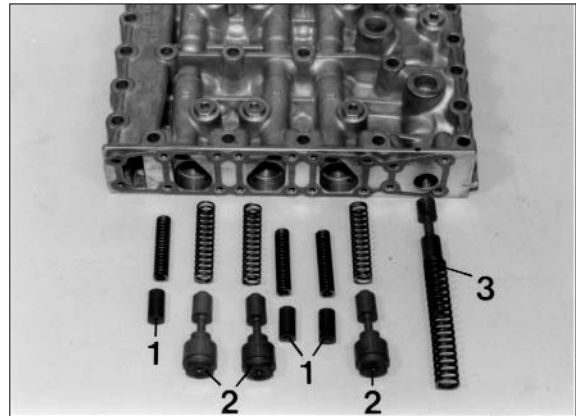

73073CV016

(2) Install components according to figure (1).

※ Preload compression spring of the follow-on slides and locate spool provisionally by means of cylindrical pins $\varnothing 5.0\text{mm}$ (Assembly aid), see arrows.

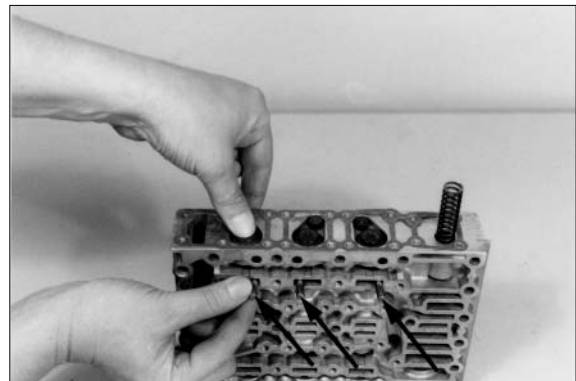

73073CV017

(3) Install two adjusting screws.

Assemble gasket (Arrow 1) and housing cover. Now, position the housing cover uniformly, using adjusting screws, until contact is obtained and remove cylindrical pins (Assembly aid) again (See the next figure).

※ Pay attention to the different housing covers. Install recess $\varnothing 15\text{mm}$ (Arrow 2), facing the spring of the pressure reducing valve.

Adjusting screws 5870 204 036

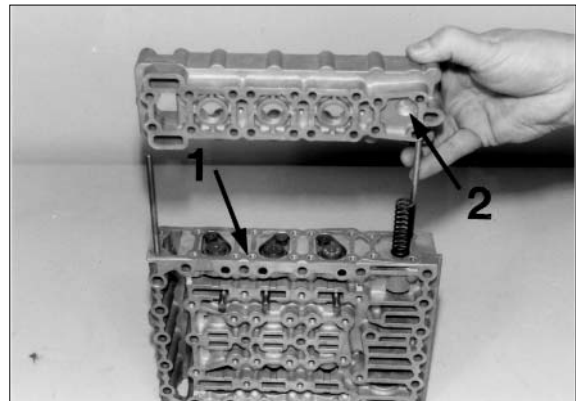

73073CV018

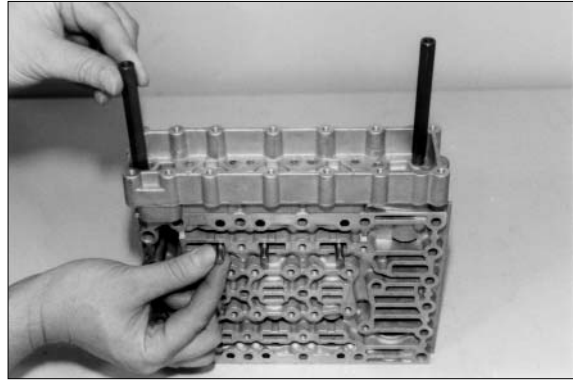

73073CV019

(4) Fasten housing cover by means of socket head screws.

· Torque limit : 0.56kgf · m(4.06lbf · ft)

※ Special tool

Box spanner 5873 042 002

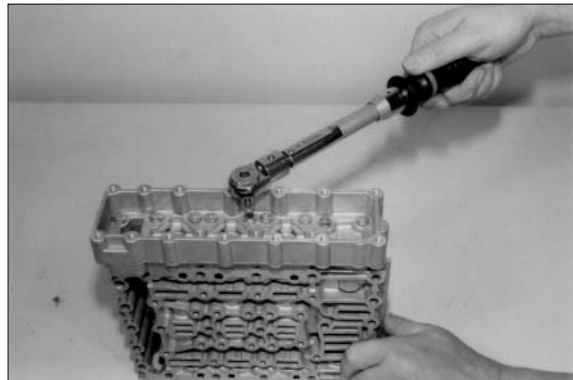

73073CV020

(5) Introduce pressure regulators and fix by means of fixing plates and socket head screws.

※ Install fixing plate, with the claw showing downward.

Pay attention to the radial installation position of the pressure regulators, see figure.

· Torque limit : 0.56kgf · m(4.06lbf · ft)

※ Special tool

Box spanner 5873 042 002

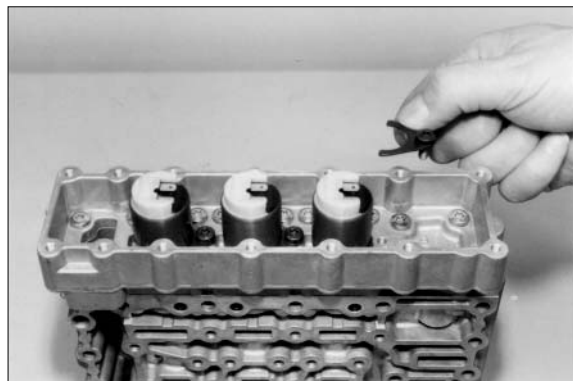

73073CV021

Pre assemble opposite side

(6) Illustration on the right shows the following components.

- 1 Main pressure valve
- 2 Follow on slide
- 3 Vibration damper

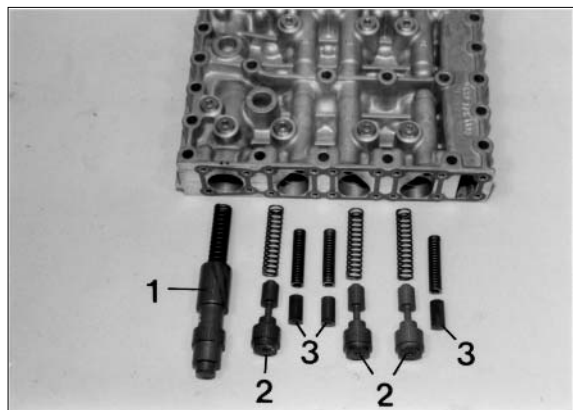

73073CV022

- (7) Install components according to figure (6).
 Preload compression springs of the follow-on slides and locate spool provisionally by means of cylindrical pins \varnothing 5.0mm (Assembly aid), see arrows.
 Install two adjusting screws.

Assemble gasket(Arrow 1) and housing cover, and position them uniformly against shoulder, using adjusting screws.

- ※ Pay attention to the different housing covers-install the recess \varnothing 19mm(Arrow 2), facing the main pressure valve.

Now, fasten housing cover by means of socket head screws.

- Torque limit : 0.56kgf · m(4.06lbf · ft)

Remove cylindrical pins(Assembly aid) again.

- ※ Special tool

Adjusting screws 5870 204 036

Box spanner 5873 042 002

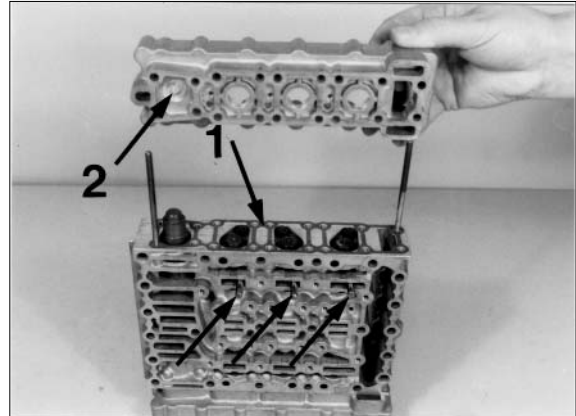

73073CV023

- (8) Introduce pressure regulators and fix by means of fixing plates and socket head screws.

- ※ Install fixing plates, with the claw showing downward.

Pay attention to the radial installation position of the pressure regulators, see figure.

- ※ Special tool

- Torque limit : 0.56kgf · m(4.06lbf · ft)

Box spanner 5873 042 002



73073CV024

- (9) Introduce cable harness and connect pressure regulators(6EA).

- ※ Pay attention to the installation position of the cable harness, see also markings (See figure(2), page 3-78).

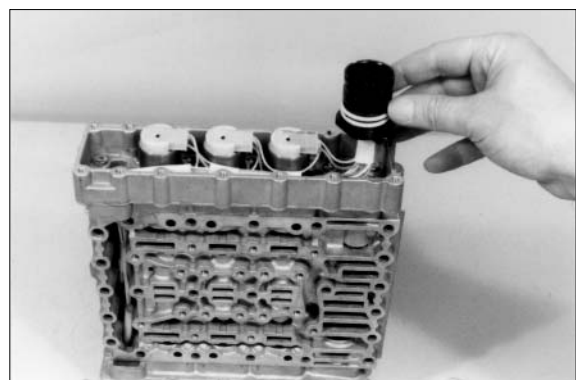

73073CV025

(10) Introduce female connector against shoulder, with the groove facing the guide nose of the cover.

Install gasket (Arrow) and fasten cover by means of socket head screws.

· Torque limit : 0.56kgf · m(4.06lbf · ft)

※ Special tool

Box spanner 5873 042 002

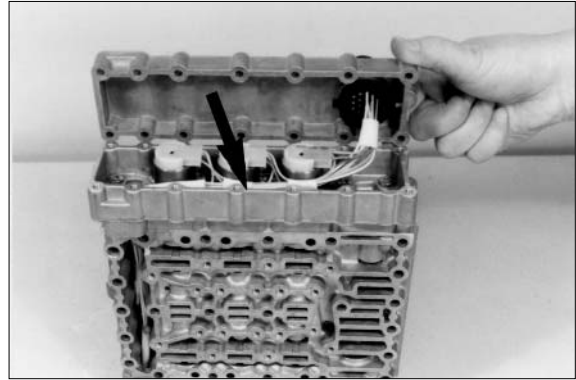

73073CV026

(11) Fix female connector by means of retaining clamp, see figure.

Install opposite cover.

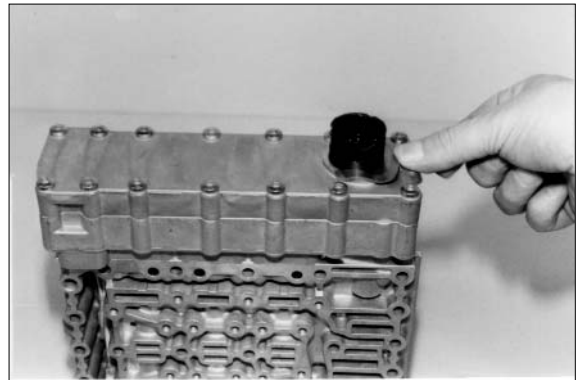

73073CV027

(12) Install two adjusting screws and mount gasket I.

※ Pay attention to the different gaskets, see on the right figure and (15).

※ Special tool

Adjusting screws 5870 204 063

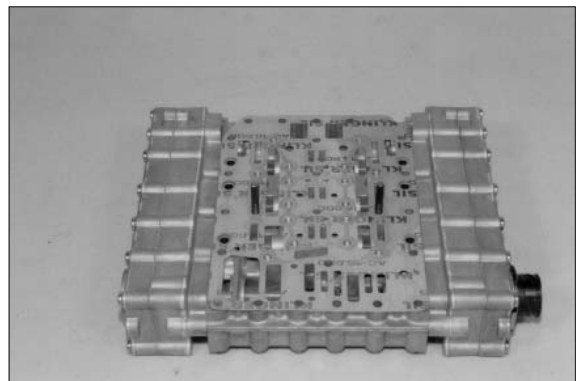

73073CV028

Intermediate plate-Version with screens

(13) Insert screws(6EA) flush mounted into the bore of the intermediate plate, see arrow.

※ Pay attention to the installation position-screws are showing upward(Facing the duct plate).

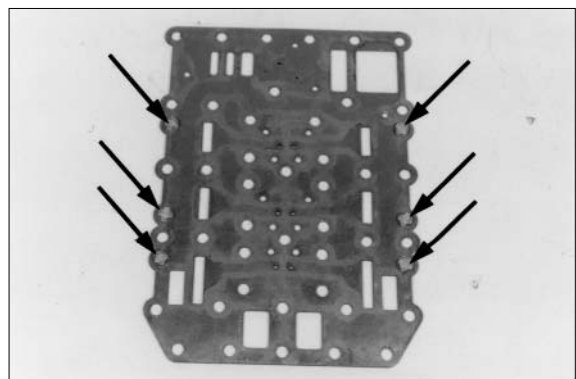

73073CV029

(14) Mount intermediate plate, with the screens showing upward.

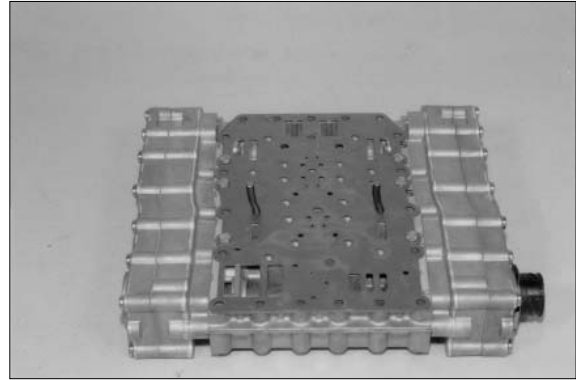

73073CV030

(15) Mount gasket II.

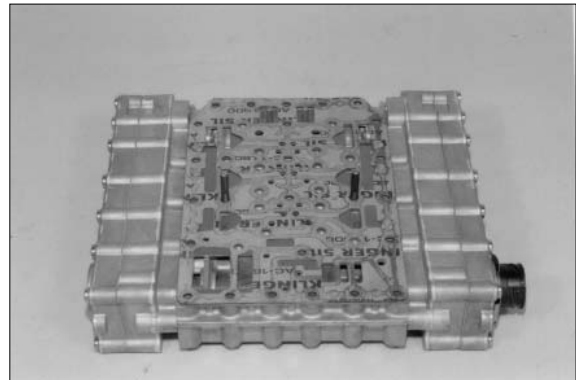

73073CV031

(16) Mount duct plate and fasten it uniformly by means of socket head screws.

· Torque limit : 0.97kgf · m(7.0lbf · ft)

※ Special tool

Box spanner

5873 042 002

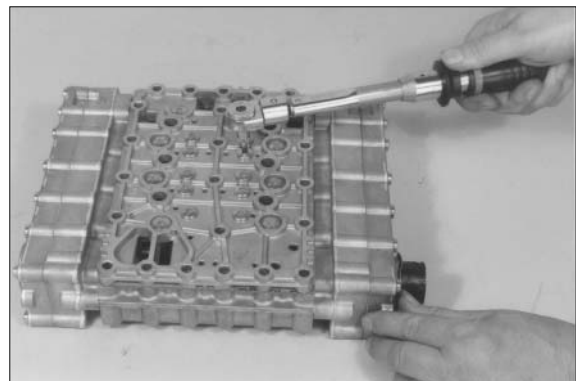

73073CV032

(17) Equip screw plug(8EA) with new O-rings and install them.

· Torque limit : 0.61kgf · m(4.43lbf · ft)

※ The installation of the hydraulic control unit is described, starting from page 3-139.

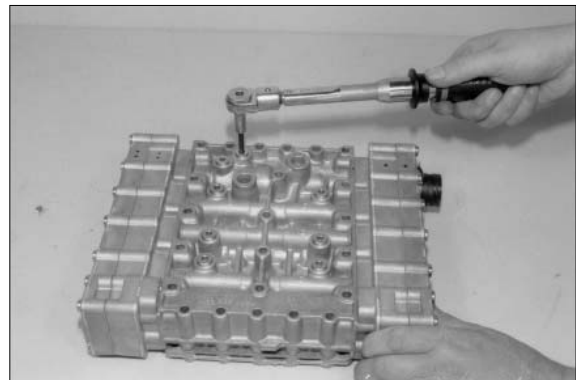

73073CV033

2. TRANSMISSION

1) DISASSEMBLY

(1) Remove filter unit

- ① Demount warning switch(Arrow) from filter head.

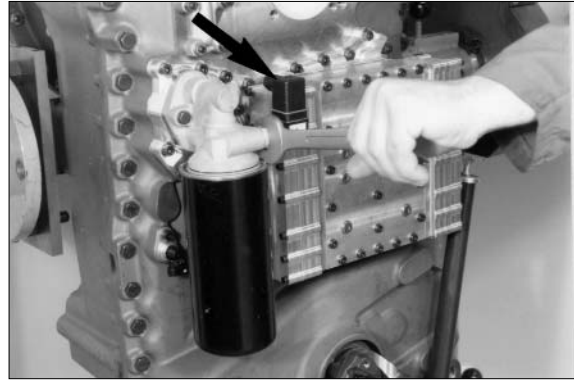

73073TM002

- ② Separate oil filter from filter head.

※ Special tool

Belt spanner

5870 105

005

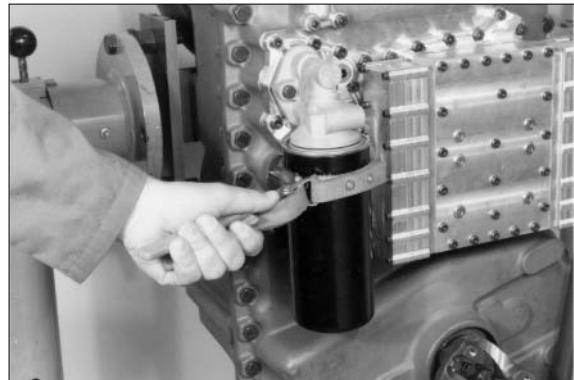

73073TM003

- ③ Loosen hexagon head screws and separate filter head from duct plate.

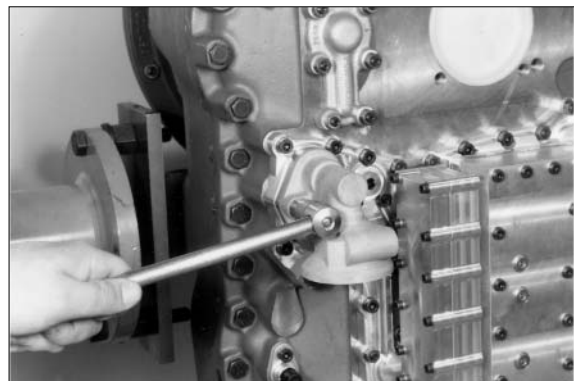

73073TM004

(2) Separate hydraulic control unit and duct plate from gearbox housing

- ① Loosen socket head screws, install two adjusting screws and separate control unit from duct plate.

※ Special tool

Adjusting screw

5870 204

031

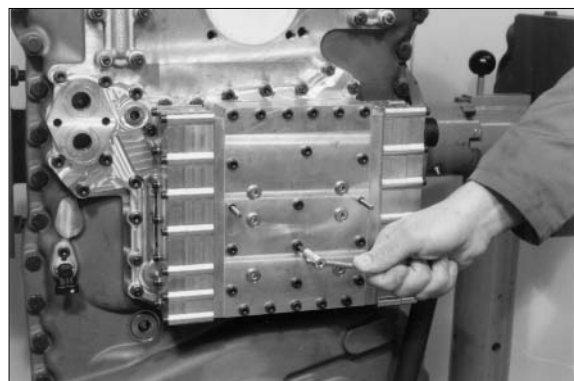

73073TM004

② Remove both gaskets as well as intermediate plate.

※ Special tool
Adjusting screws 5870 204 031

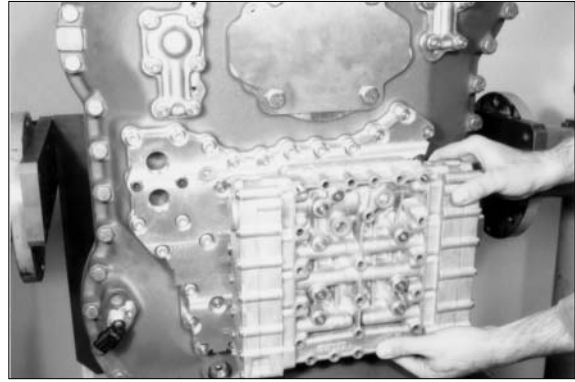

75773TM051

③ Loosen socket head screws and hexagon nuts and separate duct plate from gearbox housing.
Now, remove flat gasket.

※ Special tool
Adjusting screws 5870 204 031

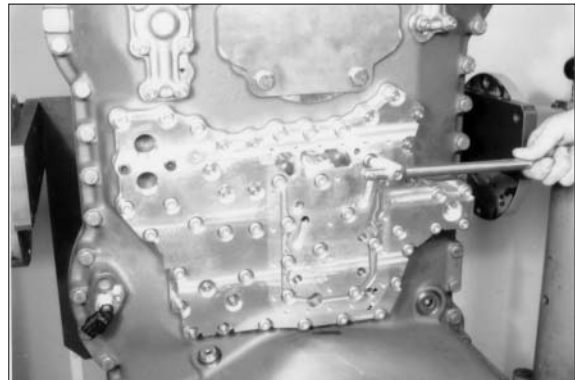

75773TM052

③ Remove and disassemble converter safety valve

① Pull converter safety valve out of the housing bore.

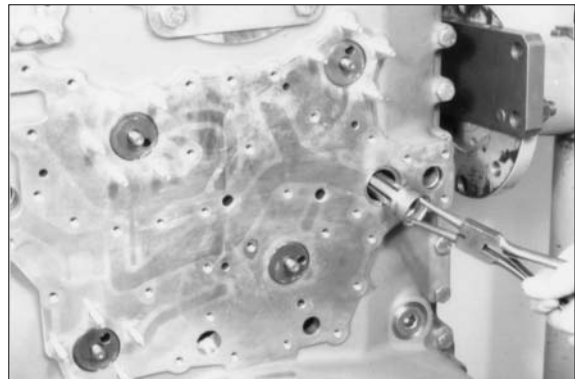

75773TM053

② Illustration on the right shows the required special tool for the disassembling of the converter safety valve.

1 Converter safety valve

※ Special tool
Assembly aid 5870 345 084

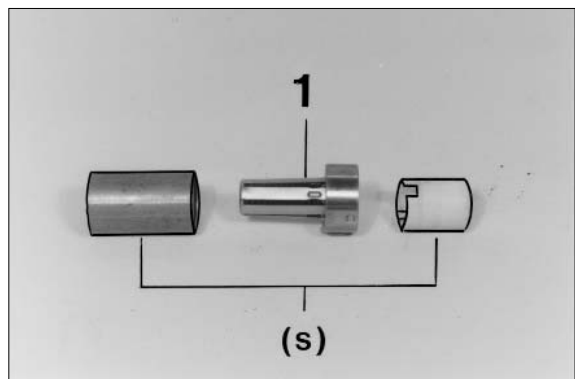

73073TM009

- ③ Preload compression spring carefully, remove cylindrical pin(See on the right figure) and demount components(See on the below figure).

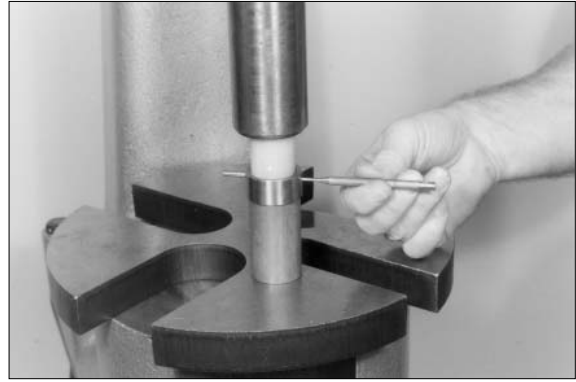

73073TM010



73073TM011

(4) Engine connection-Converter

- ① Remove lock plate and loosen hexagon head screws.
Remove disk and pry input flange from the shaft.



73073TM015

- ② Loosen screw connection.
※ Mark radial installation position of the housing cover.



73073TM016

③ Separate cover along with converter from the transmission, using lifting device.

※ Special tool

Set of eye bolts 5870 204 002

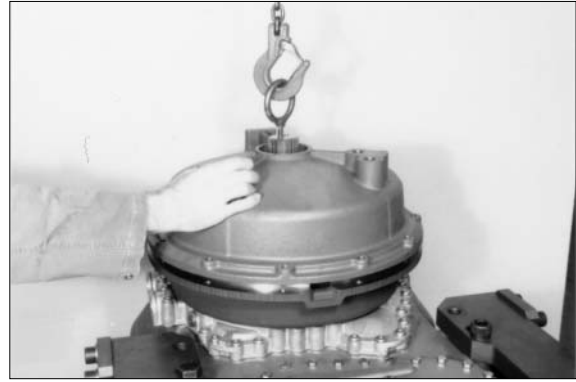

75773TM057

④ Press input shaft, respectively converter out of the cover(Ball bearing).

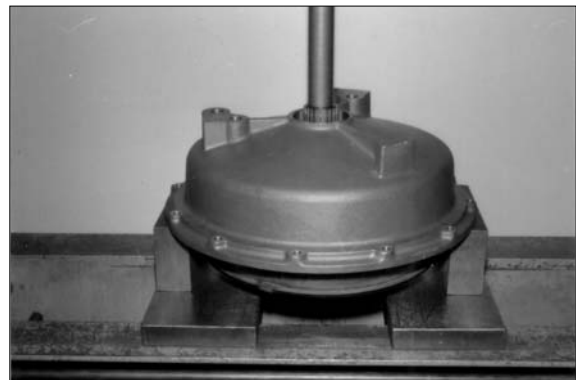

75773TM058

⑤ Squeeze circlip out and remove ball bearing.

※ Special tool

Set of internal pliers 5870 900 013



75773TM059

⑥ Loosen hexagon head screws and separate membrane from converter.

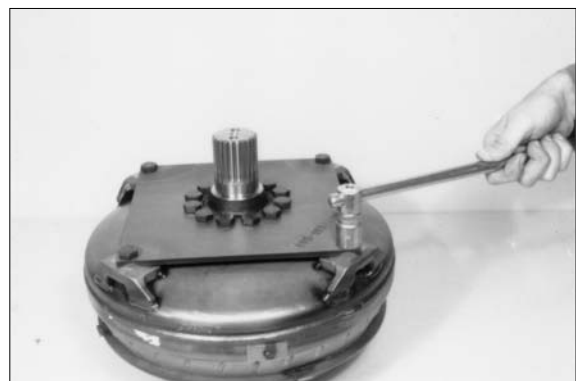

75773TM060

- ⑦ Loosen hexagon head screws and separate input shaft from the membrane.

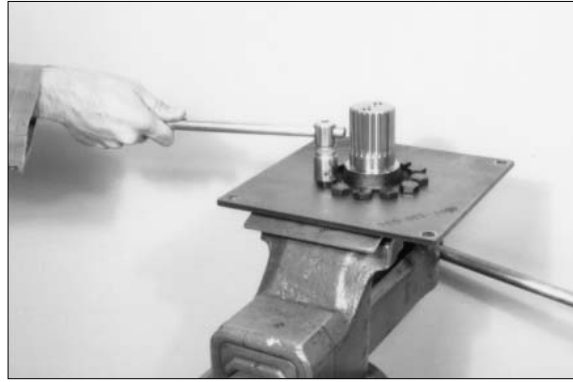

75773TM061

- ⑧ Remove inductive transmitter(n Enging).

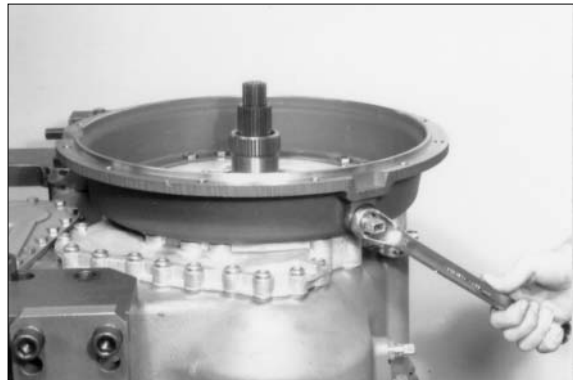

75773TM062

- ⑨ Loosen hexagon head screws and remove converter housing.



75773TM063

(5) Remove transmission pump

- ① Loosen socket head screws.

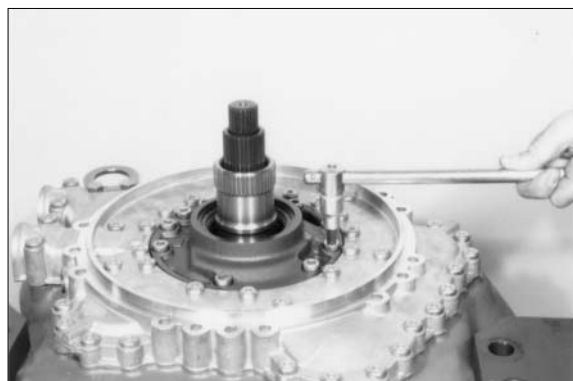

75773TM064

- ② Apply separating device on the splines runout of the stator shaft and pull pump out of the housing bores, using two-leg puller.

※ Special tool

Separating device 5870 300 024

Two-leg puller 5870 970 004



75773TM065

- ③ Separate transmission pump from stator.
Separate cam plate from pump.

※ If traces of wear should be encountered in the pump housing or the cam disk, the complete pump has to be renewed.

Now, fit cam disk again and fix it by means of grooved pins(2EA).



75773TM066

- ④ Loosen hexagon head screws and remove oil feed housing.
Now, remove flat gasket.

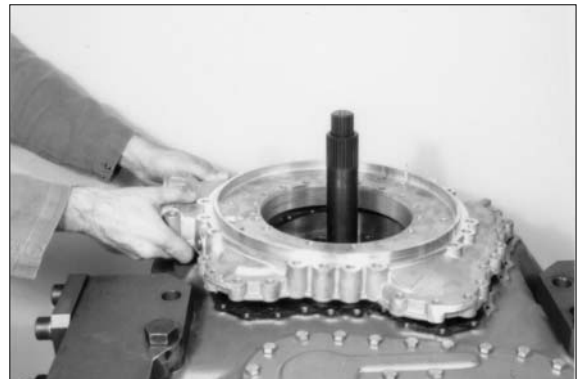

75773TM067

(6) Converter pressure valve

- ① Pull converter pressure valve out of the housing bore.



73073TM028

- ② Illustration on the right shows the special tool required for the disassembling of the converter pressure valve.

1 Converter pressure valve

※ Special tool

Assembly aid 5870 345 084

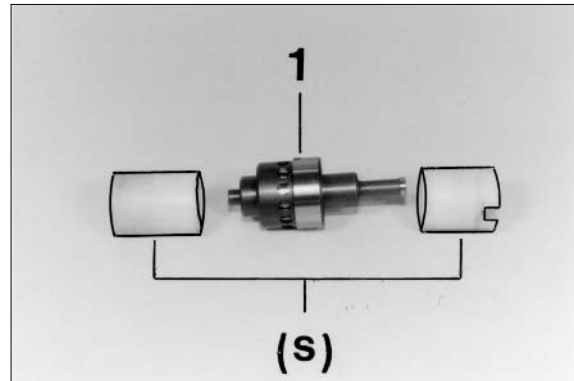

73073TM029

- ③ Preload compression spring carefully, drive roll pin out and remove components.

※ Special tool

Assembly aid 5870 345 084



73073TM030

- ④ Loosen hexagon head screws, demount cover and remove flat gasket.

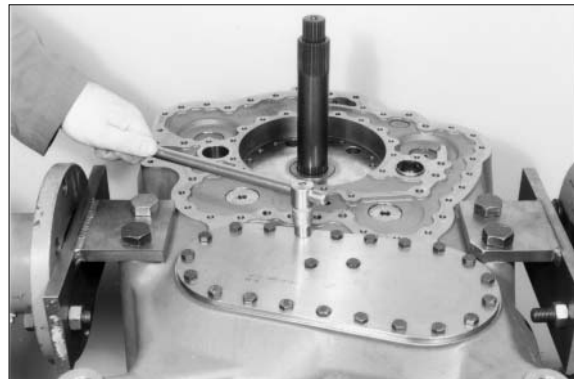

73073TM031

(7) Demount output, input and clutches

- ① Remove lock plate, loosen hexagon head screws, and pry the converter-side output flange from the shaft.

Now, pry shaft seal out of the housing bore.

Tilt gearbox 180° and remove rear output flange accordingly.

※ Special tool

Pry bar 5870 345 065



73073TM035

- ② Demount speed sensor as well as both inductive transmitters(Arrows).

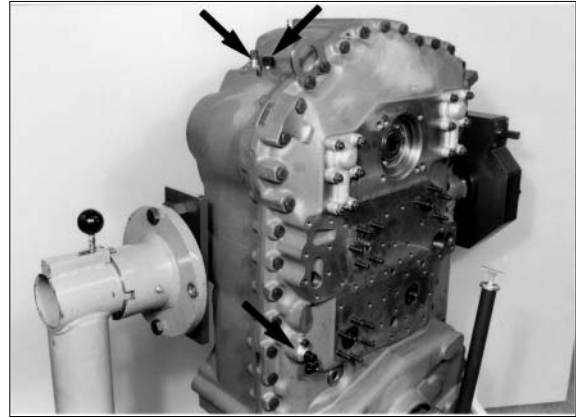

73073TM036

- ③ Loosen hexagon nuts and remove the two covers(Arrows).
Loosen screw connection.

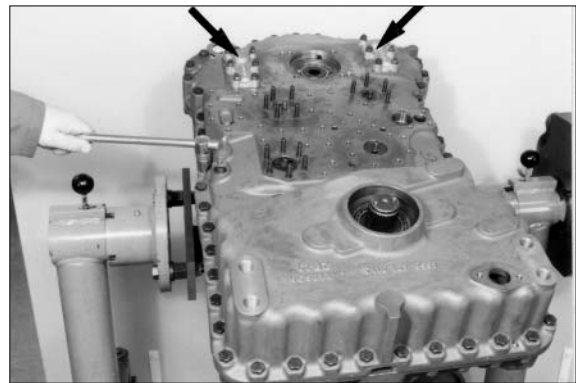

73073TM037

- ④ Drive both cylindrical pins(Arrows) out.



73073TM038

- ⑤ Separate housing cover carefully from gearbox housing, using lifting device.

※ Special tool

Lifting chain

5870 281 047

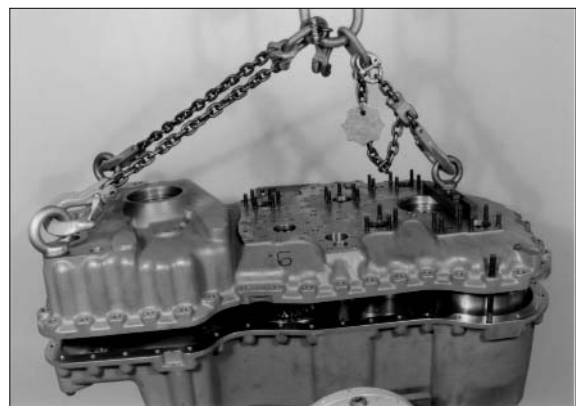

73073TM039

- ⑥ On the right figure shows the installation position of the single clutches as well as of the input and output.

KV Forward clutch
KR Reverse clutch
K1 1st speed clutch
K2 2nd speed clutch
K3 3rd speed clutch
K4 4th speed clutch
AN Input
AB Output

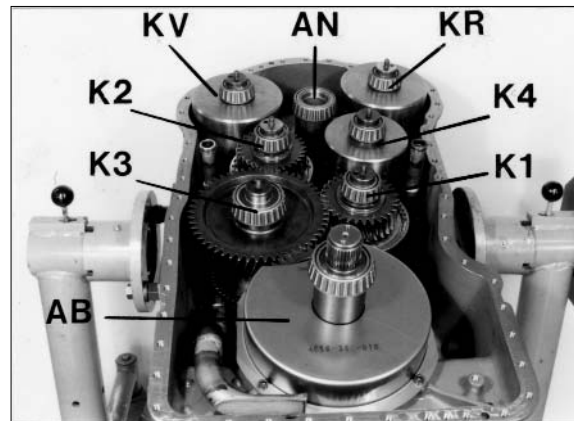

73073TM040

- ※ The following figures describe the common removal of all clutches.

For this purpose, the housing cover, combined with special tool is necessary.

The removal of single clutches without help of the housing cover and the handles is extremely difficult because of the installation condition.

Besides, there is the danger of injuries.

- ※ Prior to the common removal of the clutches, the output shaft must be removed, see the below figure.

- ⑦ Loosen socket head screws and remove output shaft as well as both oil baffle plates.



73073TM042

- ⑧ Assemble housing cover carefully until contact is obtained.
Fix all clutches in the housing cover, using handles.

※ Special tool
Handle(6EA needed) 5870 260 010



73073TM201

- ⑨ Separate housing cover along with clutches from gearbox housing, using lifting device.

※ Special tool
Handle(6EA needed) 5870 260 010



73073TM200

- ⑩ Fasten housing cover on assembly car.

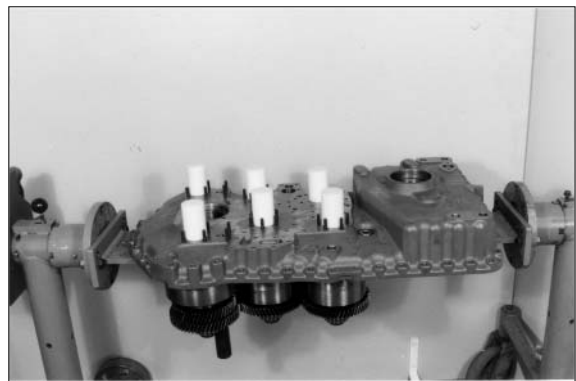

73073TM045

- ⑪ Tilt housing cover 180° .
Remove handles.

※ Special tool
Handle(6EA needed) 5870 260 010

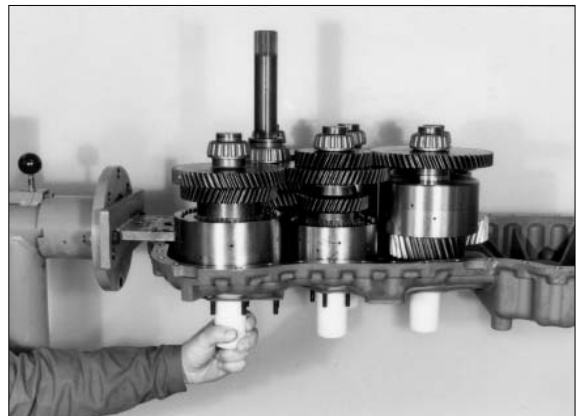

73073TM046

⑫ Remove K2 clutch.



73073TM047

⑬ Remove K1 clutch, at the same time, lift K4 clutch.



73073TM048

⑭ Lift K3 clutch out of the housing cover.



73073TM049

⑮ Remove K4 clutch, at the same time lift input slightly.



73073TM050

- ⑩ Separate KV and KR clutches together with input from the housing cover.



- ⑪ Remove bearing outer race and pull output shaft(Power take-off) out of the housing bore.



- ⑫ Squeeze rectangular ring(Arrow) out and separate ball bearing from shaft.



- ※ If contrary to the recommendation, the tapered roller bearings of the clutches as well as of the input and output would not be renewed, the allocation of the inner and outer races to the single assemblies must at least be maintained.
- ※ Mark bearing inner and outer races accordingly.

(8) Disassemble KV and KR clutch

※ The following figures show the disassembly of the KV clutch.

The disassembly of the KR clutch is analogous.

① Squeeze rectangular ring(Arrow) out.



73073TM54

② Pull tapered roller bearing from the shaft.
Demount opposite tapered roller bearing accordingly.

※ Special tool

Grab sleeve 5873 001 057

Basic set 5873 001 000



73073TM55

③ Separate plate carrier from shaft.

※ Special tool

Hammer 5870 280 004



73073TM56

④ Squeeze snap ring out and remove plate pack.



73073TM57

- ⑤ Preload compression spring, squeeze circlip out and remove components.

※ Special tool

Assembly aid 5870 345 086

Set of external pliers 5870 900 015



73073TM58

- ⑥ Lift piston by means of compressed air out of the cylinder bore and remove it.



73073TM59

- ⑦ Remove both O-rings.



73073TM60

- ⑧ Squeeze inner circlip (Shaft) out.

※ Special tool

Set of external pliers 5870 900 015



73073TM61

- ⑨ Locate idler gear by means of separating device(See on the right figure) and press it from the shaft(See on the below figure).
Remove released needle bearing.

※ Special tool

Separating device 5870 300 028

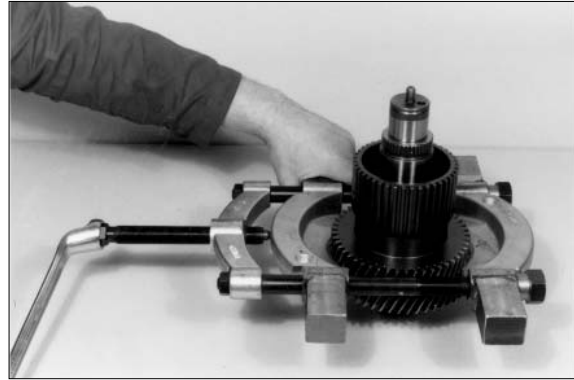

73073TM62

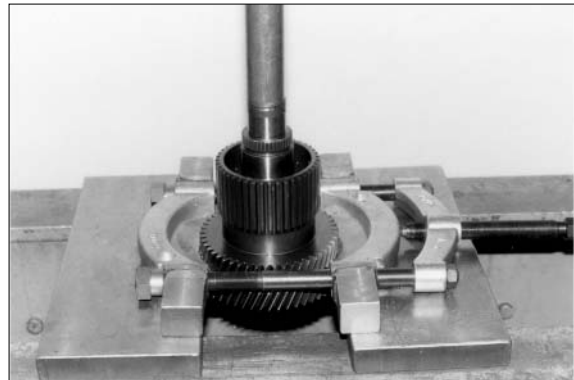

73073TM63

- ⑩ Squeeze circlip out and remove ball bearing.

※ The disassembly of the KR clutch has to be carried out accordingly.

※ Special tool

Set of internal pliers 5870 900 013



73073TM64

(9) Disassemble K1, K2 and K3 clutch

※ The following Figures show the disassembly of the K3 clutch.

The disassembly of the K1 and K2 clutches is analogous.

- ① Squeeze rectangular ring(Arrow) out.



73073TM65

- ② Pull tapered roller bearing from the shaft.
Remove opposite tapered roller bearing accordingly, see Figure ① , ②.

※ Special tool

Grab sleeve 5873 001 057

Grab sleeve 5873 001 058

(K3 on output side)

Basic set 5873 001 000



73073TM66

- ③ Remove running disk, axial needle cage and axial washer.



73073TM67

- ④ Remove idler gear.



73073TM68

- ⑤ Remove both needle bearings as well as axial bearing.



73073TM69

- ⑥ Squeeze snap ring out and remove plate pack.



73073TM70

- ⑦ Preload compression spring, squeeze circlip out and remove components.

※ Special tool

Assembly aid(K2 and K3) 5870 345 085

Assembly aid(K1) 5870 345 086

Set of external pliers 5870 900 015



73073TM71

- ⑧ Press piston out of the plate carrier, using compressed air.

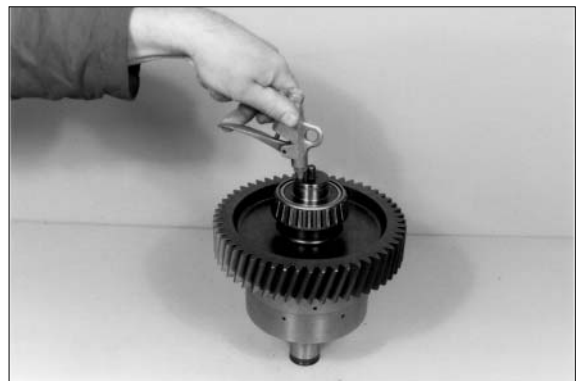

73073TM72

- ⑨ Pry plate carrier from the shaft.

※ Special tool

Pry bar 5870 345 065



73073TM73

(10) Disassemble K4 clutch

- ① Squeeze rectangular ring out and pull tapered roller bearing from the shaft.
Remove opposite tapered roller bearing accordingly.

※ Special tool

Grab sleeve 5873 001 057

Basic set 5873 001 000



73073TM74

- ② Squeeze circlip out and separate plate carrier from the shaft.

※ Special tool

Assembly aid 5870 345 085

Set of external pliers 5870 900 015



73073TM75

- ③ Squeeze snap ring out and demount plate pack.

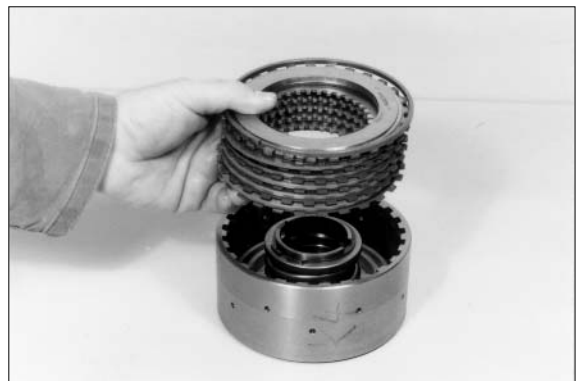

73073TM76

- ④ Preload compression spring, squeeze circlip out and remove components.
Demount piston.

※ The separation of shaft and gear is not possible(Shrink fit).

※ Special tool

Assembly aid 5870 345 085



73073TM77

(11) Disassemble input shaft

- ① If necessary, press turbine shaft out of the input shaft.
- ※ The turbine shaft is axially fixed by means of a snap ring which will be destroyed at the pressing out.

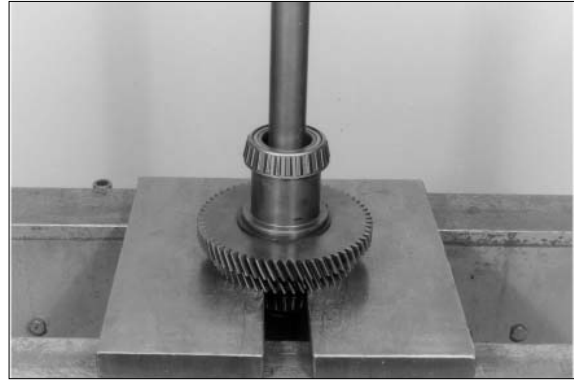

73073TM78

- ② Squeeze rectangular ring out and pull off the tapered roller bearing. Pull off the opposite tapered roller bearing.

- ※ The separation of input shaft 1 and gear 2 is not possible(Shrink fit).
- ※ Special tool
 - Grab sleeve 5873 001 058
 - Basic set 5873 001 000

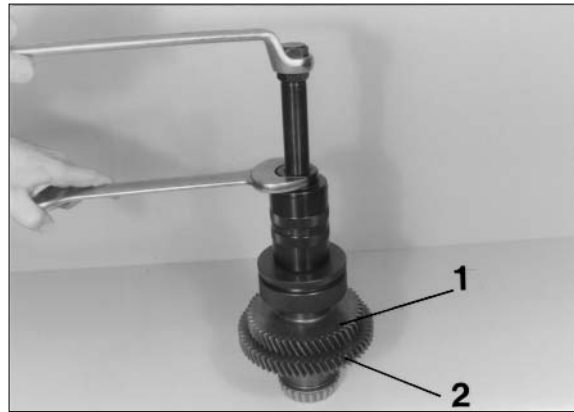

73073TM79

2) ASSEMBLY

- ※ If contrary to the recommendation, the tapered roller bearings of the clutches as well as of the input and output would not be renewed, the allocation of the inner and outer races to the single assemblies must at least be maintained.

(1) Mount oil pipes

- ※ To ensure the correct assembly of the oil pipes, the use of the specified special tool is imperative.

① Install studs(Arrows).

- Torque limit : 0.92kgf · m(6.64lbf · ft)

- ※ Insert studs with Loctite.

② Place distance tubes over the studs.

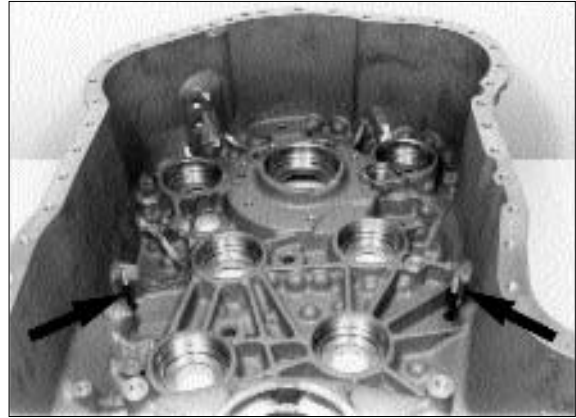

73073TM090



73073TM091

③ Insert suction tube 1, pressure pipe 2 and pressure pipe lubrication 3 into the housing bores.

Fasten suction tube 1 and pressure pipes 2 provisionally by means of socket head screw and hexagon nuts.

- Torque limit : 2.35kgf · m(17.0lbf · ft)

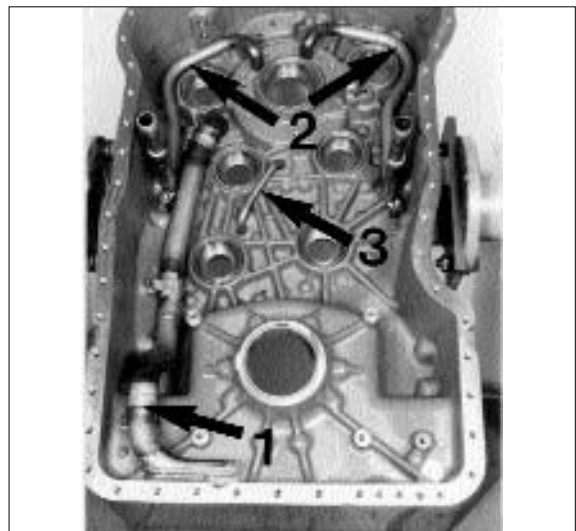

73073TM092

④ Locate both pressure pipes by means of special device.

※ Special tool

Tension bar 5870 654 030

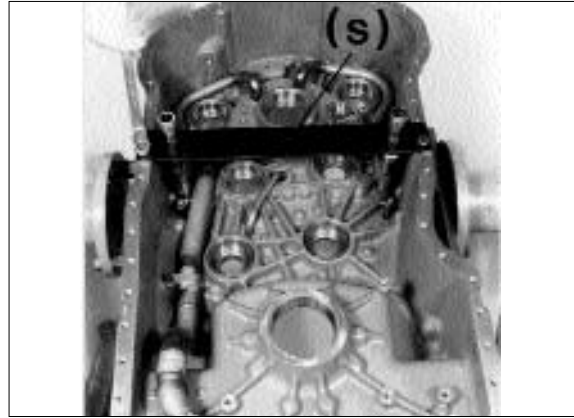

73073TM093

⑤ Tilt housing 180°.

Roll in suction tubes as well as pressure pipes (Arrows) into the housing bores, using special tool.

※ Pipe end of pressure pipes (Arrows) must be slightly below the housing plane face, if necessary equalize.

※ Special tool

Rolling tool 5870 600 003

Rolling tool 5870 600 004

Rolling tool 5870 600 005

Rolling tool 5870 600 006

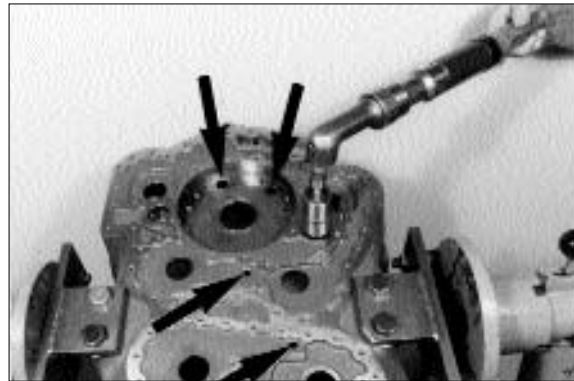

73073TM094

⑤ Tilt housing 180°.

Check installation position of the two pressure pipes and correct if necessary.

※ Pipes must be located in the special device without play and pressure.

Now, remove special device.

※ Special tool

Tension bar 5870 654 030

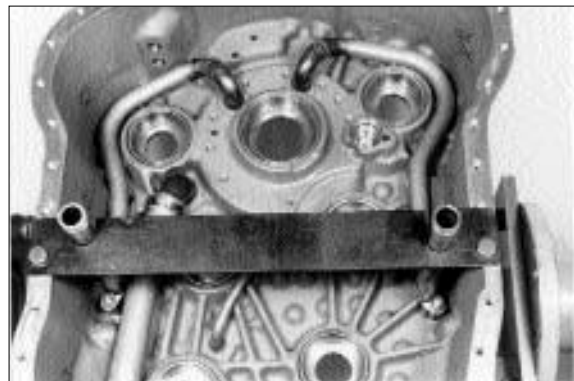

73073TM095

⑥ Equip screw plug with new O-ring and install it.

• Torque limit : 5.2kgf · m(37.6lbf · ft)



73073TM096

- ⑦ Insert all bearing outer races into the housing bore.
- ※ In the case that already run bearings are reused, pay attention to the allocation of the bearing outer races, see also Note, page 3-101.
 - ※ Pay attention to the corresponding markings.

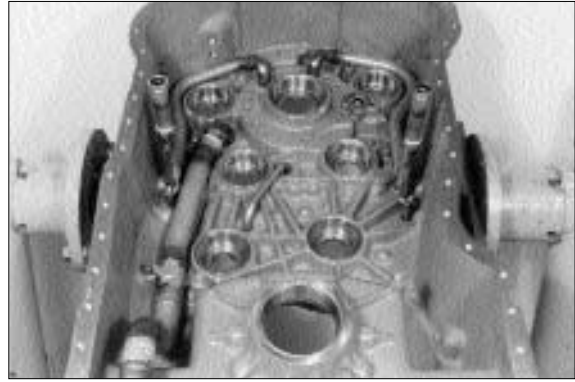

73073TM097

- ⑧ Insert both oil pipes(Arrows) into the housing cover, tilt housing cover 180° and roll in oil pipes into the housing bores.
- ※ The pipe end must be situated slightly below the housing plane face.
 - ※ Special tool
Rolling tool 5870 600 005

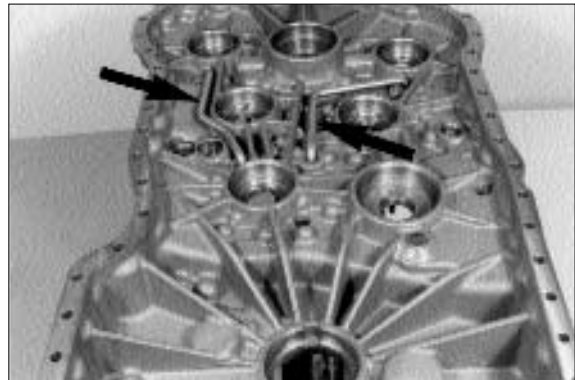

73073TM098

- ⑨ Install studs (M8 × 25, 27EA) according to the figure on the right.
- Torque limit : 0.92kgf · m(6.64lbf · ft)

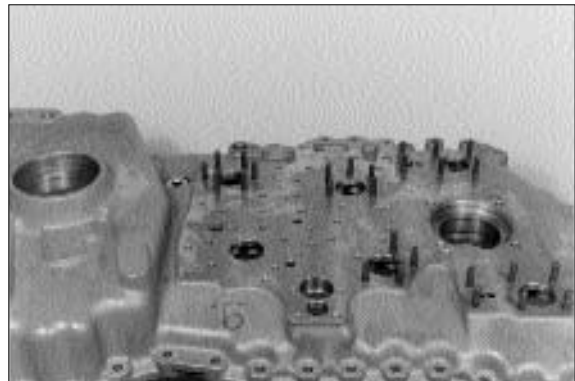

73073TM099

- ⑩ Insert set screws(2EA) into the housing bores(Arrows).

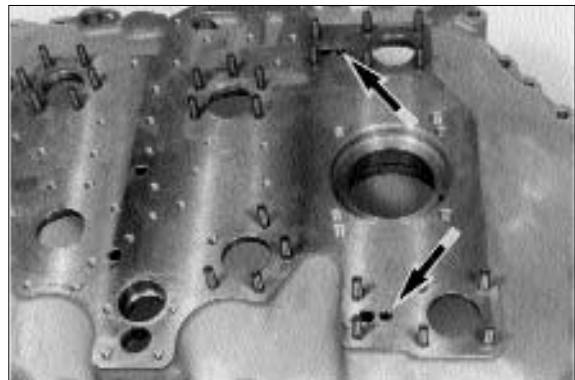

73073TM099A

Assemble KV and KR clutch

The following figures describe the assembly of the KV clutch.

Pre-assemble plate carrier(Figure ⑪~⑭)

⑪ Check function of the drain valve.

※ Ball may not seize, if necessary clean by means of compressed air.

Insert both O-rings(Arrows) scroll free into the recesses of the piston and oil

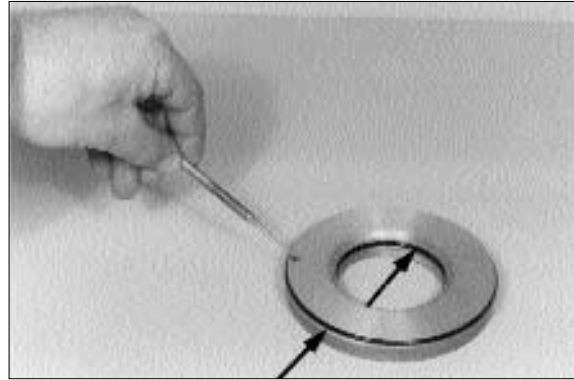

73073TM100

⑫ Assemble piston until contact is obtained.

※ Pay attention to the installation position, see on the right figure.



73073TM101

⑬ Introduce compression spring along with spring cup(2EA).



73073TM102

⑭ Preload compression spring and fix it by means of circlip.

※ Special tool

Assembly aid

5870 345 086



73073TM103

KV, KR plate pack

- ※ The plate equipment, respectively stacking of KV and KR clutch is identical. The following draft shows the installation position of the components.

- 1 Plate carrier
- 2 Piston
- 3 Outer plate-one-sided coated
- 4 Inner plates
- 5 Outer plates-coated on both sides
- 6 Snap ring(Optional s = 2.1~4.2mm)
- 7 End shim

- ※ Install outer plate 3 with the uncoated side facing the piston, respectively the end shim.

Install on the end shim side **two** outer and inner plates each.

- Effective number of friction surfaces =20.

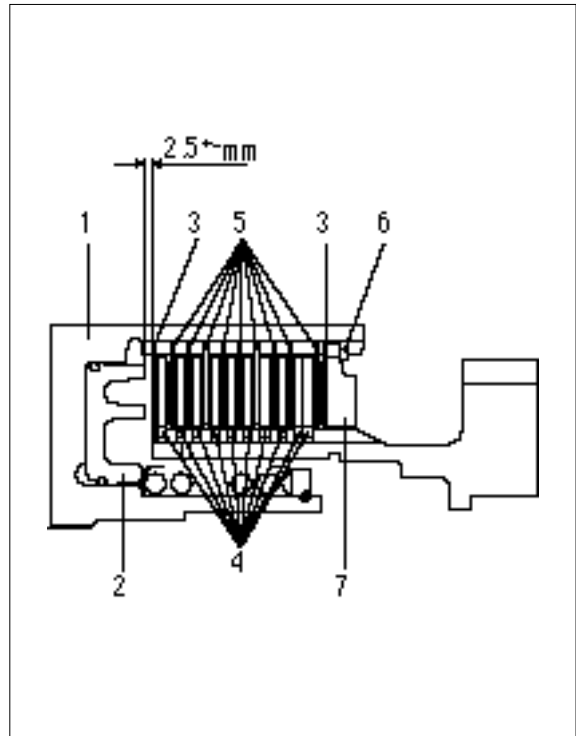

73033TM13

- ④ Adjust plate clearance = $2.5^{+0.2}$ mm.

- ※ For the adjustment of the plate clearance there are snap rings of different thickness available.

To ensure a faultless measuring result, install plates for the moment without oil.

- ※ Introduce plate pack according to the upper draft.



73073TM105

- ⑩ Mount end shim and squeeze snap ring (e.g. $s = 3.0\text{mm}$) in.



73073TM106

- ⑪ Press end shim on with about 10kg and measure Dimension I from the end face/plate carrier to the end shim.

Dimension I e.g. 7.25mm

※ Special tool

Digital-Depth gauge 5870 200 072



73073TM107

- ⑫ Press end shim against snap ring (Upward) until contact is obtained and determine Dimension II.

Dimension II e.g. 4.75mm

※ Special tool

Digital-Depth gauge 5870 200 072



73073TM108

EXAMPLE

Dimension I 7.25mm

Dimension II - 4.75mm

Difference = Plate clearance = 2.50mm

- ※ In case of deviations from the required plate clearance, correct by means of corresponding snap ring ($s = 2.1\sim 4.2\text{mm}$).
Now, remove plate pack, oil and install it again.

- ⑲ Introduce idler gear until all inner plates are accommodated.
※ This step makes the later assembling of the idler gear easier.
Now, remove idler gear again.



73073TM109

- ⑳ Install stud(Arrow).
Use Loctite.
※ · Torque limit : 1.73kgf · m(12.5lbf · ft)



73073TM110

Insert ball bearing until contact is obtained and fix it by means of circlip.



73073TM111

Assemble needle bearing.



73073TM112

- Press idler gear against shoulder.
※ Support it on the bearing inner race.



73073TM113

- Fix idler gear axially by means of circlip.
※ At KR clutch there is no recess in the shaft-assembly circlip until contact on the bearing inner race is obtained.
※ Special tool
Set of internal pliers 5870 900 013



73073TM114

- Assemble pre-assembled plate carrier until contact is obtained.
※ Only if the plate carrier plane face is overlapping with the shaft collar, the accommodation of all inner plates is ensured, see on the below figure.



73073TM115

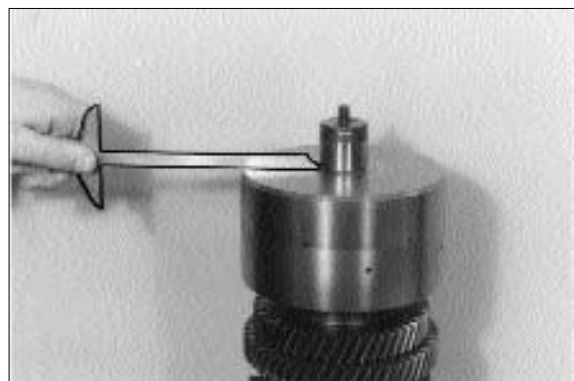

73073TM116

Press tapered roller bearing against shoulder.
Install opposite tapered roller bearing.



73073TM117

Check function of clutch by means of compressed air.

- ※ At correctly installed components, the closing, respectively opening of the clutch is clearly audible.



73073TM118

(2) Assemble K1, K2 and K3 clutch

- ※ The following figures describe the assemble of the K3 clutch.

The assembly of the K1 and K2 clutches has to be carried out accordingly.

① Install stud(Arrow).

- ※ Use Loctite.

· Torque limit : 1.73kgf · m(12.5lbf · ft)



73073TM125

② Assemble plate carrier until contact is obtained.



73073TM126

- ③ Check function of the drain valve.
 ※ Ball may not seize, if necessary clean by means of compressed air.
 Insert both O-rings(Arrows) scroll free into the piston recesses and oil them.

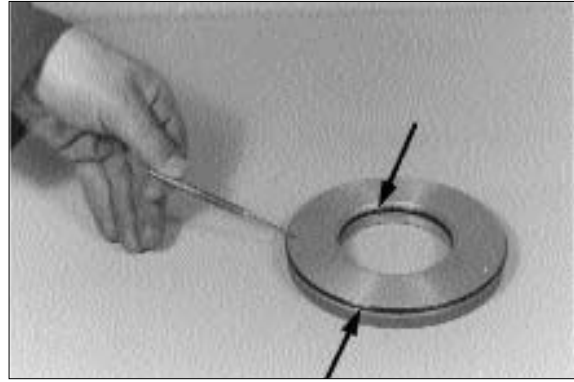

73073TM127

- ④ Introduce piston until contact is obtained.
 ※ Pay attention to the installation position, see on the right figure.



73073TM128

- ⑤ Introduce compression spring along with spring cup(2EA).



73073TM129

- ⑥ Preload compression spring and fix it by means of circlip.
 ※ Special tool
 Assembly aid(K2 and K3) 5870 345 085
 Assembly aid(K1) 5870 345 086



73073TM130

K1, K2 and K3 plate pack

- ※ The K1, K2 and K3 plate stacking of clutches are identical.

The following draft shows the installation position of the components.

- 1 Plate carrier
- 2 Piston
- 3 Outer plate-one-sided coated
- 4 Inner plates
- 5 Outer plates-coated on both sides
- 6 Snap ring(Optional $s = 2.1 \sim 4.2\text{mm}$)
- 7 End shim

- ※ Install outer plate 3 with the uncoated side facing the piston.
 - Effective number of the friction surfaces = 16.

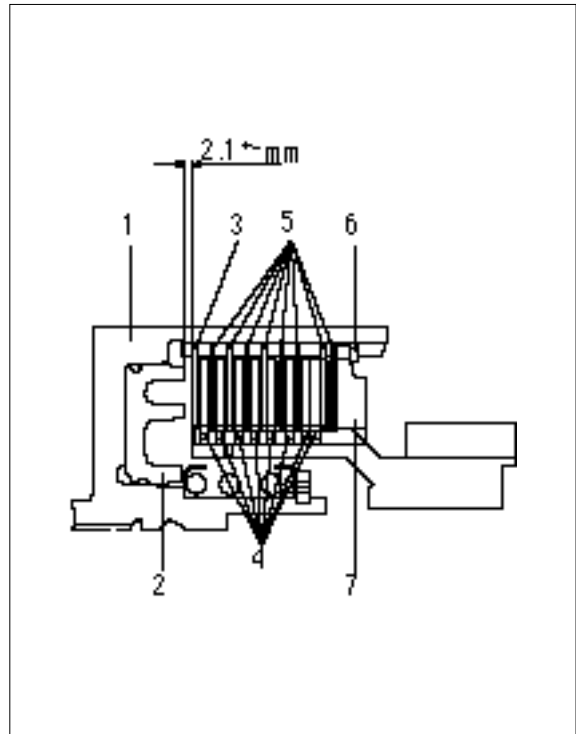

73033TM15

- ⑦ Adjust plate clearance = $2.1^{+0.2}\text{mm}$:

- ※ For the plate clearance adjustment there are snap rings of different thickness available.

To ensure a faultless measuring result, install the plates for the moment without oil.

- ※ Introduce plate pack according to the upper draft.



73073TM135

- ⑧ Fit end shim and squeeze snap ring(e.g. 3.0mm) in.



73073TM136

- ⑨ Press end shim on with about 10kg, and measure Dimension I from the end face/plate carrier to the end shim.

Dimension I e.g. 8.20mm

※ Special tool

Digital-Depth gauge 5870 200 072



73073TM137

- ⑩ Press end shim against snap ring(Upward) until contact is obtained, and determine Dimension II .

Dimension II e.g. 6.00mm

※ Special tool

Digital-Depth gauge 5870 200 072



73073TM138

EXAMPLE :

Dimension I e.g. 8.20mm

Dimension II e.g. - 6.00mm

Difference = Plate clearance = 2.20mm

- ※ In case of deviations from the required plate clearance, correct by means of corresponding snap ring(S =2.1~4.2mm).
※ Now, demount plate pack, oil and install it again.

- ⑪ Assemble running disk 1(50×70×4), axial needle cage 2 and axial washer 3 (50×70×1).

※ Install running disk 1 with the chamfer facing the axial needle cage.



73073TM139

⑫ Assemble both needle bearings.



73073TM140

⑬ Introduce idler gear until all inner plates are accommodated.



73073TM141

⑭ Assemble axial washer 3(50×70×1), axial needle cage 2 and running disk 1 (50×70×4).

- ※ Install running disk 1 with the chamfer facing the axial needle cage.
- ※ Only if the running disk is overlapping with the shaft collar, the accommodation of all inner plates is ensured.

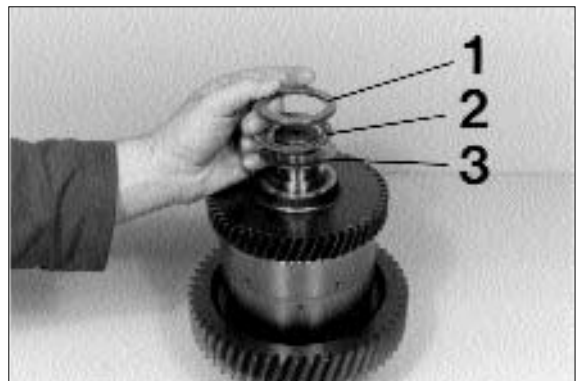

73073TM142

⑮ Press tapered roller bearing against shoulder.



73073TM143

- ⑩ Press tapered roller bearing against shoulder.



73073TM144

- ⑪ Check function of the clutch by means of compressed air.

※ At correctly installed components, the closing, respectively opening of the clutch is clearly audible.



73073TM145

(3) Assemble K4 clutch

- ① Undercool shaft (About -80°C), heat gear (About $+120^{\circ}\text{C}$) and assemble it until contact is obtained.



73073TM150

- ② Locate gear axially by means of circlip.

※ Special tool

Set of external pliers 5870 900 015



73073TM151

③ Install stud(Arrow).

※ Use Loctite.

· Torque limit : 1.73kgf · m(12.5lbf · ft)



73073TM152

④ Check function of the drain valve.

※ Ball may not seize, if necessary clean by means of compressed air.

Insert both O-rings(Arrows) scroll free into the piston recesses and oil them.

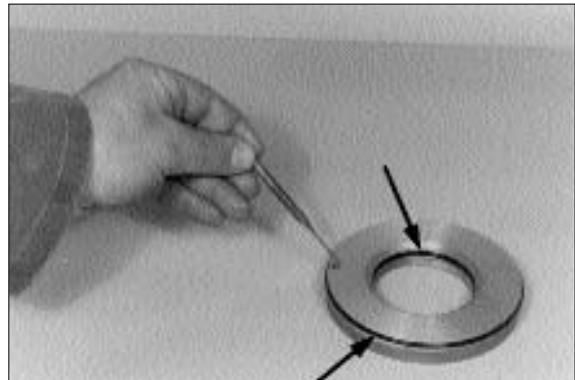

73073TM153

⑤ Introduce piston until contact is obtained.

※ Pay attention to the installation position, see on the right figure.



73073TM154

⑥ Install compression spring and spring cup(2EA), preload and fix by means of circlip.

※ Special tool

Assembly aid

5870 345 085



73073TM155

K4 plate pack

The following draft shows the installation position of the components.

- 1 Plate carrier
- 2 Piston
- 3 Outer plate-one-sided coated
- 4 Inner plates
- 5 Outer plates-coated on both sides
- 6 Snap ring(Optional $s = 2.1\sim 4.2\text{mm}$)
- 7 End shim

- ※ Install outer plate 3 with the uncoated side facing the piston.
 - Effective number of friction surfaces = 10.

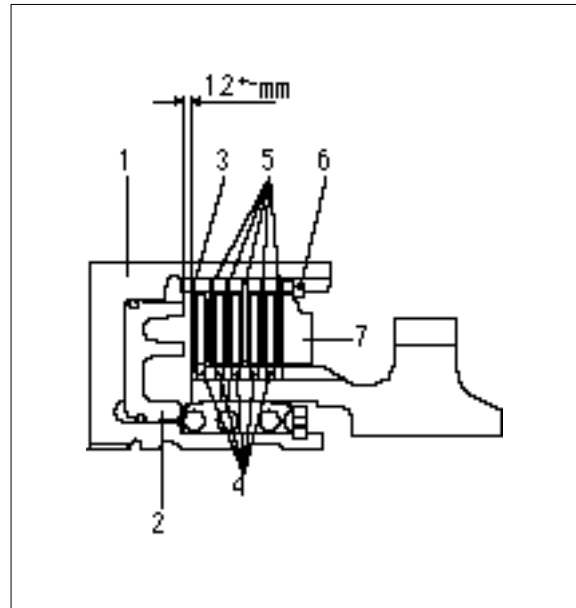

73033TM16

- ⑦ Adjust plate clearance = $1.2^{+0.2}\text{mm}$:

- ※ For the plate clearance adjustment there are snap rings of different thickness available.

To ensure a faultless measuring result, install the plates for the moment without oil.

Introduce plate pack according to the draft(See the preceding page).

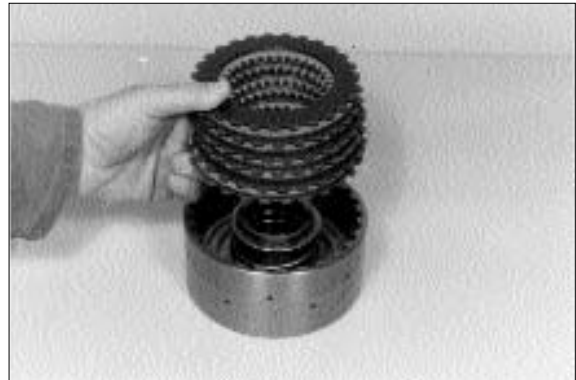

73073TM160

- ⑧ Fit end shim and squeeze circlip(e.g. $s = 3.0\text{mm}$) in.



73073TM161

- ⑨ Press end shim on with about 10kg and measure Dimension I from the end face/plate carrier to the end shim.

Dimension I e.g. 7.20mm

※ Special tool

Digital-Depth gauge 5870 200 072



73073TM162

- ⑩ Press end shim against snap ring (Upward) until contact is obtained and determine Dimension II.

Dimension II e.g. 6.00mm

※ Special tool

Digital-Depth gauge 5870 200 072

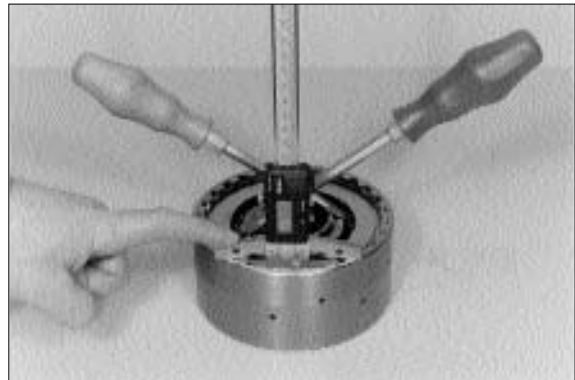

73073TM163

EXAMPLE

Dimension I e.g. 7.20mm

Dimension II e.g. - 6.00mm

Difference = Plate clearance = 1.20mm

- ※ In case of deviations from the required plate clearance, correct by means of corresponding snap ring(S = 2.1~4.2mm).

- ⑪ Introduce idler gear until all inner plates are accommodated.

- ※ This step makes the later assembling of the idler gear easier.

Now, remove idler gear again.



73073TM164

- ⑫ Assemble both axial washers as well as needle cage.
※ Upper and lower axial washer have the same thickness(50×70×1).



73073TM165

- ⑬ Assemble both needle bearings.



73073TM166

- ⑭ Assemble idler gear.



73073TM167

- ⑮ Assemble axial washer 3(50×70×1) needle cage 2 and running disk 1(50×70×4).
※ Install running disk 1 with the chamfer facing the needle cage.

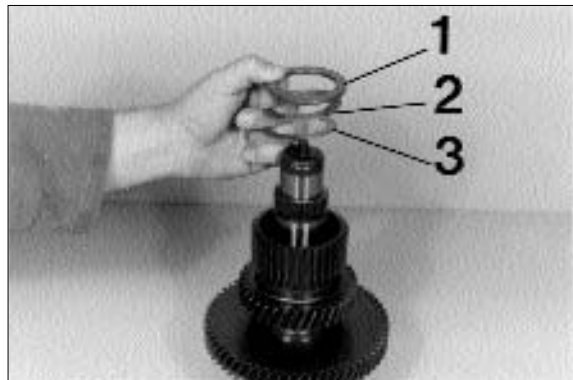

73073TM168

- ⑩ Assemble pre-assembled plate carrier until all inner plates are accommodated.



73073TM169

- ⑪ Fix plate carrier axially by means of circlip.

※ Special tool

Set of external pliers 5870 900 015

Handle 5870 260 010



73073TM170

- ⑫ Press tapered roller bearing against shoulder.
Install opposite tapered roller bearing.



73073TM171

- ⑬ Check function of the clutch by means of compressed air.

※ At correctly installed components, the closing, respectively opening of the clutch is clearly audible.



73073TM173

(4) Pre-assemble input shaft

- ① Undercool the input shaft(About -80°C), heat gear(About $+120^{\circ}\text{C}$) and assemble it until contact is obtained.



73073TM174

- ② Fix gear axially by means of circlip.



73073TM175

- ③ Squeeze snap ring into the recess of the turbine shaft.



73073TM176

- ④ Introduce turbine shaft until the snap ring snaps into the recess of the input shaft-turbine shaft is axially fixed.



73073TM177

- ⑤ Press both bearing inner races against shoulder.



73073TM178

- ⑥ Install ball bearing.
Squeeze rectangular ring (Arrow) in and hook it in.



73073TM179

- ⑦ Insert output shaft into the housing bore until contact is obtained.



73073TM180

(5) Install pre-assembled output shaft and clutches

※ The following figures describe the **common** installation of all clutches.

For it, the housing cover, combined with special tool is needed.

The assembly of single clutches without housing cover and handles is extremely difficult because of the installation conditions.

⚠ Besides, there is the danger of injury.

① Insert all bearing outer races into the housing cover until contact is obtained.

※ In the case that already run bearings are reused, pay attention to the allocation of the bearing outer races, see also Note, page 3-105.

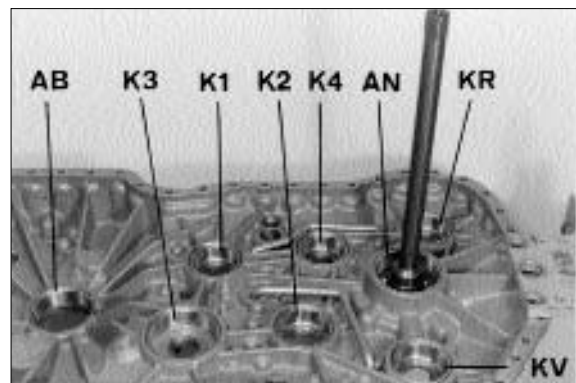

② Insert KR clutch, input shaft and KV clutch together into the housing cover.

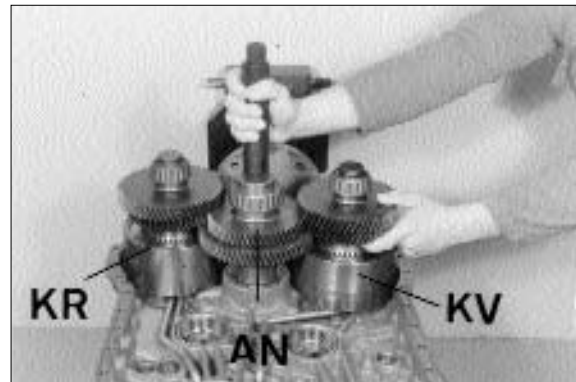

③ Install K4 clutch.



④ Install K3 clutch.



⑤ Position K1 clutch.



⑥ Insert K2 clutch.

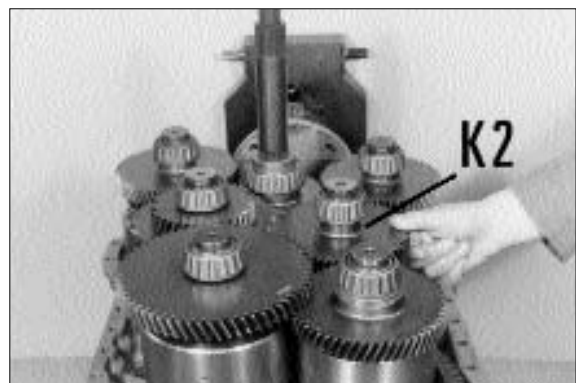

⑦ Figure on the right shows the installation position of the single clutches in the housing cover.

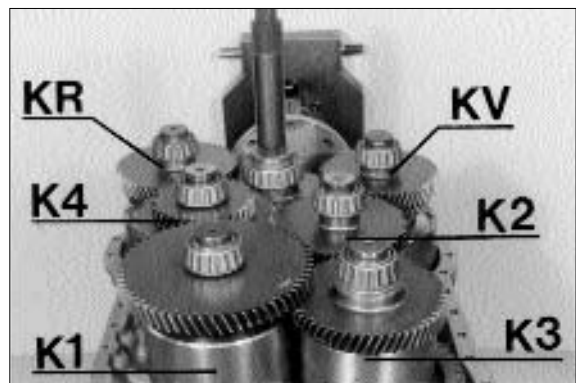

- ⑧ Locate all clutches by means of handles.
- ※ Special tool
Handle(6EA needed) 5870 260 010

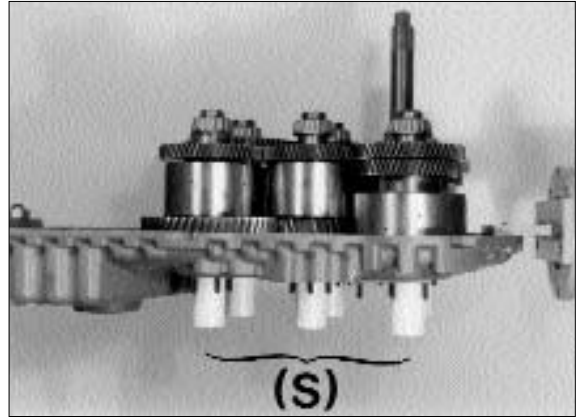

73073TM197

- ⑨ Squeeze rectangular rings(7 pieces, see Arrows) in and hook them in.
Now, grease rectangular rings and align them centrally.

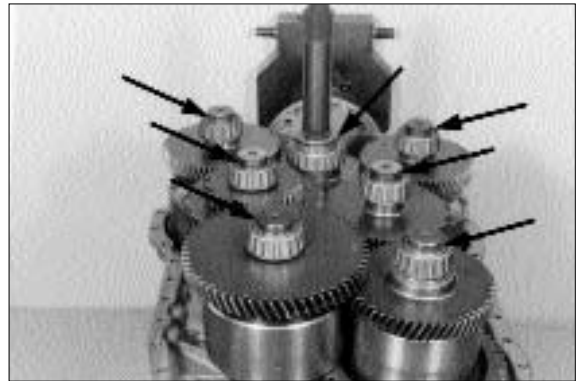

73073TM198

- ⑩ Tilt housing cover 180° .
Mount eye bolts, see Arrows.
- ※ Special tool
Eye bolt M20(2EA) 0636 804 003
Eye bolt M16(1EA) 0636 804 001
Puller device 5870 000 017



73073TM199

- ⑪ Install adjusting screws.
- Position housing cover by means of lifting device carefully on the gearbox housing until contact is obtained, respectively position the clutches in the gearbox housing.
- ※ Pay attention to the overlapping of the oil pipes with the bores in the housing cover.
- ※ Special tool
Lifting chain 5870 281 047
Adjusting screws 5870



73073TM200

⑫ Remove handles again.

※ Special tool

Lifting chain

5870 281 047

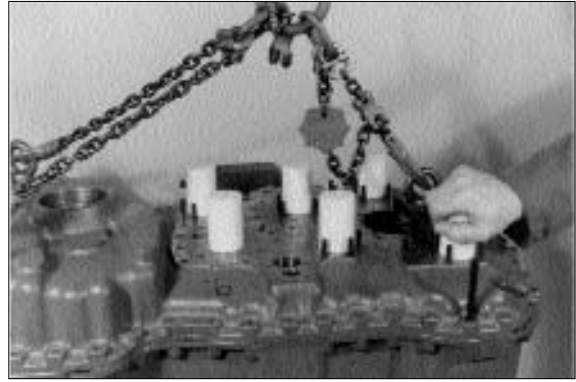

73073TM201

⑬ Separate housing cover from gearbox housing, using lifting device.

※ Special tool

Lifting chain

5870 281 047

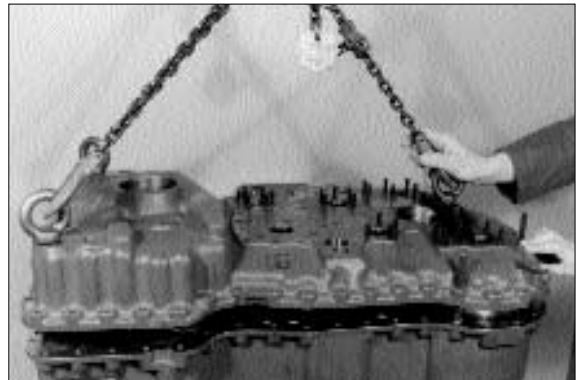

73073TM202

(6) Output

① Assemble sheet and press both bearing inner races against shoulder until contact is obtained.



73073TM203

② Insert bearing outer race (Arrow) into the housing bore until contact is obtained.



73073TM204

③ Position screening plate.

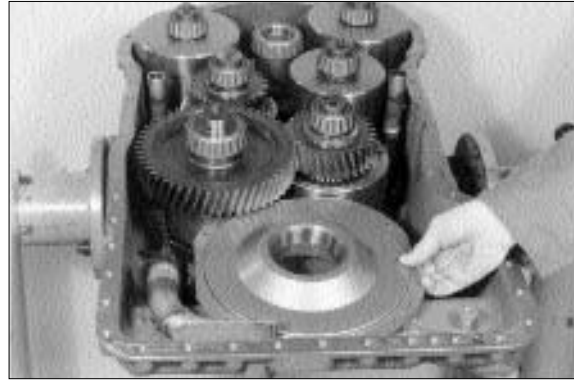

73073TM205

④ Insert output shaft.



73073TM206

⑤ Fasten both sheets by means of socket head screws(4EA).

- ※ Insert socket head screws with Loctite.
- Torque limit : 2.35kgf · m(17.0lbf · ft)



73073TM207

⑥ Squeeze rectangular rings(6EA) into the recesses of the clutch shafts and hook them in.

Now, grease rectangular rings and align them centrally.



73073TM208

- ⑦ Insert both O-rings(Arrows) into the annular groove of the oil pipes and grease them.



73073TM209

- ⑧ Cover mounting face with sealing compound Loctite.
Install adjusting screws(S) and position housing cover carefully against gearbox housing until contact is obtained, using lifting device.

※ Pay attention to the overlapping of the oil pipe with the bores in the housing cover.

※ Special tool

Adjusting screws 5870 204 007

Lifting chain 5870 281 047



73073TM210

- ⑨ Install both cylindrical pins.



73073TM211

- ⑩ Fasten housing cover by means of hexagon head screws.

· Torque limit : 4.69kgf · m(33.9lbf · ft)

※ Pay attention to the position of the fixing plate, see Arrow.

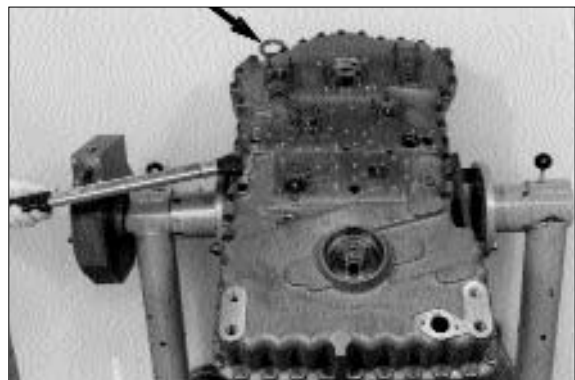

73073TM212

⑪ Install shaft seal, with the sealing lip facing the oil chamber.

※ By application of the prescribed driver, the exact installation position is obtained.
Wet rubber-coated outer diameter with spirit.

Grease sealing lip.

※ Special tool

Driver 5870 048 057

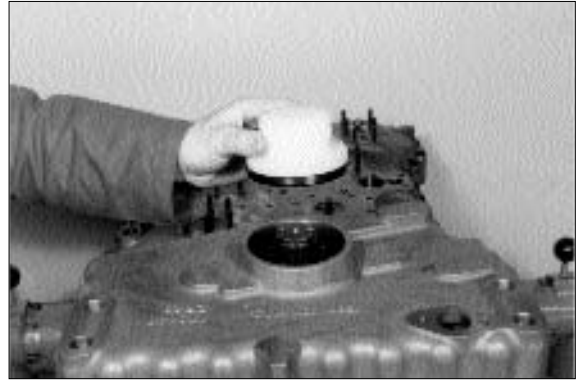

73073TM213

⑫ Heat the output flange(Maximum 90°C), assemble it and fix it by means of washer and hexagon head screws.

※ Wet contact area of washer with sealing compound Loctite.

· Torque limit : 3.47kgf · m(25.1lbf · ft)

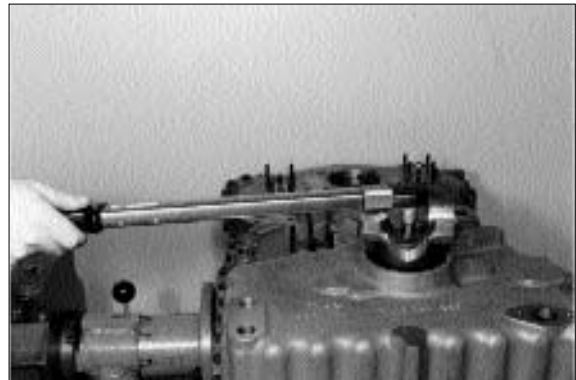

73073TM214

⑬ Fix hexagon head screws by means of lock plate.

Install output flange on the converter side accordingly(Figure ⑪~⑬).

※ Special tool

Driver 5870 057 011

Handle 5870 260 002



73073TM215

(7) Converter pressure valve

① The illustration on the right shows the components of the converter pressure valve.

- 1 Piston
- 2 Compression spring
- 3 Valve insert
- 4 Roll pin

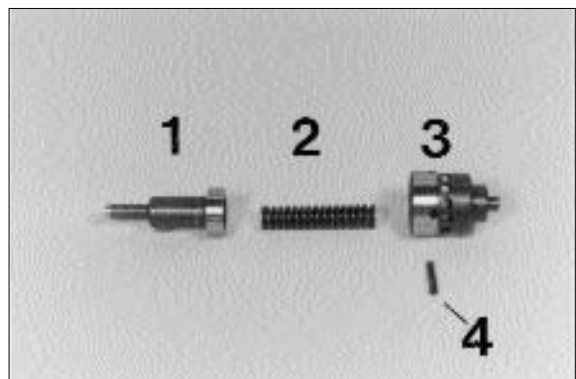

73073TM220

- ② Introduce compression spring and piston, preload and fix them by means of roll pin.

※ Special tool

Assembly aid

5870 345 084

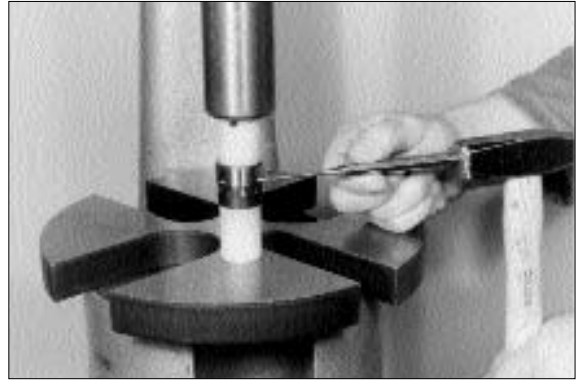

73073TM221

- ③ Insert pre-assembled converter pressure valve into the housing bore.

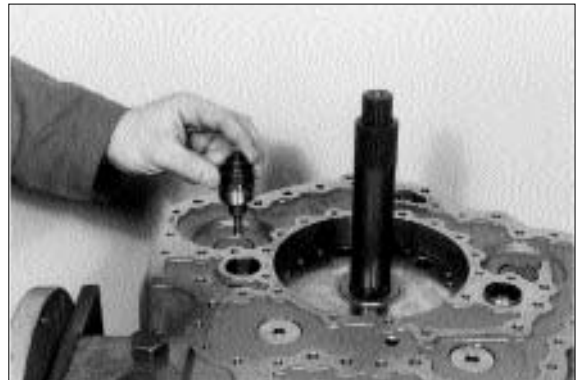

73073TM222

(8) Oil feed housing-Transmission pump

- ① Install two adjusting screws (Arrows) and mount flat gasket.

※ Special tool

Adjusting screws

5870 204 011



73073TM223

- ② Mount oil feed housing and fix it provisionally by means of washers and hexagon head screws.

※ Screw the hexagon head screws in only until contact is obtained-**do not tighten**.

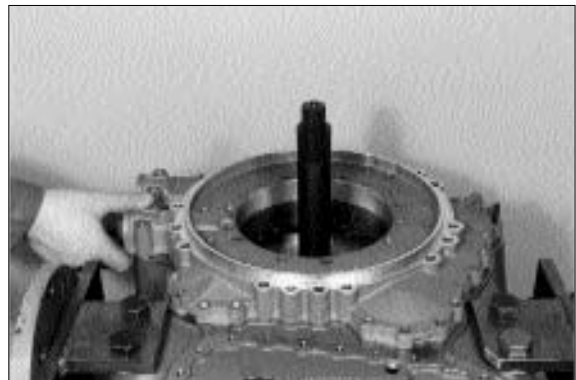

73073TM224

- ③ Install two adjusting screws and introduce stator shaft until contact is obtained.
- ※ Pay attention to the overlapping of the bores.
 - ※ Special tool
Adjusting screws 5870
204 007

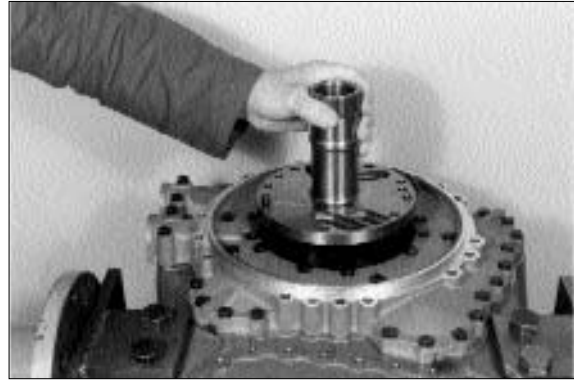

73073TM225

- ④ Install O-ring(Arrow) and oil it.

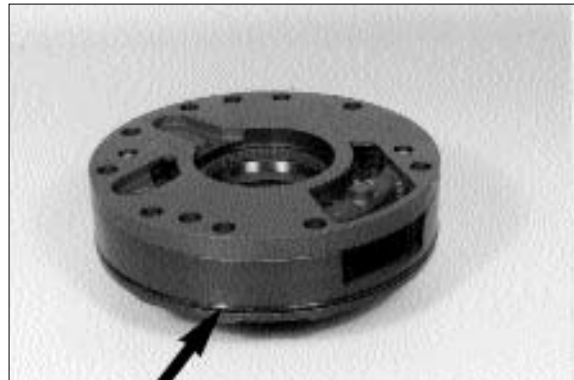

73073TM226

- ⑤ Introduce transmission pump until contact is obtained.
- ※ Pay attention to the overlapping of the bores.

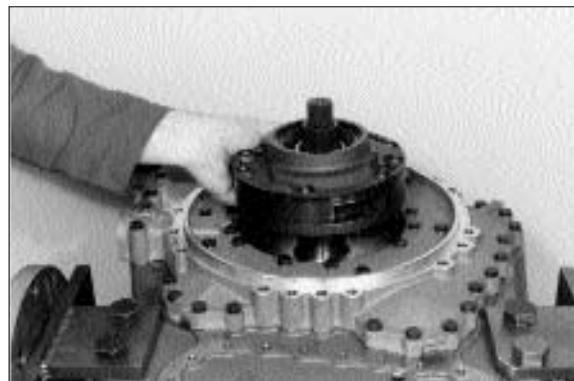

73073TM227

- ⑥ Equip socket head screws with new O-rings(Arrow).
- ※ Grease O-rings.

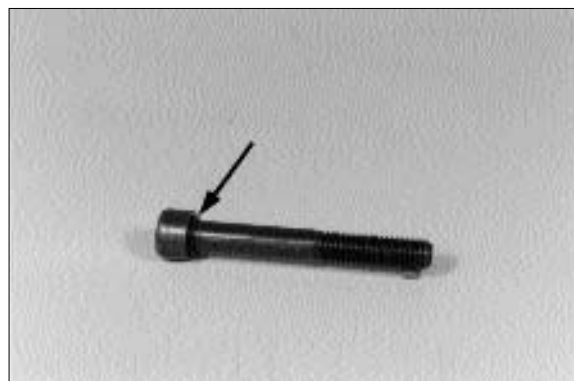

73073TM228

- ⑦ Fasten transmission pump by means of socket head screws.
· Torque limit : 4.69kgf · m(33.9lbf · ft)

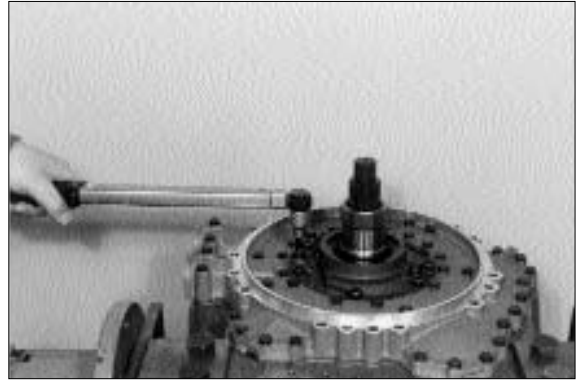

- ⑧ Fix oil feed housing finally by means of hexagon head screws(Mount flat washers).
· Torque limit : 2.55kgf · m(18.4lbf · ft)
※ Pay attention to the installation position of the fixing plate(Arrow), see the next figure.

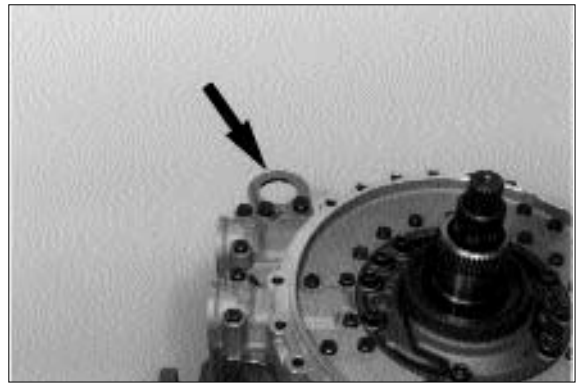
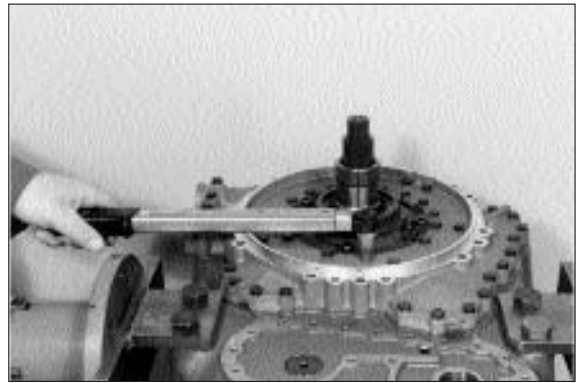

- ⑨ Fit flat gasket and fasten cover by means of hexagon head screws.
· Torque limit : 2.35kgf · m(17.0lbf · ft)



(9) Engine connection-Converter

- ① Fasten converter housing by means of hexagon head screws.
· Torque limit : 6.93kgf · m(50.2lbf · ft)



73073TM233

- ② Fasten input shaft, membrane and disk by means of hexagon head screws.
· Torque limit : 11.7kgf · m(84.8lbf · ft)



73073TM234

- ③ Fasten membrane on the converter, using hexagon head screws(Mount flat washers).
· Torque limit : 11.7kgf · m(84.8lbf · ft)
※ Insert hexagon head screws with Loctite.



73073TM235

- ④ Introduce converter until contact is obtained.
※ Impulse disk of the converter must be centrally to the bore of the inductive transmitter, see on the below figure.
Only in this way it is ensured that the converter has been completely introduced.



73073TM236

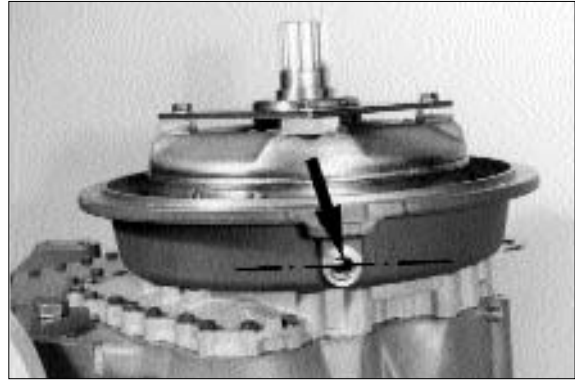

73073TM237

- ⑤ Insert ball bearing until contact is obtained and fix it by means of circlip.

※ Special tool

Set of internal pliers 5870 900 013



73073TM238

- ⑥ Assemble housing cover.

Install input flange, fit disk and pull cover by means of hexagon head screws evenly against shoulder.

※ Pay attention to the radial installation position of the cover.



73073TM239

- ⑦ Fasten cover by means of hexagon head screws and nuts on the converter housing.

· Torque limit : 4.69kgf · m(33.9lbf · ft)



73073TM240

- ⑧ Fasten input flange finally and fix hexagon head screws by means of lock plate.

• Torque limit : 3.47kgf · m(25.1lbf · ft)

※ Special tool

Driver 5870 057 010

Handle 5870 260 002



73073TM241

(10) Converter safety valve

- ① The illustration on the right shows the components of the converter safety valve.

- 1 Plate
- 2 Ball
- 3 Compression spring
- 4 Valve insert
- 5 Valve sleeve
- 6 Cylindrical pin

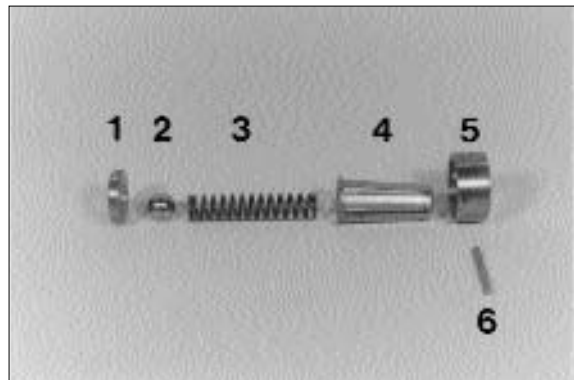

73073TM245

- ② Assemble components according to figure ①, preload and fix by means of cylindrical pin.

※ Special tool

Assembly aid 5870 345 084



73073TM246

- ③ Insert converter safety valve into the housing bore until contact is obtained.

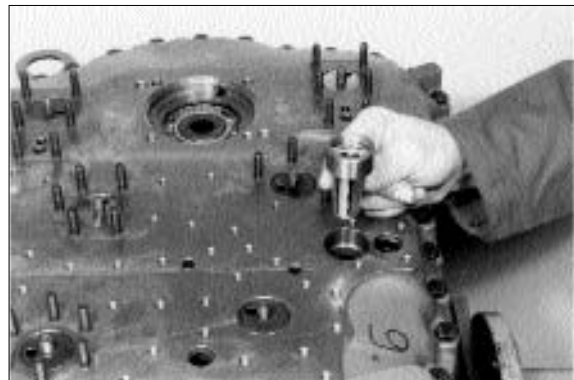

73073TM247

(11) Fit duct plate

- ① Install both screw plugs(Arrows),
- ※ Install new sealing rings.

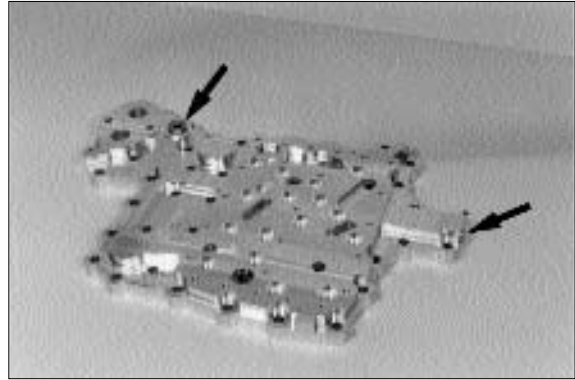

73073TM248

- ② Install gasket, place duct plate against shoulder and fasten it by means of socket head screws and hexagon nuts(Mount flat washers).

· Torque limit : 2.55kgf · m(18.4lbf · ft)

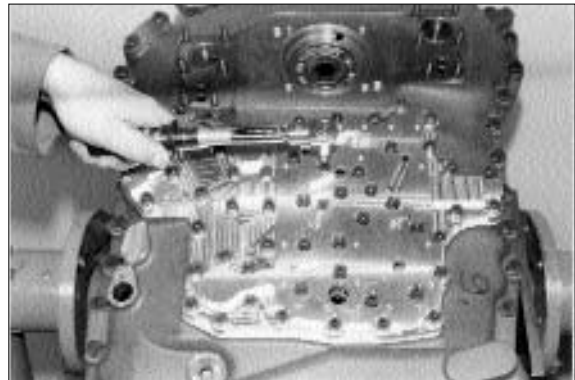

73073TM249

(12) Fit hydraulic control unit

- ① Install two adjusting screws.
Mount gasket 1, intermediate plate 2 and gasket 3.
- ※ Pay attention to the installation position of the different gaskets, see also the following draft.
- ※ Special tool
Adjusting screws 5870 204 031

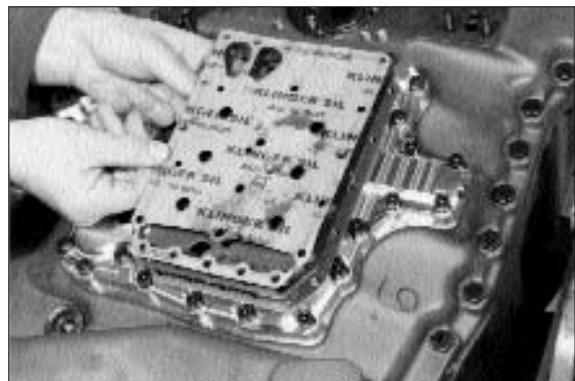

73073TM250

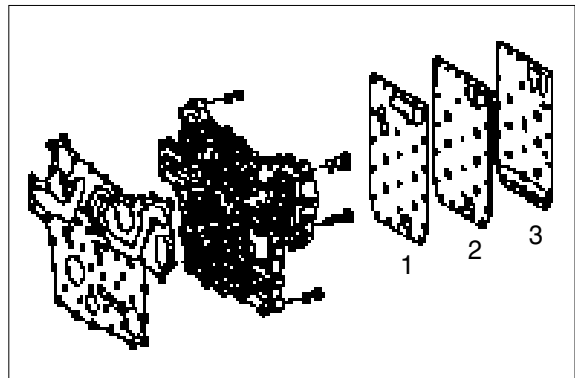

3-135(4) (740-7)

- ② Fasten complete control unit on the duct plate, using socket head screws.
· Torque limit : 0.97kgf · m(7.01lb · ft)

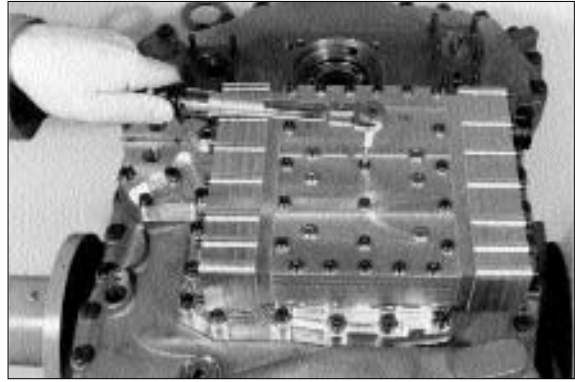

73073TM251

(13) Filter

- ① The illustration on the right shows the components of the filter unit.
※ Install new O-rings(Arrows)

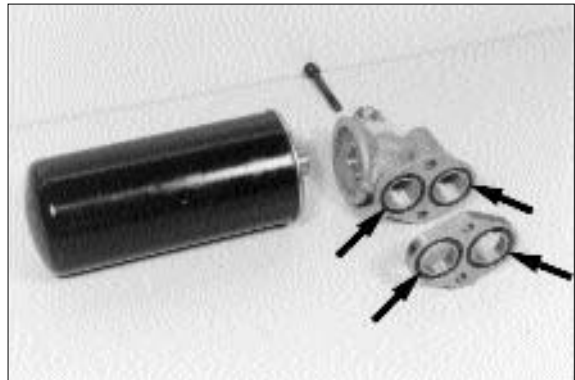

73073TM252

- ② Fasten intermediate plate and filter head by means of hexagon head screws (Mount flat washers).
· Torque limit : 2.55kgf · m(18.4lb · ft)

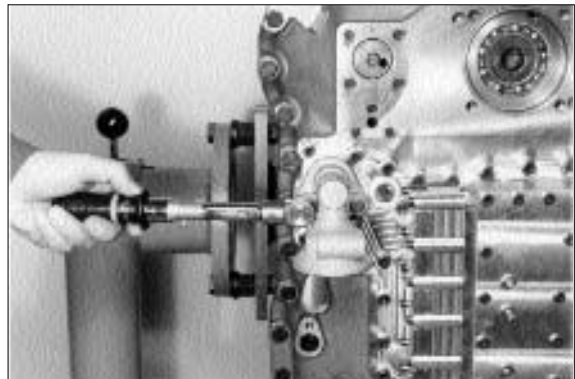

73073TM253

- ③ Oil gasket and tighten exchange filter hand-tight.



73073TM254

- ④ If necessary, install warning switch
(According to the version).

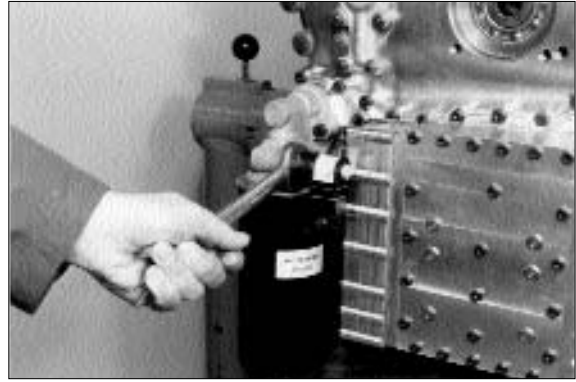

73073TM255

- ⑤ Insert O-ring(Arrow) into the annular groove of the oil feed covers.



73073TM256

- ⑥ Fasten the two covers(Arrows) by means of hexagon nuts(Mount flat washers) on the housing.
· Torque limit : 2.55kgf · m(18.4lbf · ft)

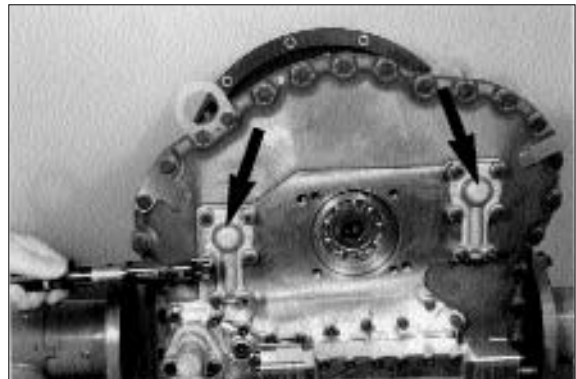

73073TM257

- ⑦ Mount oil level tube.
Install screw plug(Arrow).
※ Install new gaskets.
· Torque limit : 2.35kgf · m(17.0lbf · ft)
· Torque limit(Screw plug M26 × 1.5) :
8.16kgf · m(59.0lbf · ft)

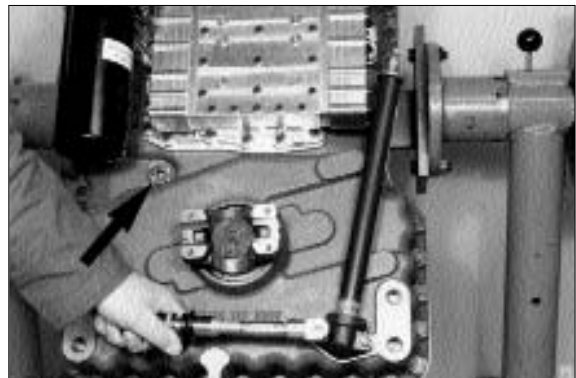

73073TM258

(14) Speed sensor and inductive transmitter

Grease O-ring, introduce speed

- ① sensor(Arrow) and fasten it by means of socket head screw.

· Torque limit : 2.35kgf · m(17.0lbf · ft)

34 Speed-output and -speedometer

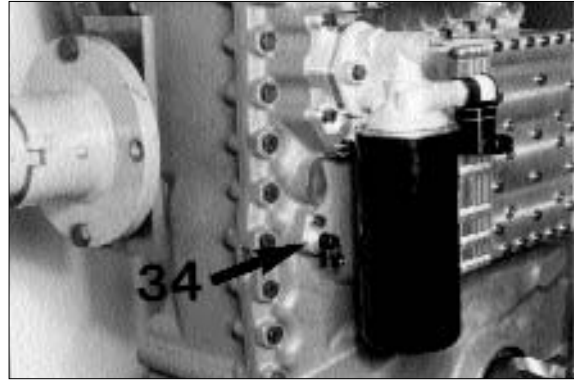

73073TM259

- ② Equip the inductive transmitters with new O-rings and install them.

· Torque limit : 3.06kgf · m(22.1lbf · ft)

48 Speed-engine

47 Speed-central gear train

21 Speed-turbine

Install breather(Arrow).

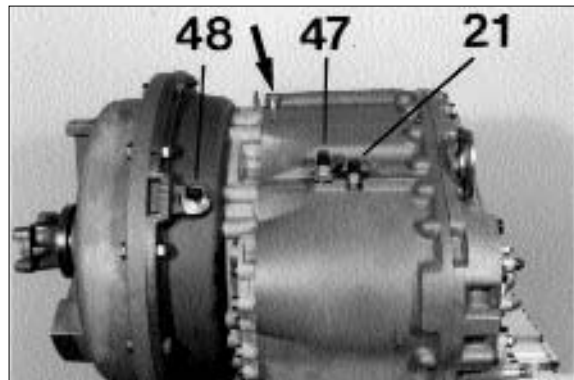

73073TM260

- ③ Install gasket and cover plate, arrow 1.

· Torque limit : 2.35kgf · m(17.0lbf · ft)

Equip screw plug(Arrow 2) with new O-ring and install it.

· Torque limit : 14.3kgf · m(103.3lbf · ft)

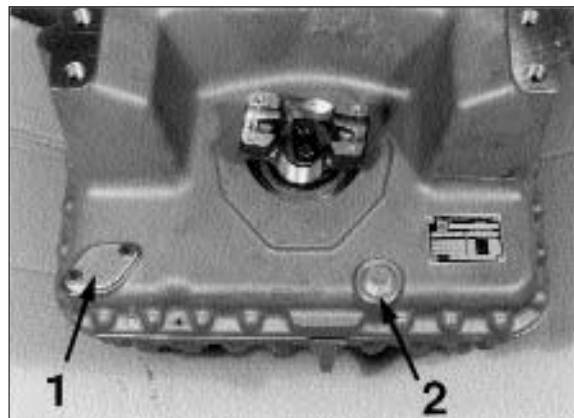

73073TM261

3. AXLE

1) BRAKES

WEAR CHECK AND REPLACEMENT OF BRAKE DISCS

(1) Use till minimum thickness of $s = 4.5\text{mm}$.

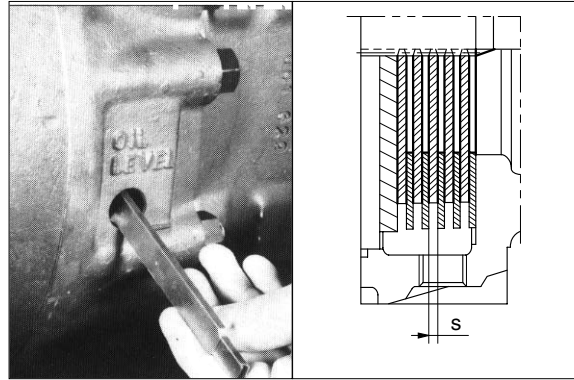

(2) Loose fixing nuts and remove horizontally the axle housing.

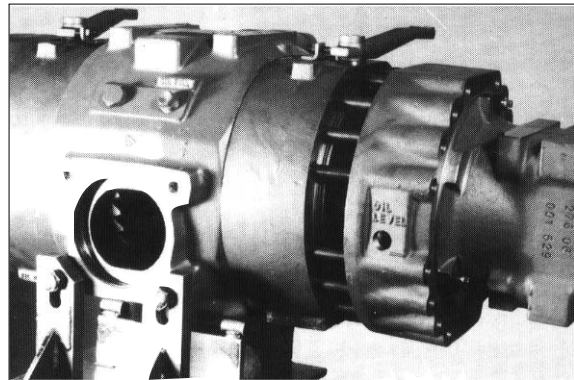

(3) Remove brake discs.

※ If the brake discs must not be replaced, remove the complete pack without changing the position of the discs.

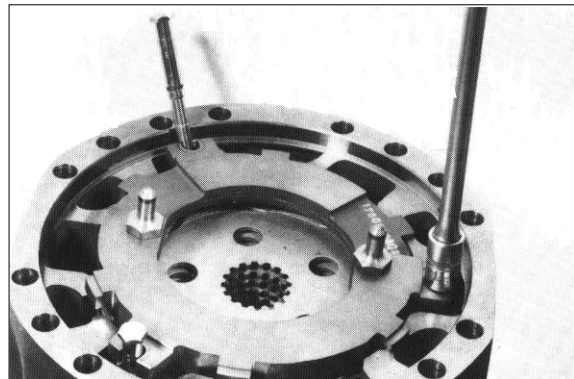

(4) For assembling proceed in opposite sense, align lubrication holes.

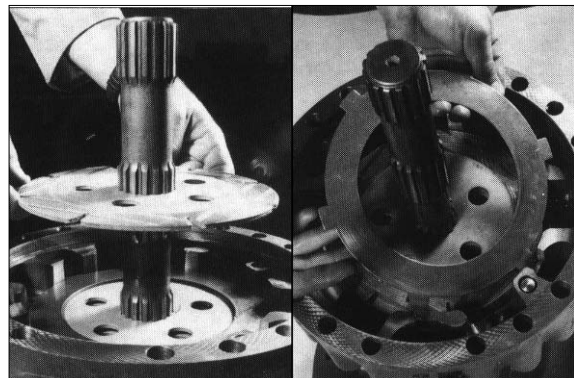

- (5) Adjustment of brake disc gap. Adjusting bolts counterclockwise and turn them a 3/4 revolution clockwise ; This corresponds to a gap of 0.75mm between the brake discs.

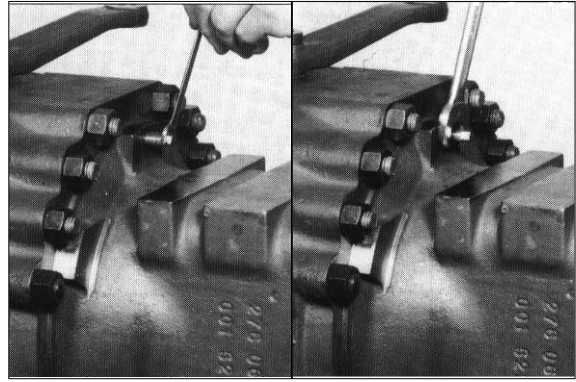

- (6) Remove brake pistons.

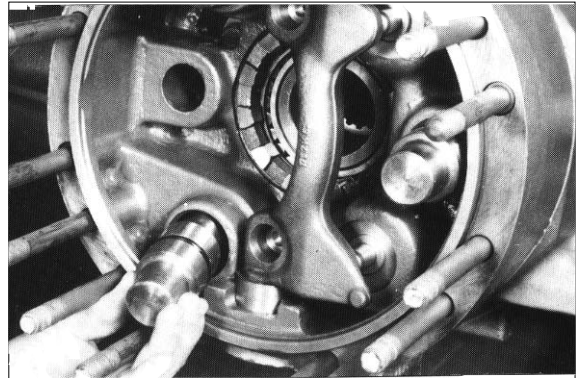

- (7) Install O-rings and brake pistons.
※ Observe that neither the pistons nor the cylinders have scratches or incrostations.

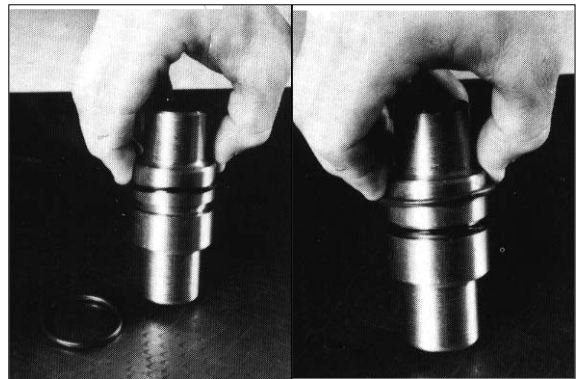

- (8) Tight checking with compressed air at 0.5~1bar for 10 minutes each side.

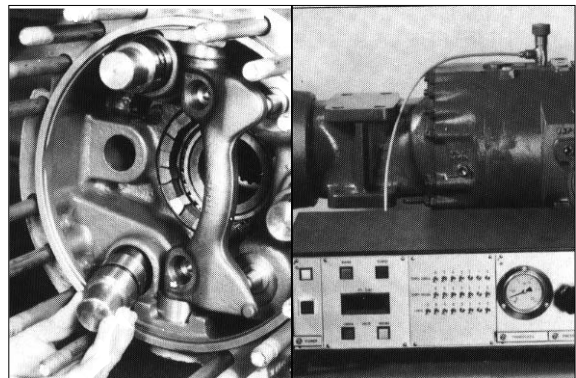

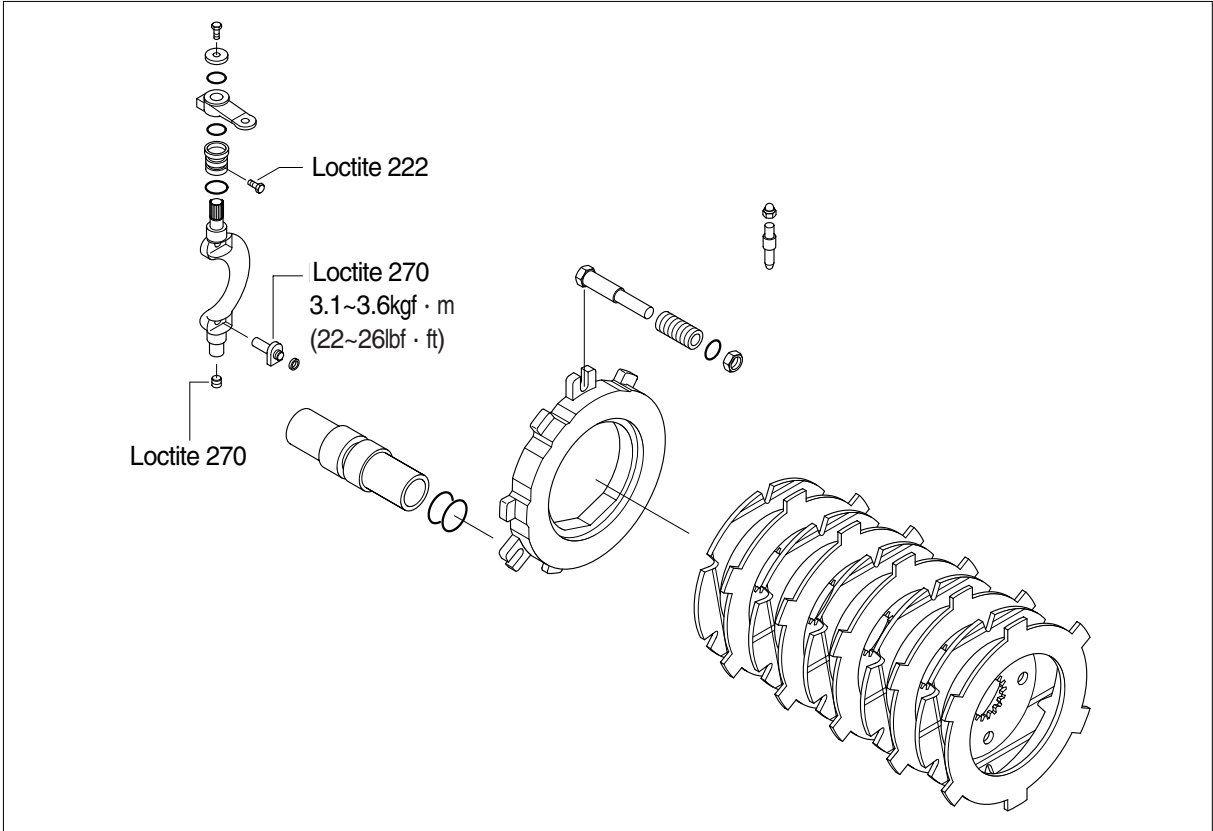

2) SAFETY BRAKE

- (1) Introduce in the hydraulic circuit 25~35 bar pressure, then remove the axle housing.



- (2) Loose the 4 assembling stud bolts and disassemble the intermediate covers.

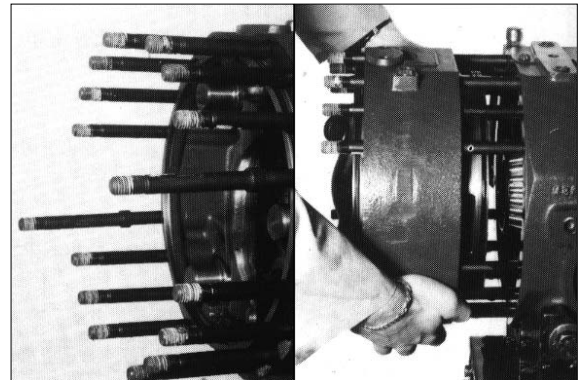

- (3) Disassembling of spring applied safety brake pistons. Reassemble the components in opposite sense.

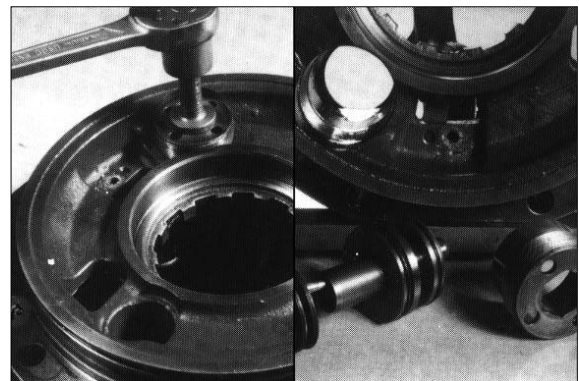

- (4) Check quote of cover.

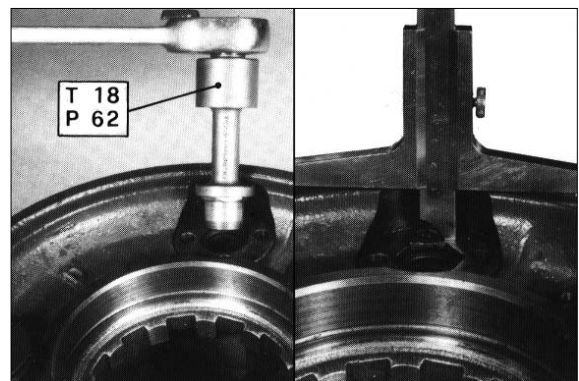

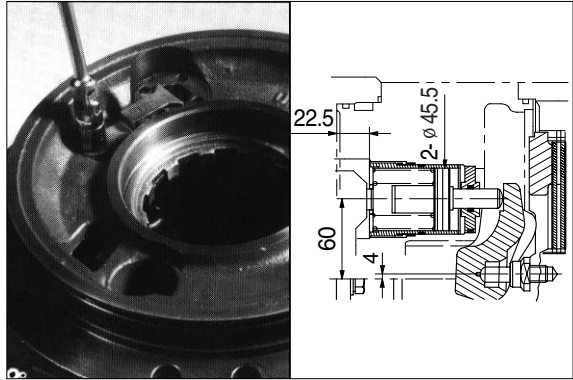

(5) Remove brake discs.

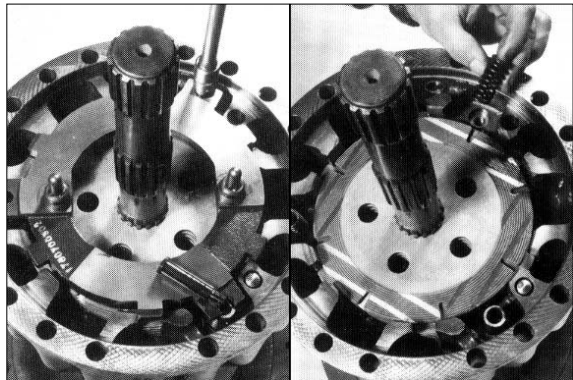

(6) For assembling align lubrication holes of brake discs.

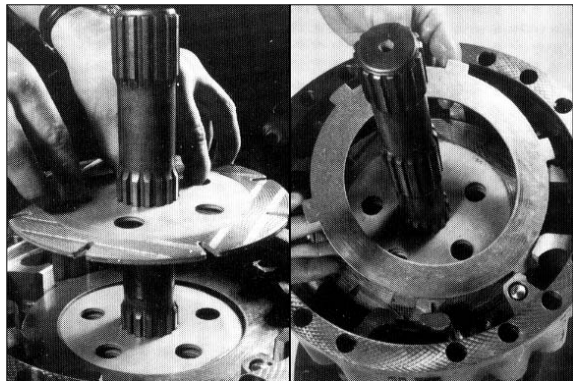

(7) Remove pinion and ring gear.

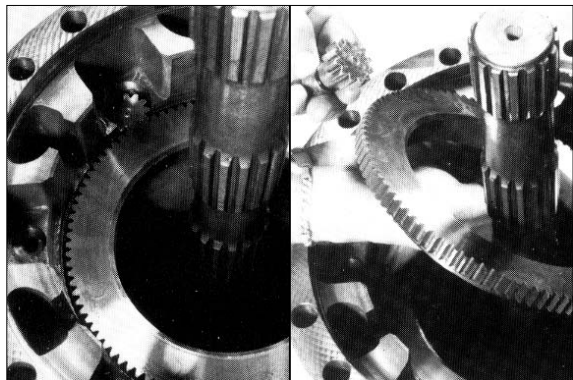

(8) Assemble of internal leverism.

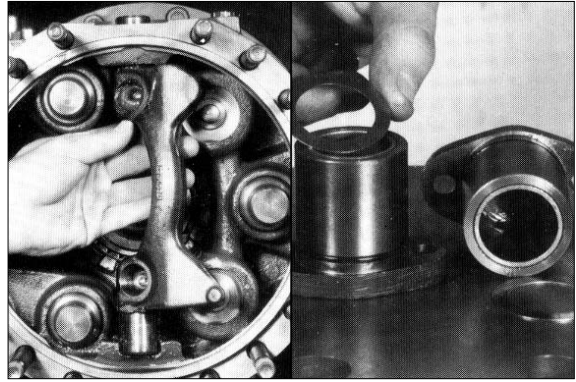

(9) Introduce in the hydraulic circuit 25~35 bar pressure and assemble the axen.

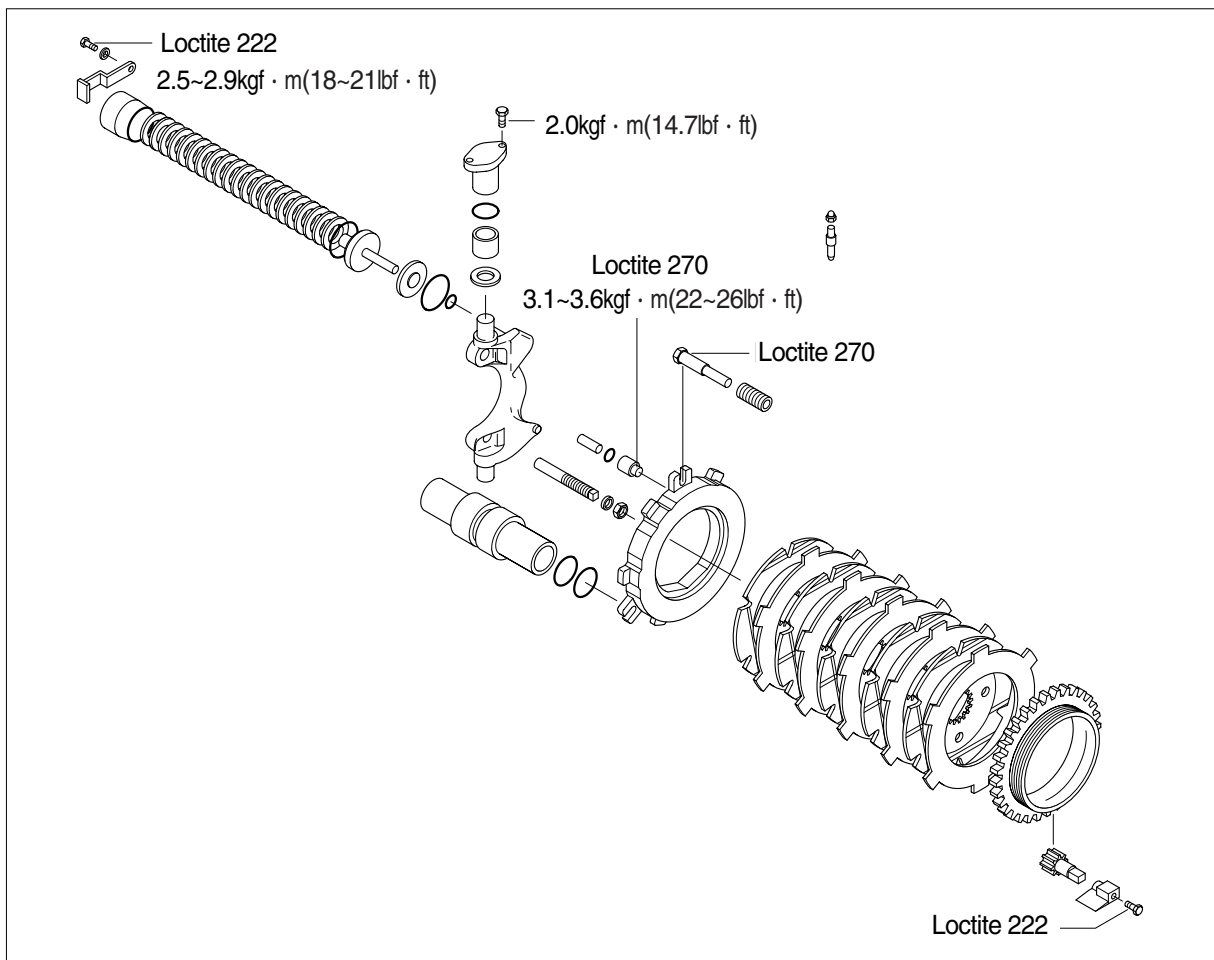
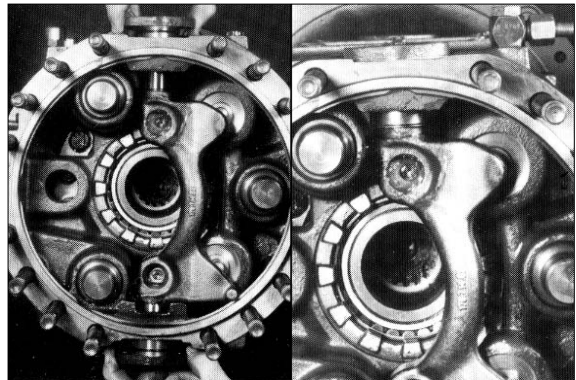

ADJUSTMENT

- (1) Introduce pressure in the hydraulic circuit with 25~35 bar.
Remove bolt and locking plate.

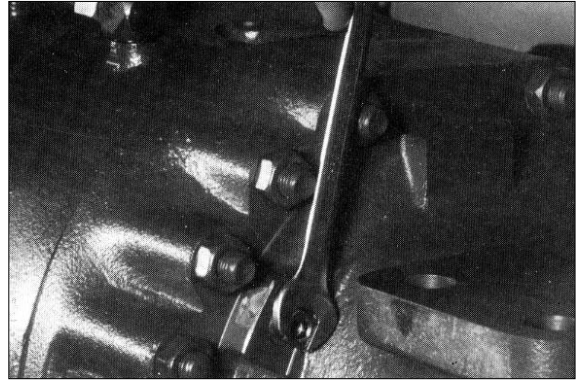

- (2) Turn the pinion with 0.82kgf · m(5.9lbf · ft) torque counterclockwise till it stops. Adjust the gap between the brake discs by turning 3 complete revolutions clockwise.

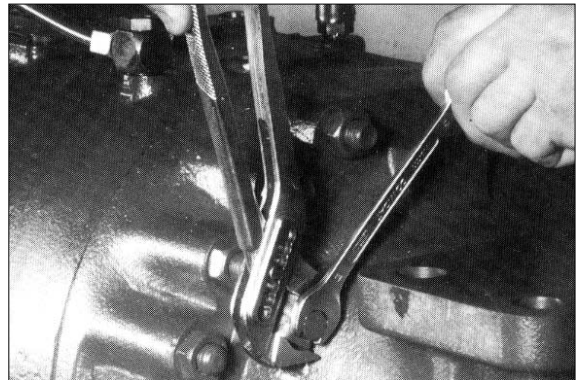

- (3) Adjust the bolts to unlock the safety brake at 47mm and lock the counter nut.

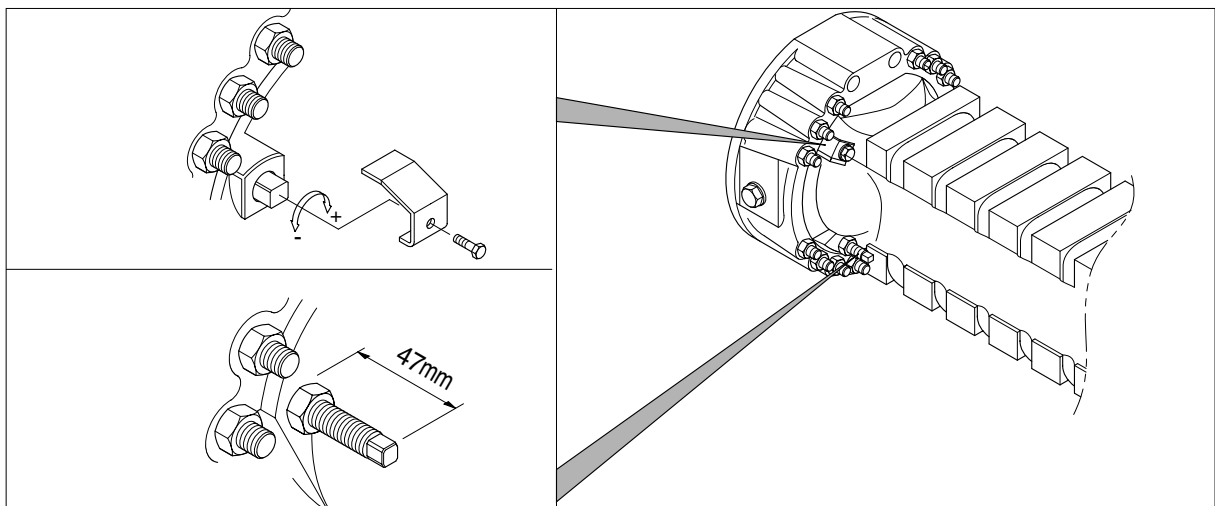
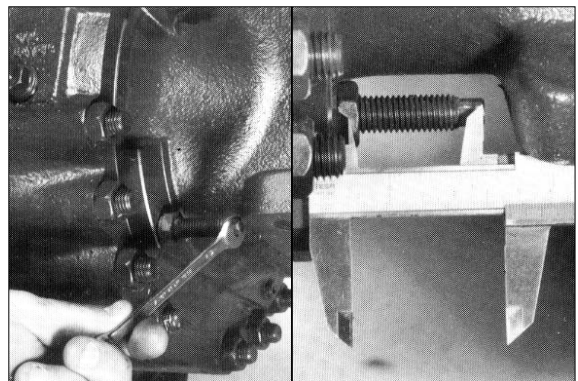

DISASSEMBLY

- (1) Actuate the hydraulic circuit with 5 bar.
See following page.

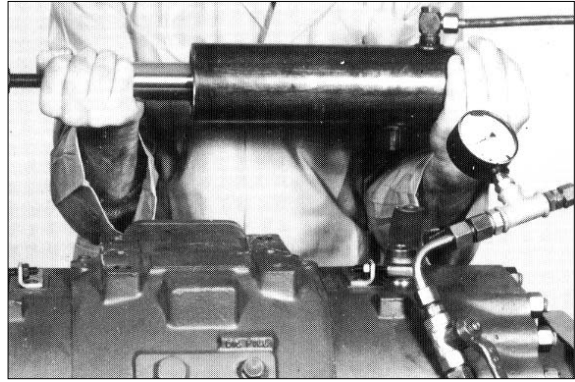

ADJUSTMENT

- (1) See brake disk play adjustment on page 3-146. Near the adjuster screw to the level until the idle stroke has been eliminated (Internal spring action).

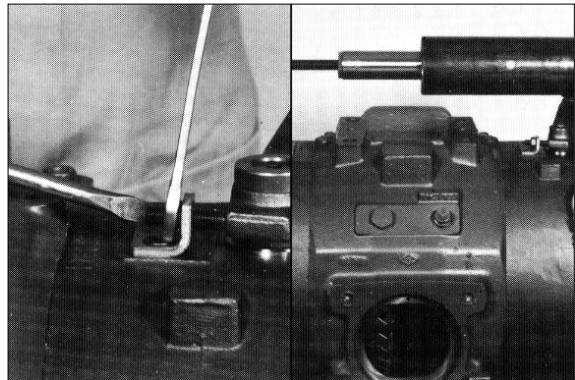

- (2) Mount the brake cylinder after pressurizing and adjust the screw so that the two levers rest on the end of travel screws. Now tighten the lock nut using loctite 242.

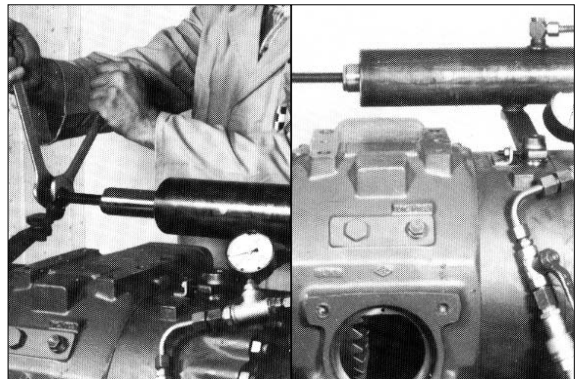

- (3) Pressure according to the type of cylinder and spring load curve.

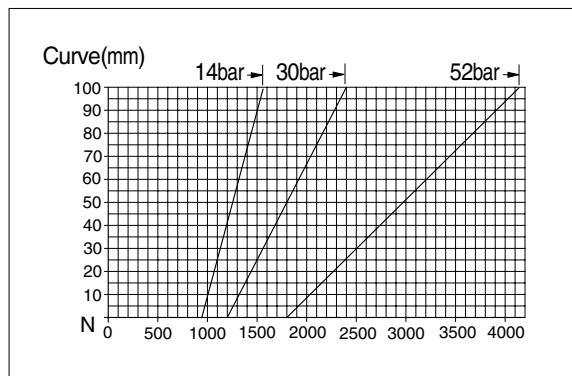

PARKING BRAKE ADJUSTMENT OF CAT 3 AXLES WITH ADJUSTABLE MECHANICAL STOPS.

1. Free both transmission levers from the control wire and from further connections.
2. Apply an 0.8~1.0kgf load to the levers so that the lever rests on the thruster disk without deforming the lever mechanisms.
3. Once in this position, set the adjuster screws of the stops in contact with the levers without deforming the lever mechanisms.
4. Reconnect the control wires to the levers once this position has been obtained.
5. Check that both transmission levers rest against the stop screws during the brake disengagement phase.

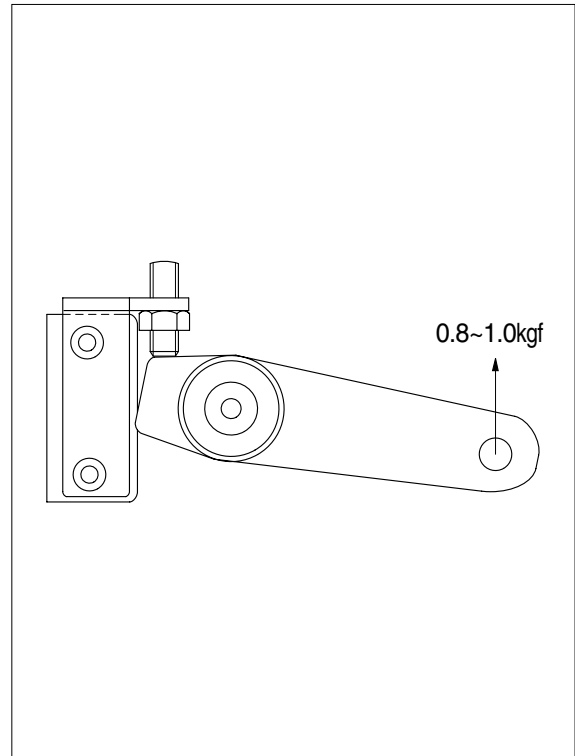

3) WHEEL HUB DISASSEMBLING AND ASSEMBLING

(1) Disassembling of wheel hub.

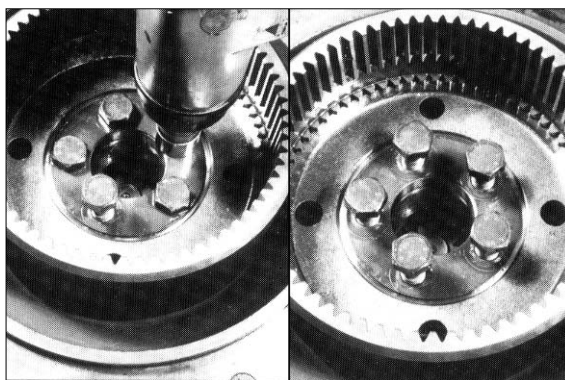
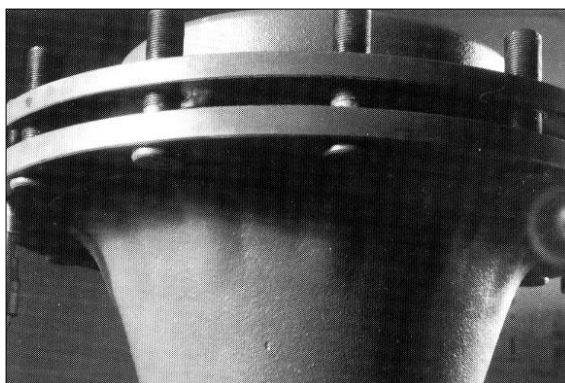

(2) Disassembling the crown wheel

- ① Use partially threaded M18×1.5 screws to support the puller.

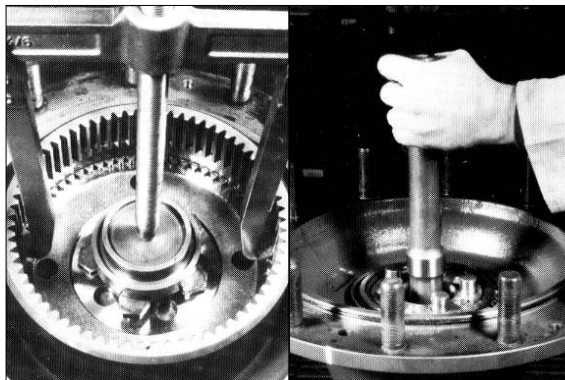

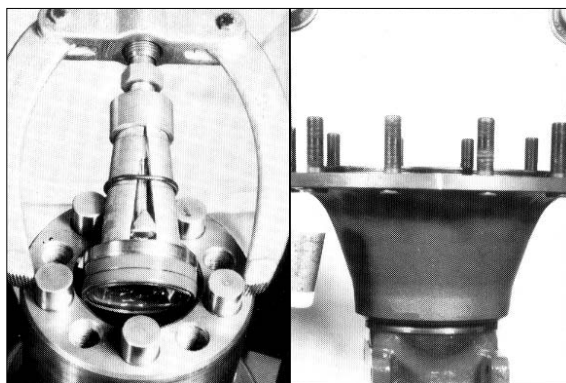

- ② Assembling of wheel hub
- a. Installation of outer races of taper roller bearings.
 - b. Assembling of bearing.

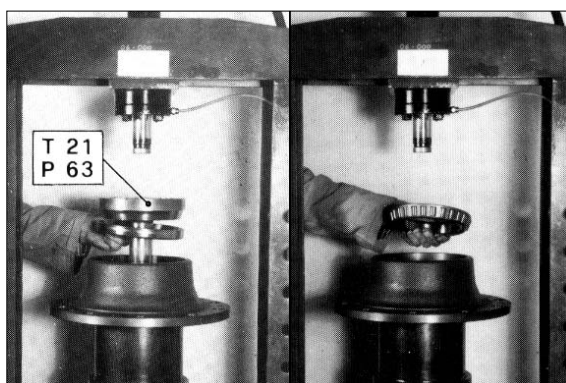

- c. Fitting of seal.
- d. Fitting of wheel studs.

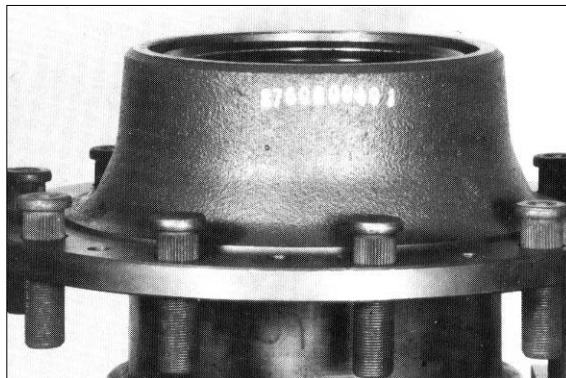
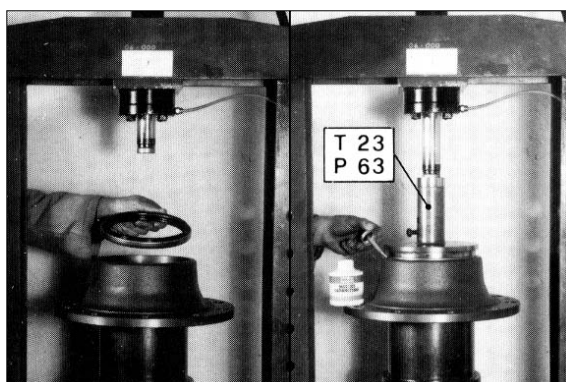

- ③ Assembling of wheel hub, seal and center rings.

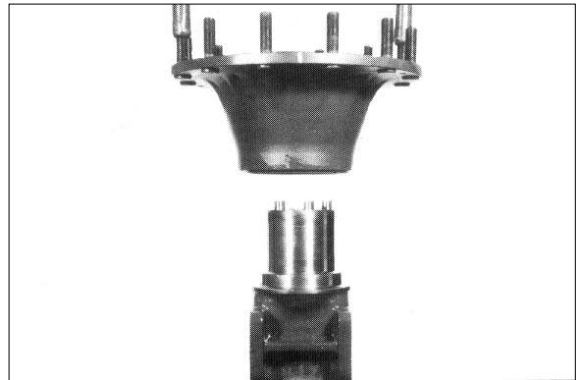
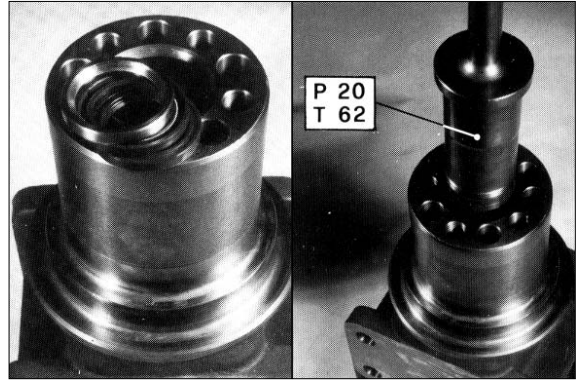

4) WHEEL HUB ONTO AXLE HOUSING

(1) Fitting the gear rim on the wheel center.

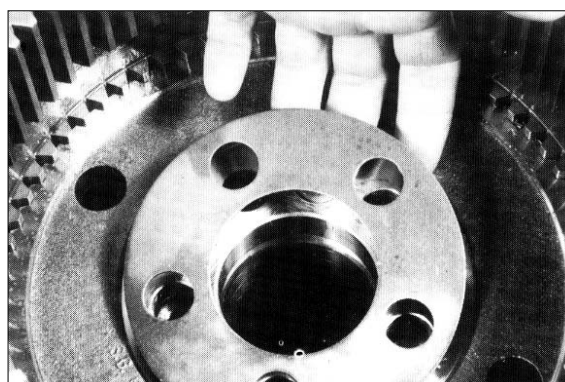
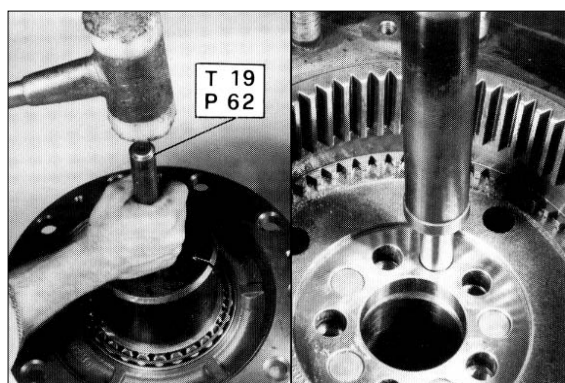
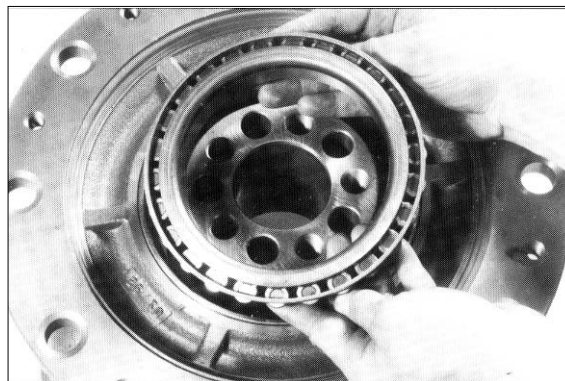

(2) M18×1.5, 10K screws. Mount with loctite 270.

Clamping torque 46.9~47.4kgf · m
(339~343lb · ft).

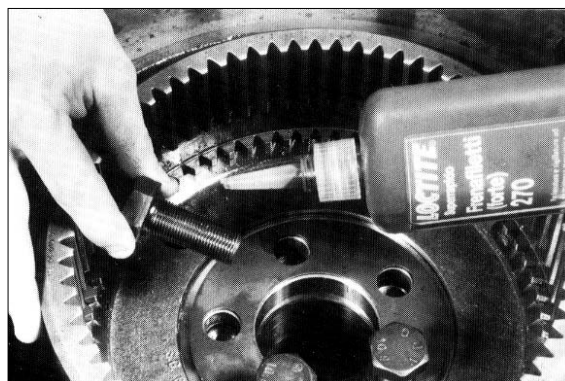

(3) Torque of new bearings with seal : From
3.1~4.1kgf · m(22~30lbf · ft).

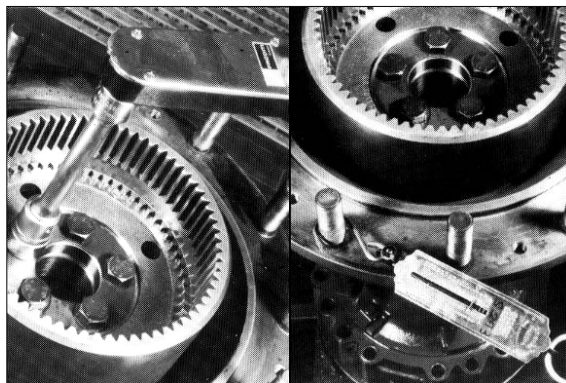

5) WHEEL CENTER VERSION WITH 10 PILOT BOLTS

- (1) Demounting the wheel center version with 10 pilot bolts.

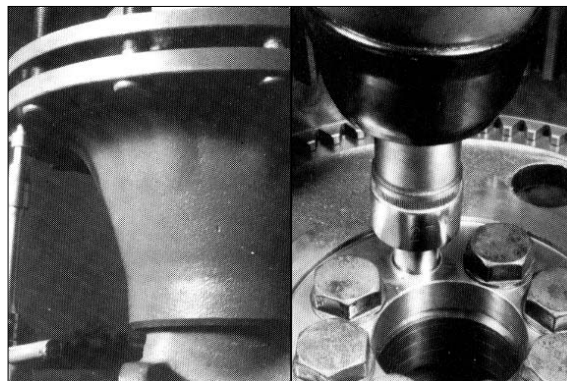

- (2) Clamping torque for bolts $M18 \times 1.5$, 10K
 $46.9 \sim 47.4 \text{ kgf} \cdot \text{m}$ ($339 \sim 343 \text{ lbf} \cdot \text{ft}$).
Torque of new bearings with seal : From
 $3.1 \sim 4.1 \text{ kgf} \cdot \text{m}$ ($22 \sim 30 \text{ lbf} \cdot \text{ft}$).

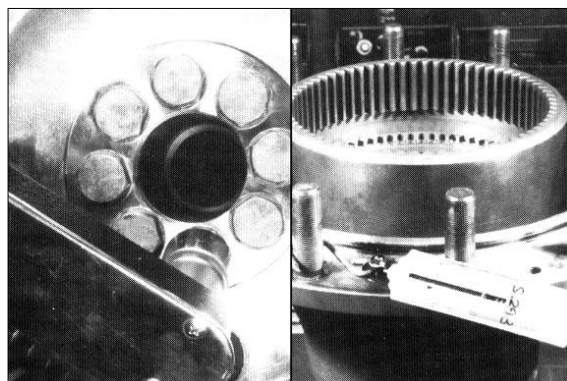

6) PLANETARY REDUCTION 6.23
(1) Disassembly

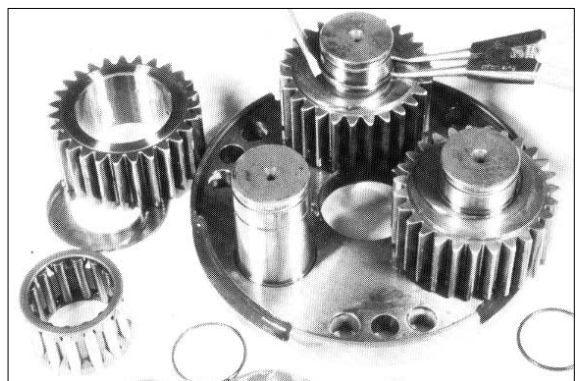
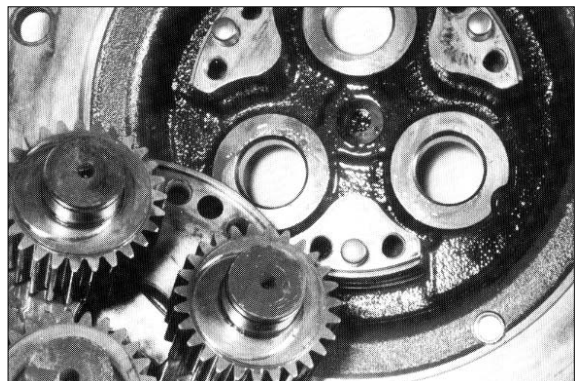
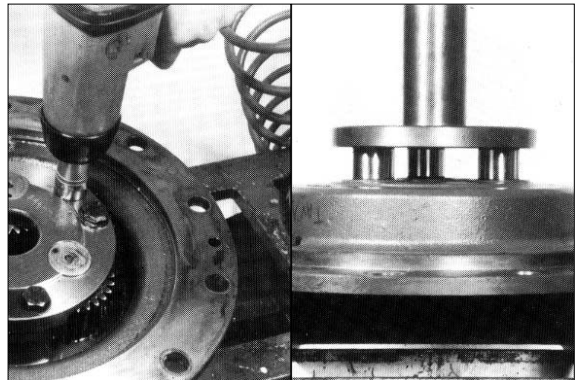
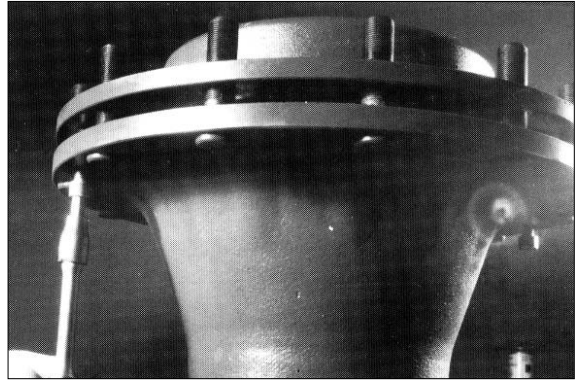

(2) Reassembly

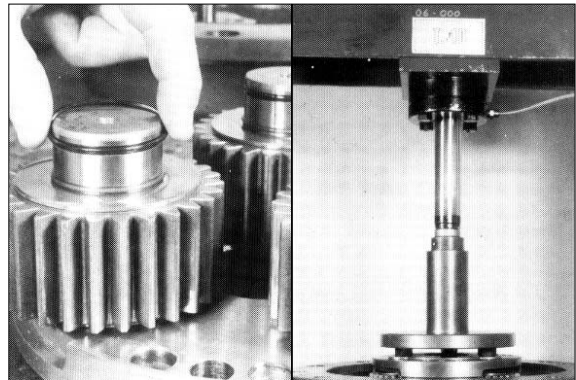
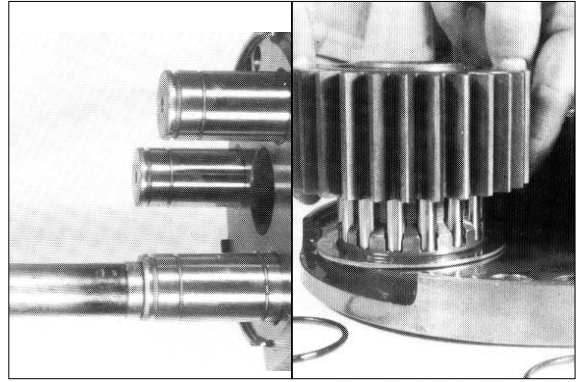

(3) Check the reference numbers.
Torque the screws at $32.1\sim 32.6\text{kgf}\cdot\text{m}$
($232\sim 236\text{lb}\cdot\text{ft}$).

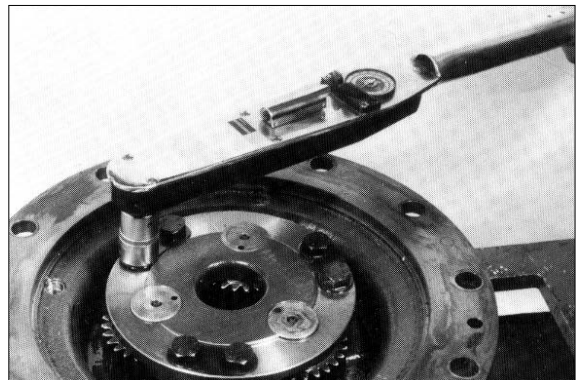
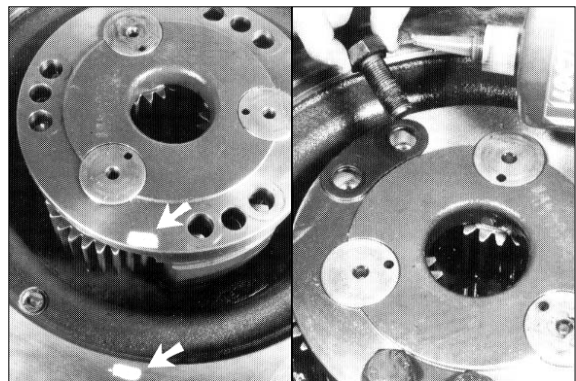

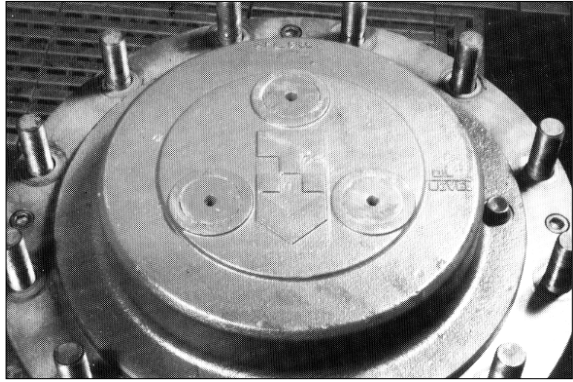

7) FINAL DRIVE 244-143

DEMOUNTING

(1) Use partially tightened screws as pullers.

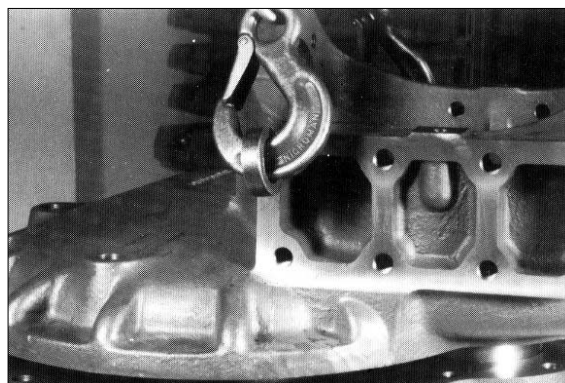

(2) Lock the ring nut then remove the hub gear.

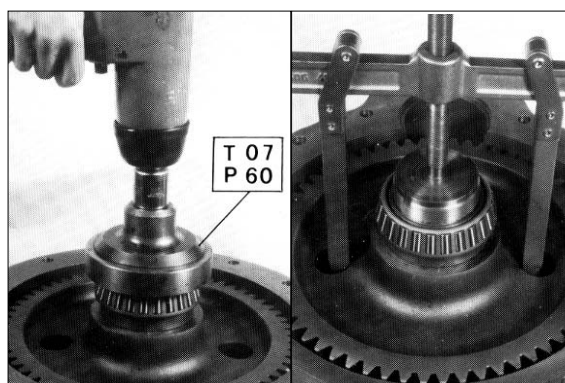

(3) Disassembly the hub cover.
Replace the retaining ring.

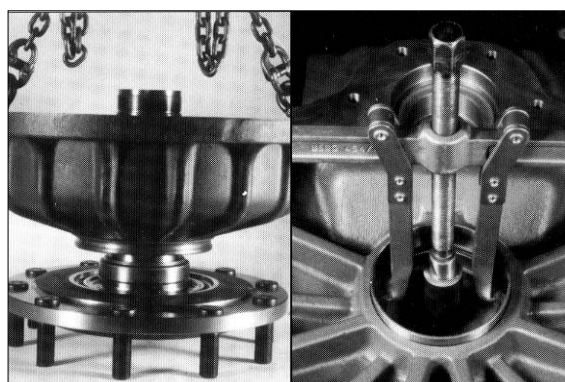

ASSEMBLY

(1) Assembling the stud bolts.

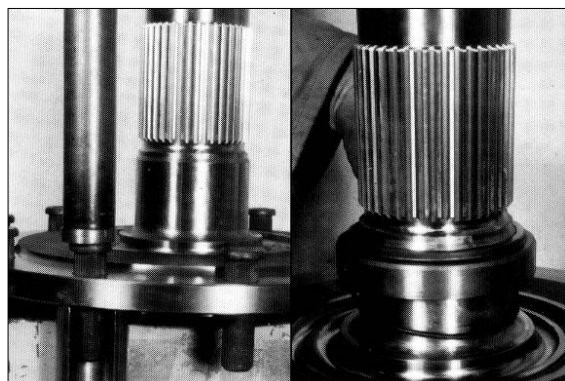

(2) Dust excluder and oil ring.

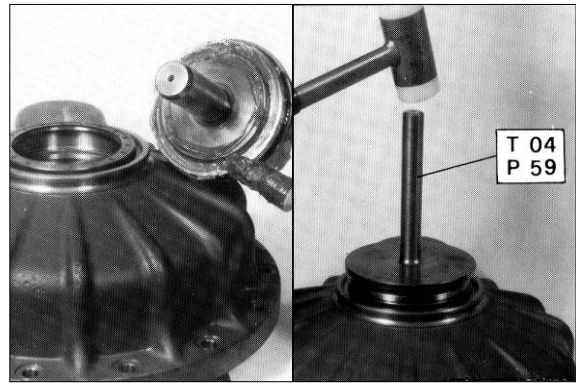

(3) Mounting the bearings.

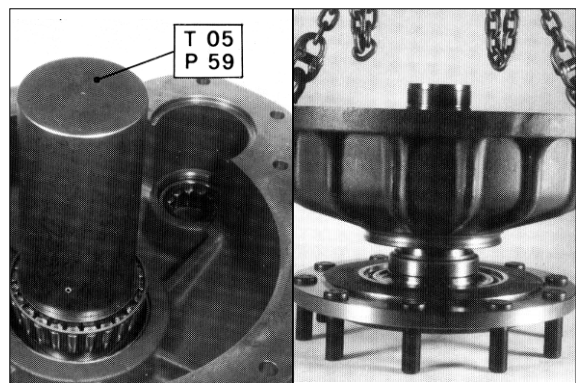
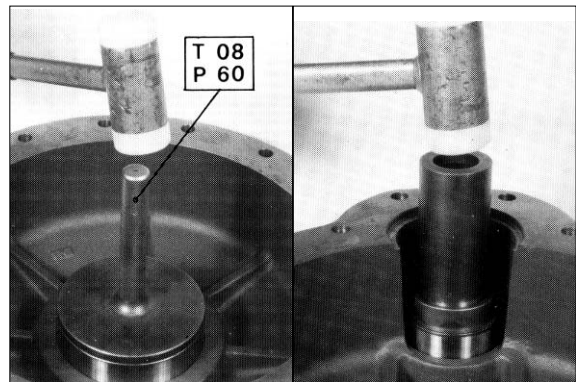

(4) Heat the gear to 140°C for assembly.

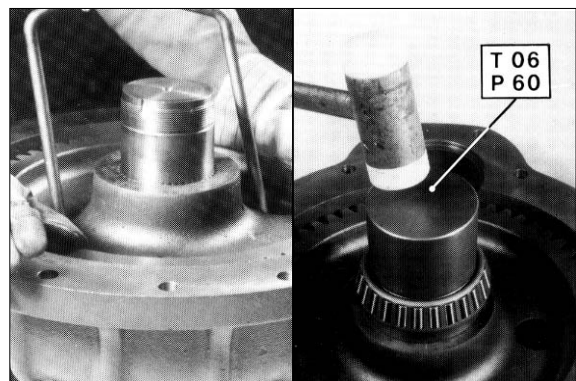

- (5) Tighten the ring nut at 81.6~91.8kgf · m
(590~664lb · ft) using loctite 270.



- (6) Chamfer the ring nut.

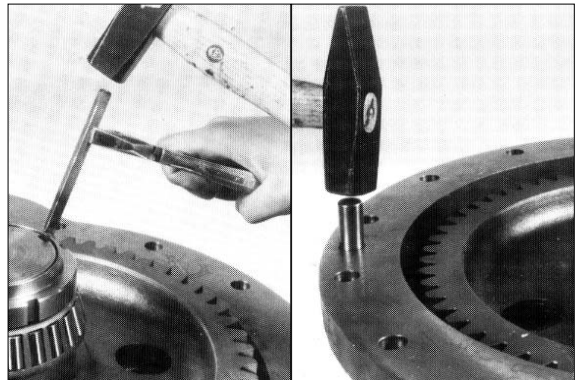

- (7) Pinion assembly.

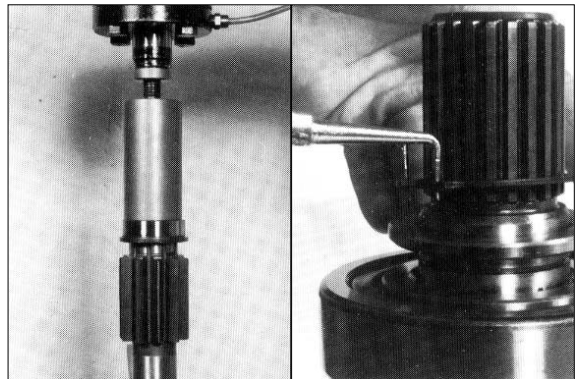

- (8) Assembly with loctite 275 on the surfaces.
Take great care to clean the surfaces.

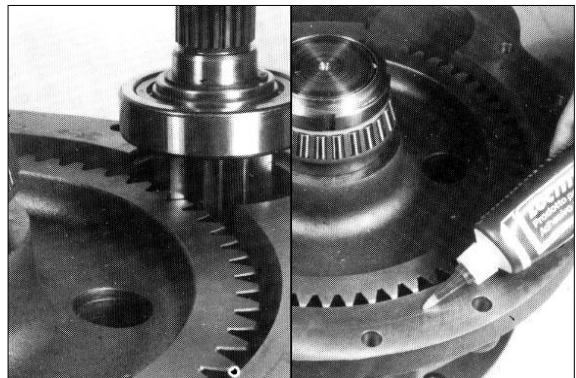

ASSEMBLY AND ADJUSTMENT

- (1) Preassembly with the same shims as those removed during disassembly, or with 1.00mm shims.

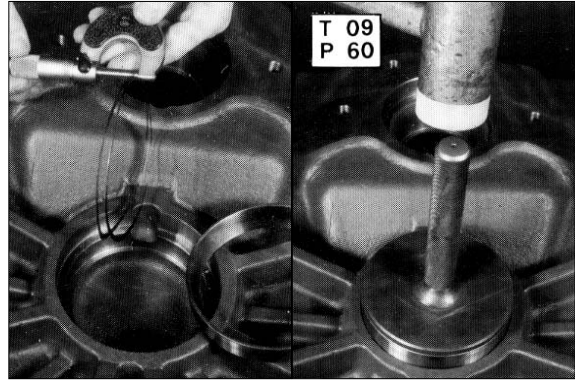

- (2) Axle shaft oil seal assembly.

- ① Check the rotation torque applied tangentially to the wheel studs, which must be max 14.3~20.4kgf(With ring). To correct, add or remove shims considering that a 0.05mm variation cause a variation of ~2.0kgf.

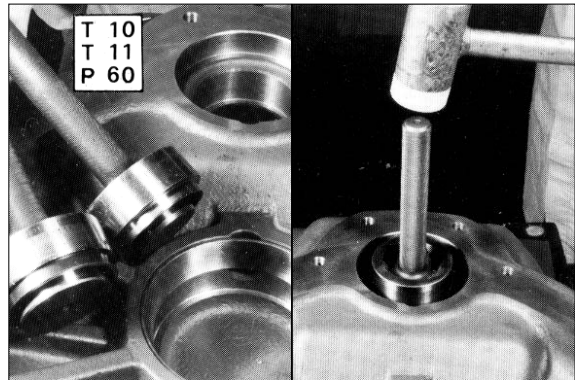

- ② Assembly using loctite 275. Tighten the screws with a torque wrench 23.4~23.8kgf · m(170~172lbf · ft).

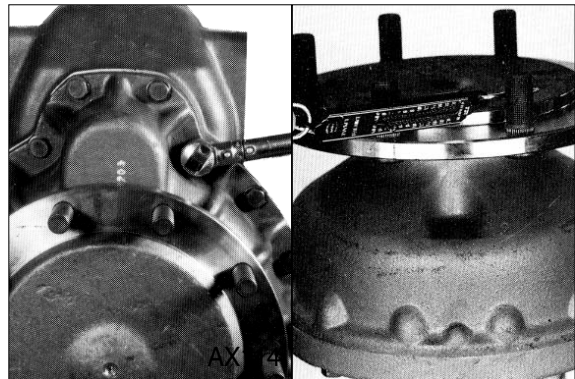

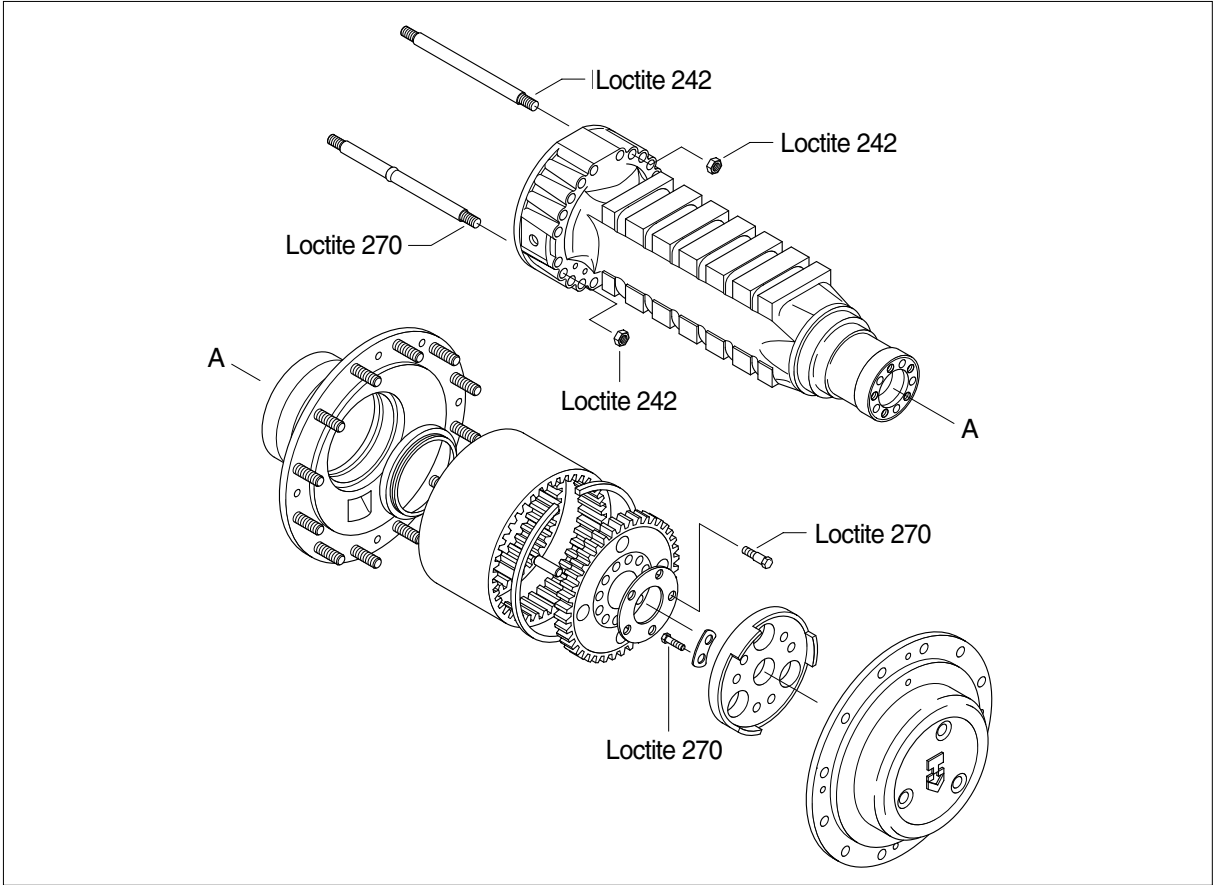

8) REAR AXLE BEVEL PINION SUPPORT

(1) Removal of bevel pinion support.

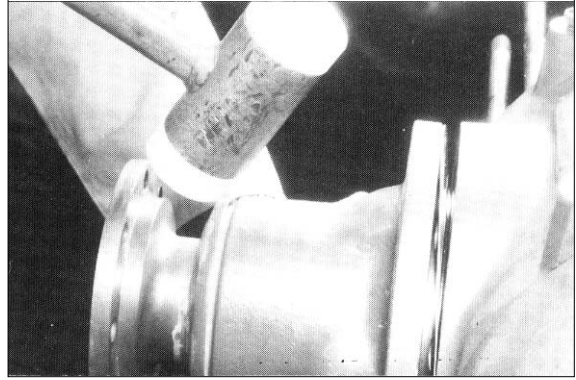

(2) Flange input.

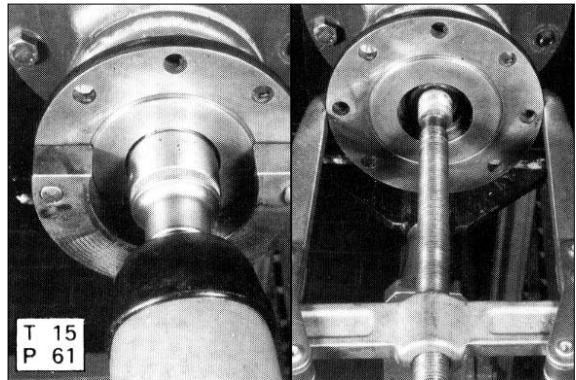

(3) Flanged to the reduction gear.

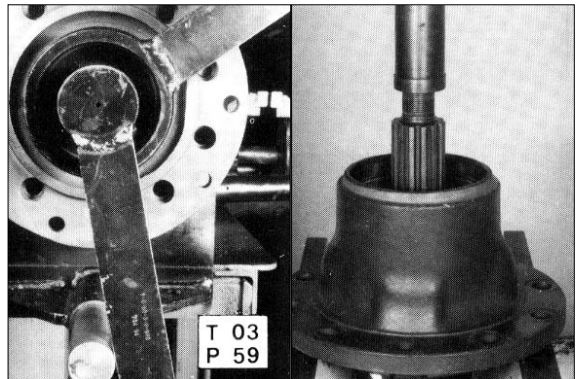

(4) Demounting the bearing plus thrust plates.

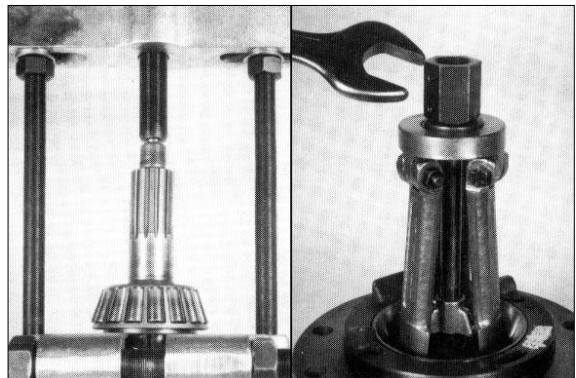

- (5) Assemble the external races.
Taper roller bearings.
Check cover measurement A.

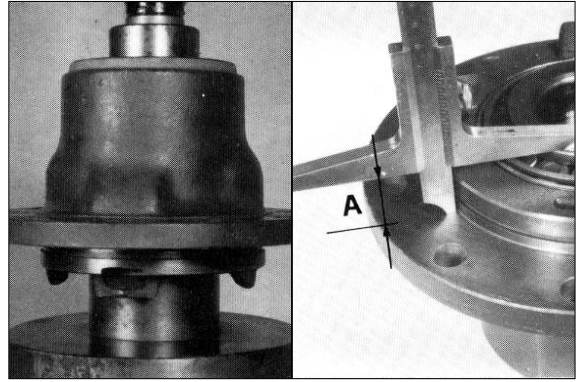

- (6) Determination of shim pack S1 for the preload of the taper roller bearings $S1 = B - C + X$.
 X = Value to add in order to obtain the correct preload of the taper roller bearings.

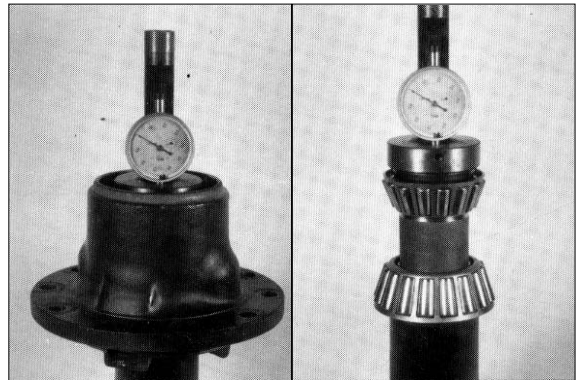

- T26/P65 Flange input.

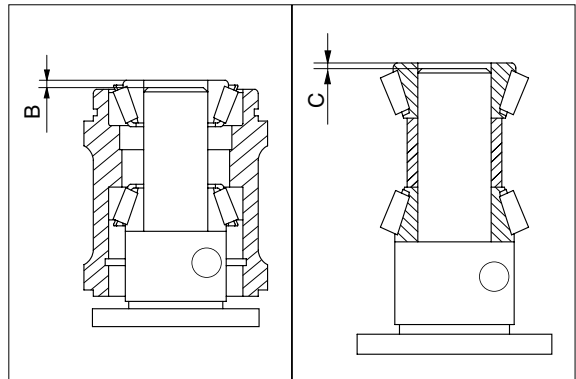

Value X = See figure.

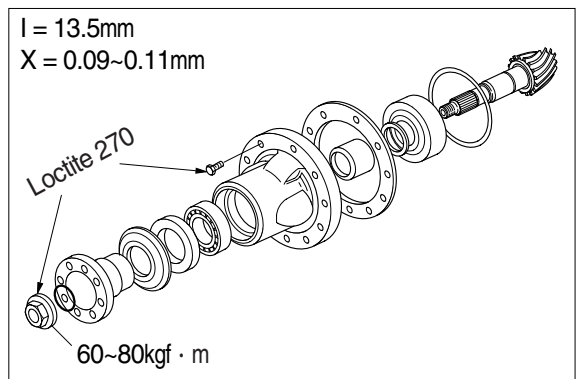

(7) Assembly of bevel pinion support and seal.

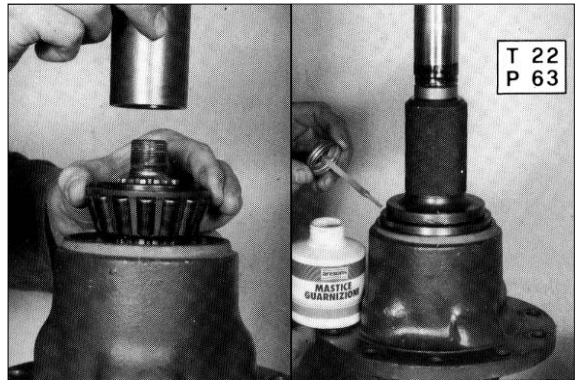
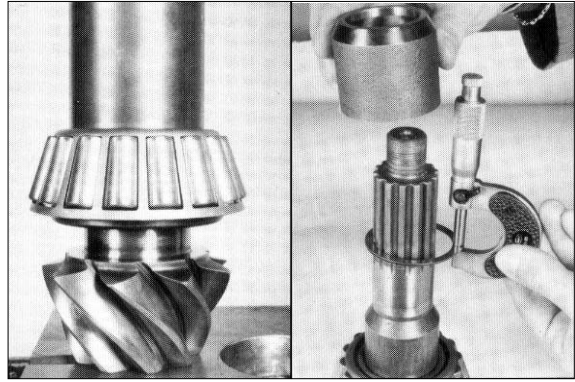

(8) Fitting the dust guard on the flange.

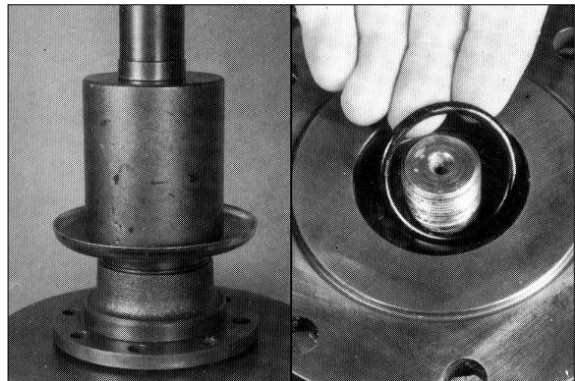

(9) Assembly with loctite 242.

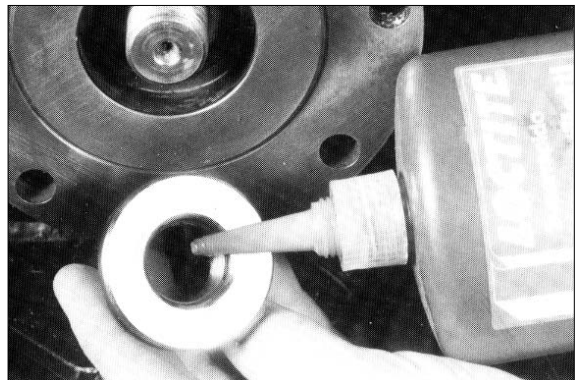

FLANGE INPUT VERSION

(1) Tighten the nut with a torque wrench.

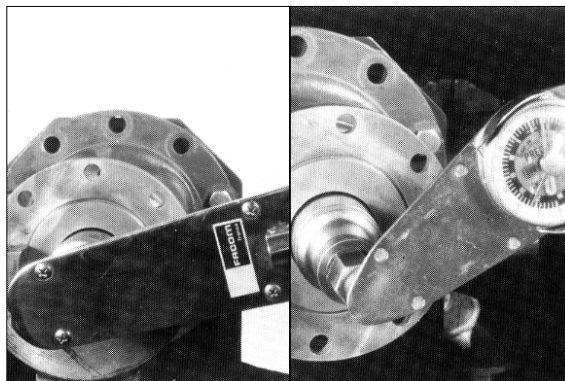

(2) Check rotation torque : See figure

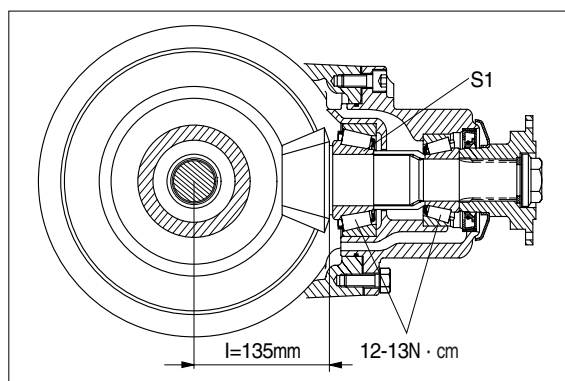

9) FRONT AXLE PINION SUPPORT

- (1) Demounting the pinions and bearing plates.

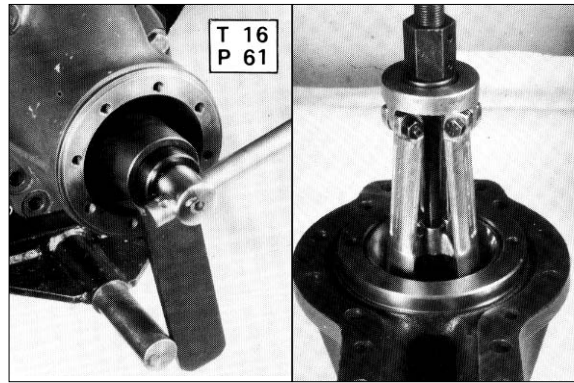

- (2) How to establish shims S2 to position the bevel pinion. Insert the dummy bearing and check the difference (Photo ④) after having zeroed the instrument on a surface plate with a 20mm shim (Photo ③). Measured difference corresponds to S2. Add or remove the differential shims when the center distances differ from 150mm (Dimension stamped on the pinion).

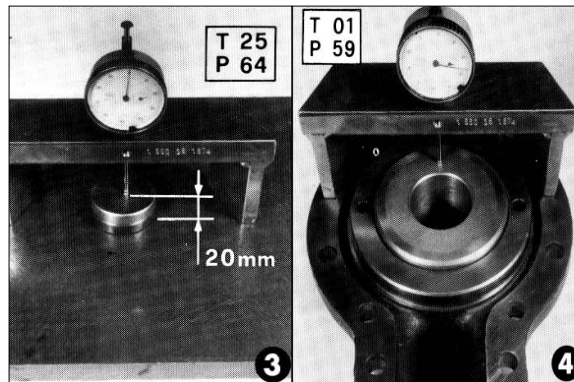

Example

Center distance : 149.8

Shims = $(150 - 149.8) + S2$

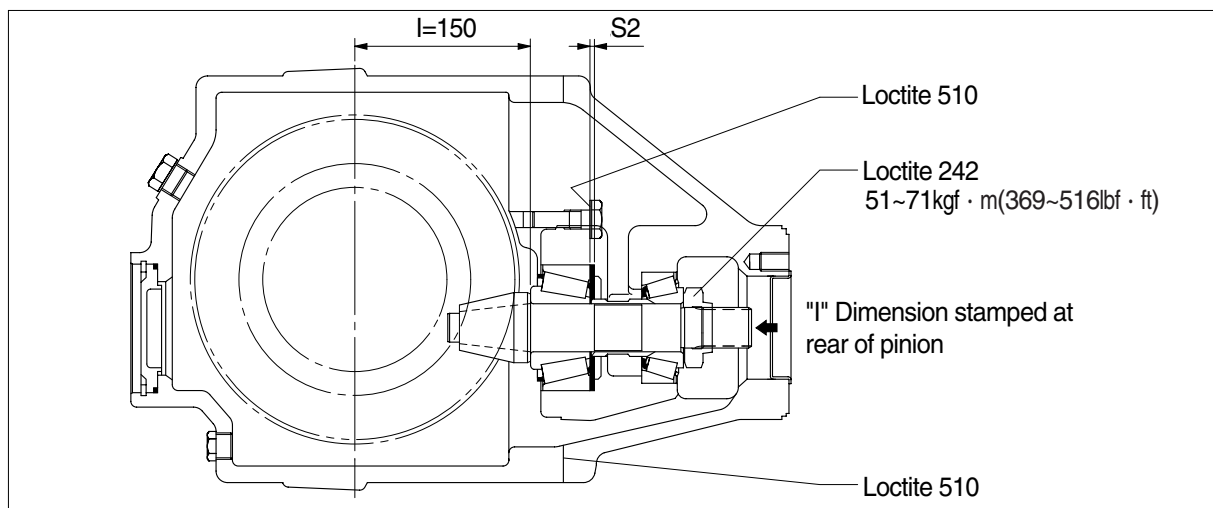

- (3) Establishing the pinion bearing preload shims. See page 3-118 and figure.

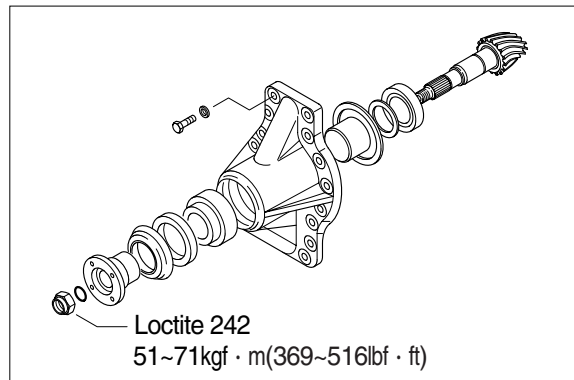
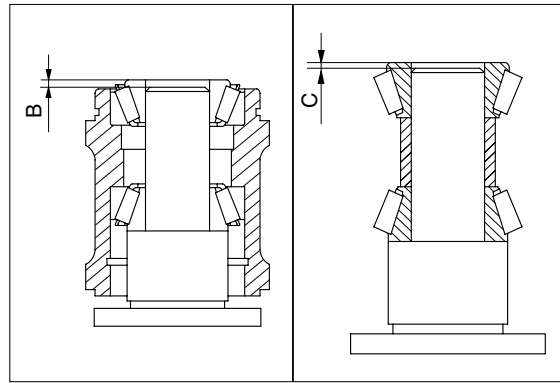

- (4) Check the measurement(Photo ①) after having mounted the shims and thrust plate. It must be 0.10mm~0.15mm less than zero. This difference is annulled by the effect of bearing interference in the definitive assembly.

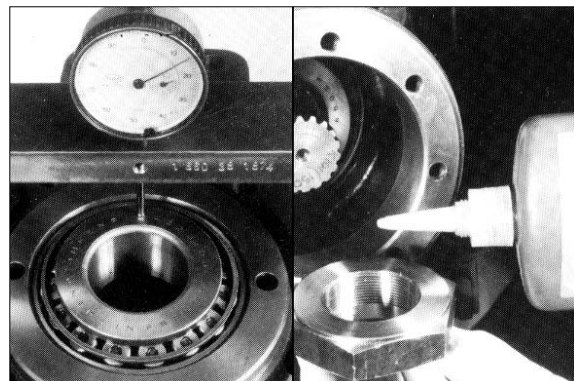

- (5) Chamfer.

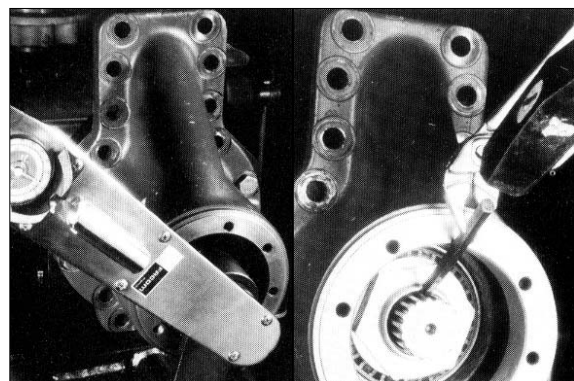

(6) Check the final center distance and stamp it on the cover.

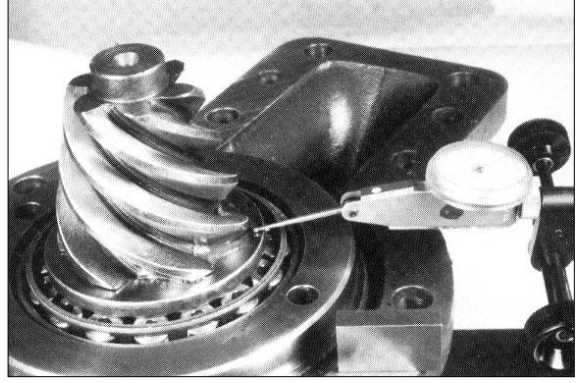

10) 276 -176 -143 AXLE ADJUSTMENT OF BEVEL GEAR SET

(1) Determination of shim pack S2 for adjustment of bevel pinion position : $S2 = (l + A) - (D + r)$.

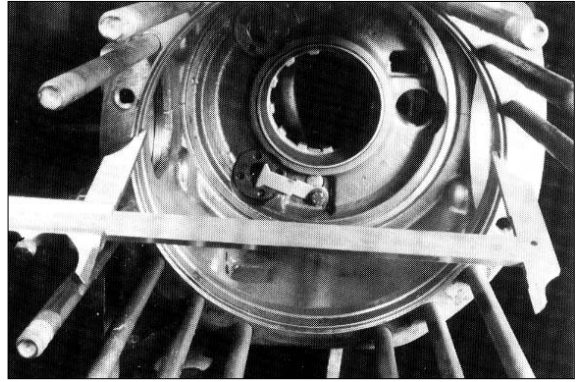

Photo ② = D, Photo ① = $\phi/2 = r$

Photo ③ = l (Dimension stamped on the pinion).

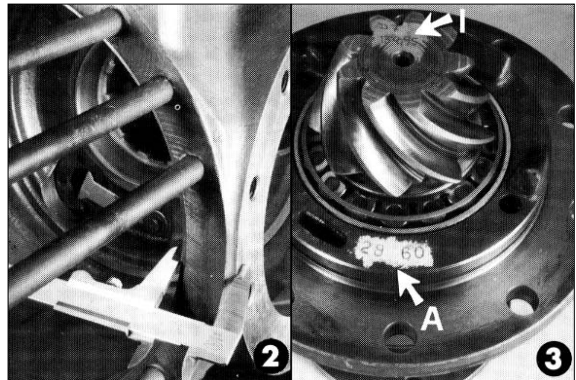
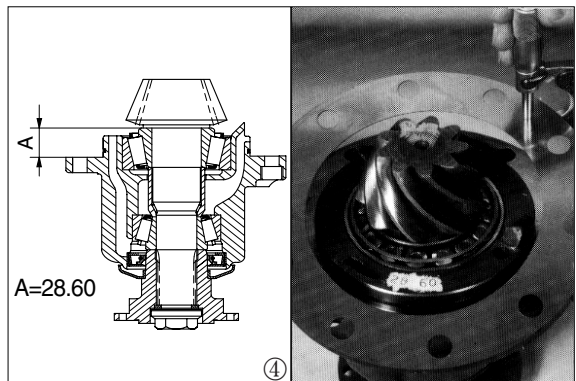
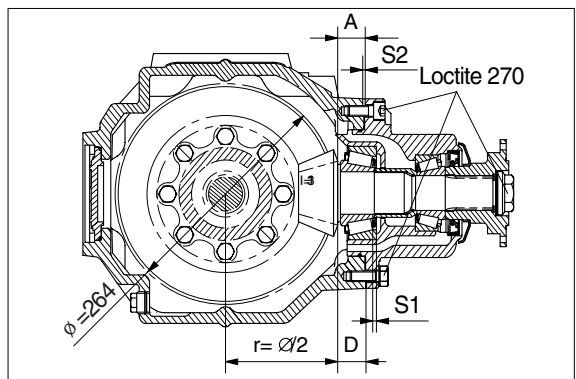

Photo ④ = A (Dimension stamped on the cover pinion).



(2) Assembly of bevel pinion support with shim pack S2.



(3) Assembling central axle housing.

- ※ Be careful not to damage the tight surfaces of the O-rings while inserting the differential case into the central axle housing.

Play : 0.18~0.25

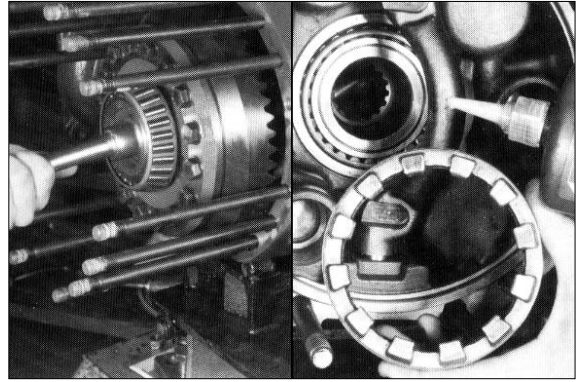

(4) Screw in the adjusting nuts to obtain approximate 0.20~0.27mm backlash between the teeth of the bevel gear set, without preloading the taper roller bearings. Check the rotating torque of pinion and differential. Tighten nut on opposite site to the crown wheel to obtain a 0.05~0.07kgf · m(0.37~0.52lbf · ft) higher rotating torque on the pinion.

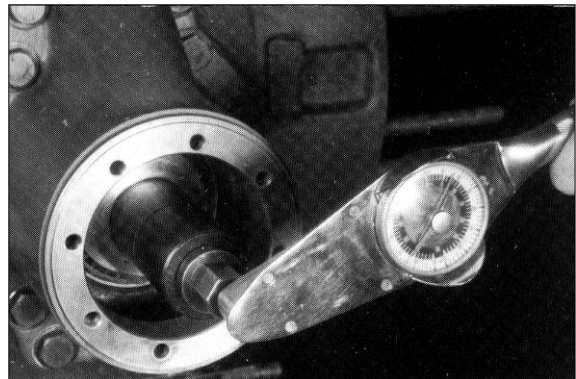
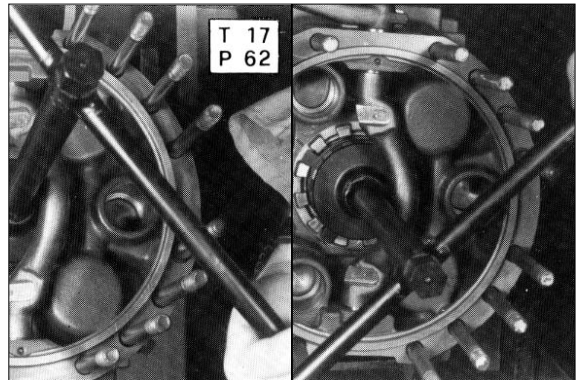

(5) Mark both ring nuts. To adjust the backlash move ring nuts only. Loosen the one on bevel crown wheel side and tighten the opposite one for the equal measure if the backlash is too low ; Viceversa if the backlash is too high.

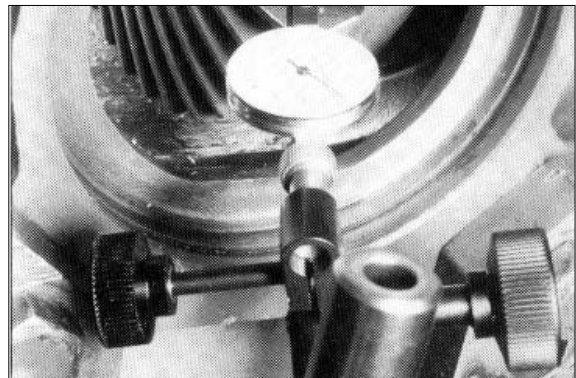

- (6) Mount locking tabs in the best position and punch in place.

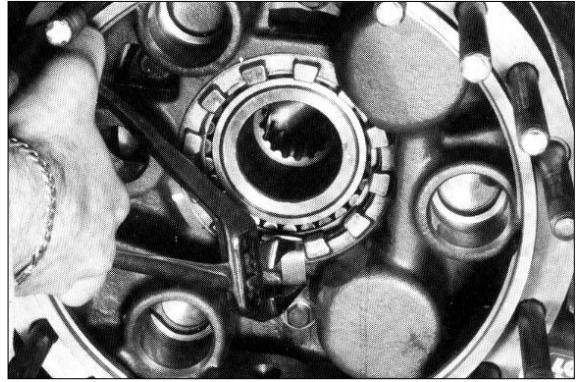

11) DIFFERENTIAL HOUSING

(1) Removal of the differential from the axle.

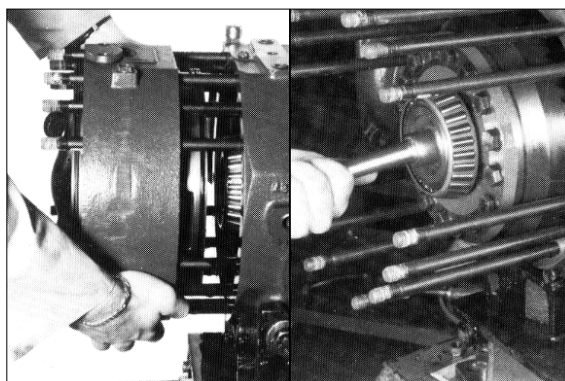
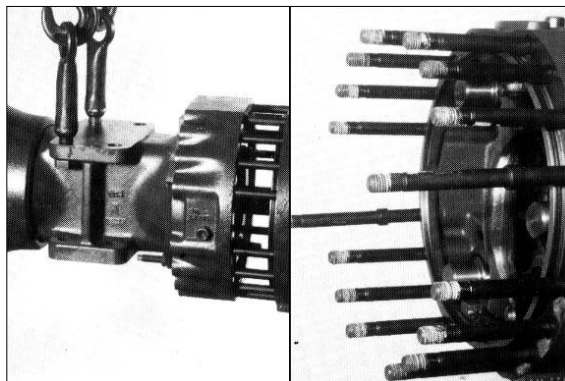

※ Replace the fitting bolts of the crown wheel every time that they have to be removed.

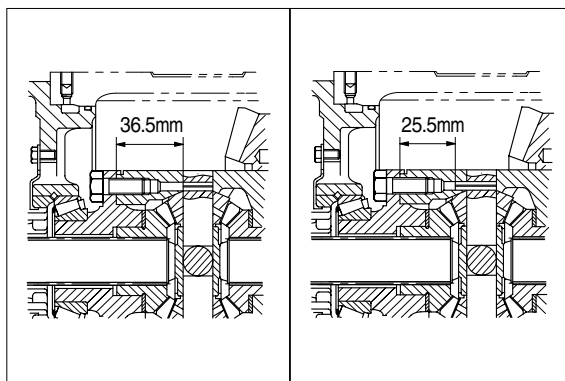
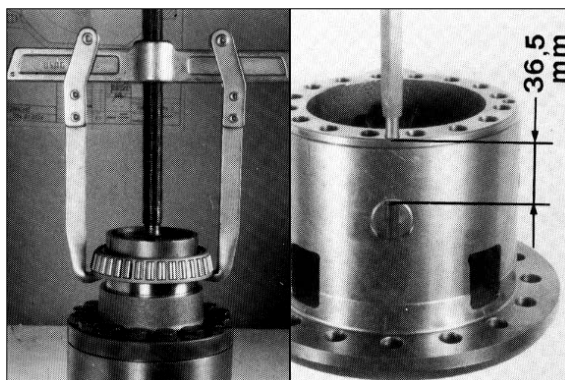

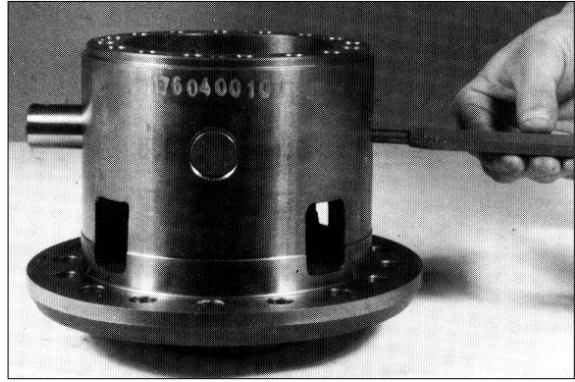

(2) Mounting sun wheels and planet gears.

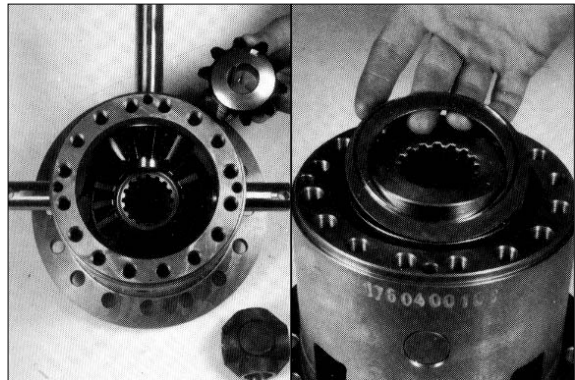

(3) Insert the spring pins half way up the pin.

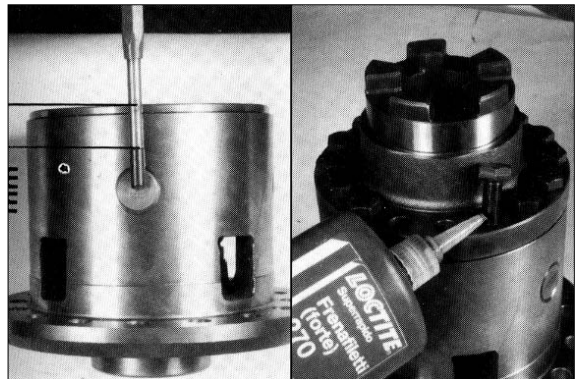

(4) Torque all bolts M12×35×1.25-10K and M12×30×1.25-10K with a torque wrench bolts clamping torque 13.8~14.1kgf·m(100~102lbf·ft). Use loctite 270.

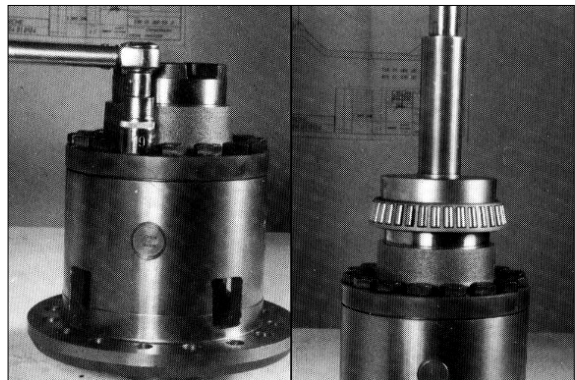

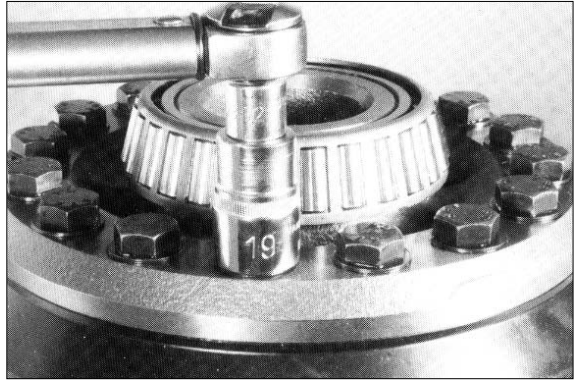

REAR

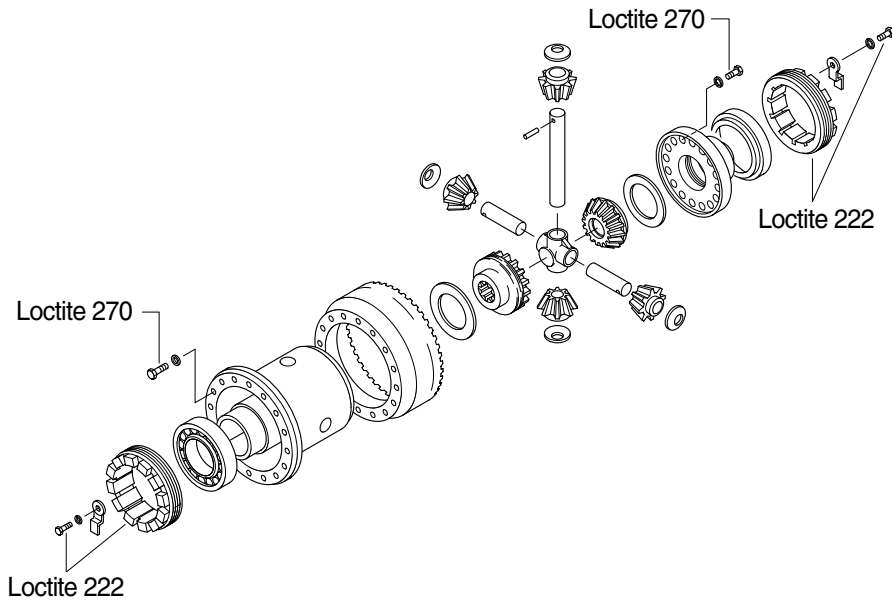

FRONT

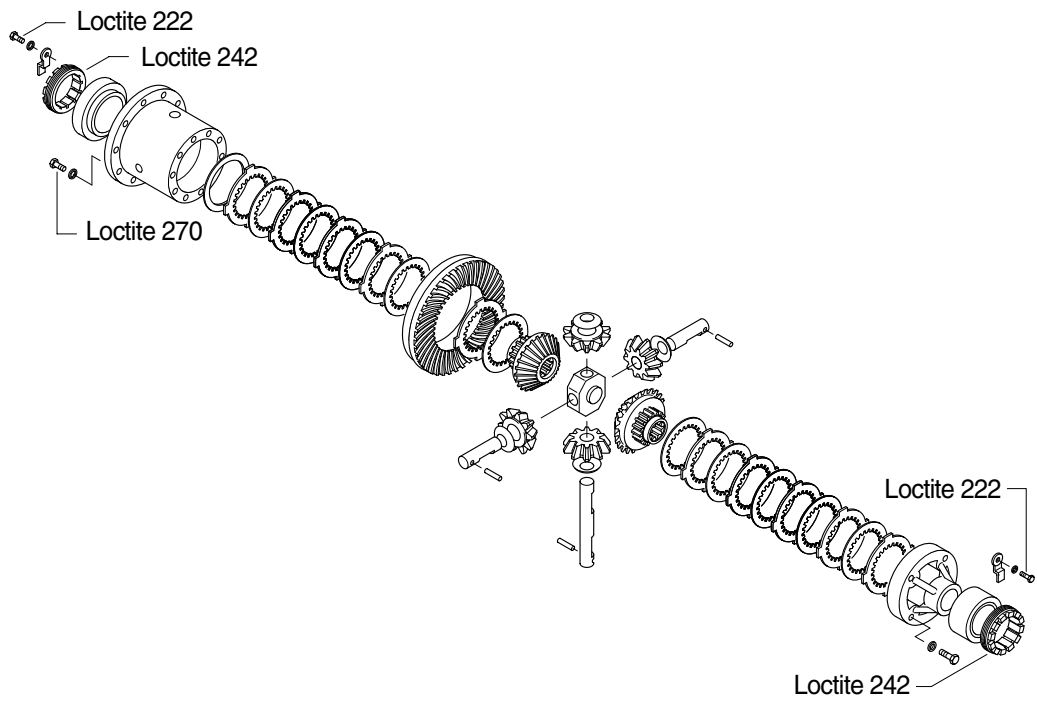

12) CENTRAL PART OF FRONT AXLE DISASSEMBLY

- (1) Demount the intermediate cover on the opposite side to the gear rim and insert tool.

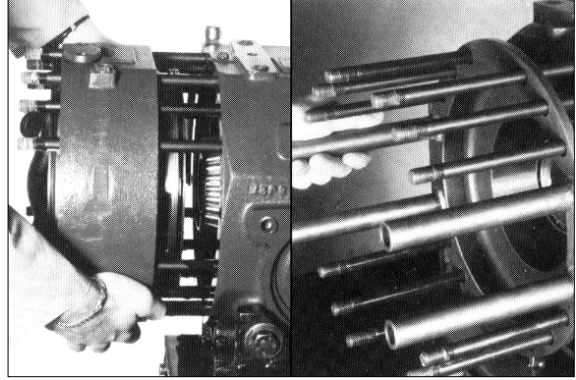

- (2) Slacken the screws. Insert tool and pull out the differential housing. Remove the gear rim from the pinion bearing side.

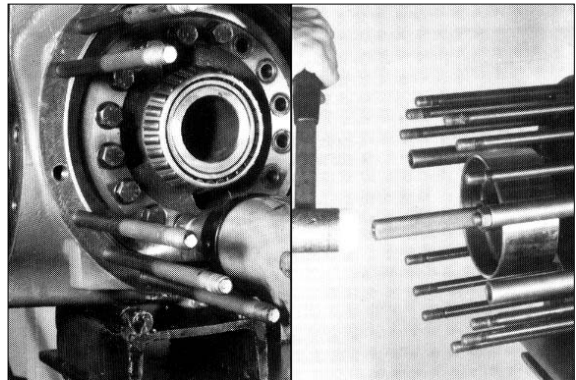

T24
P64

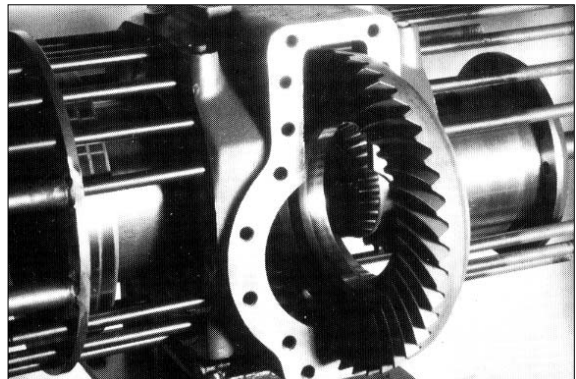

ASSEMBLY

- (1) Center the gear rim on tool.

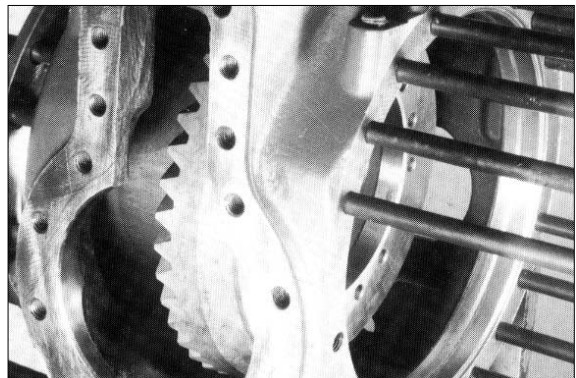

- (2) Insert the differential housing with tool and torque the screws.



- (3) Take care to prevent damage to the brake retention zones when assembling the parts.

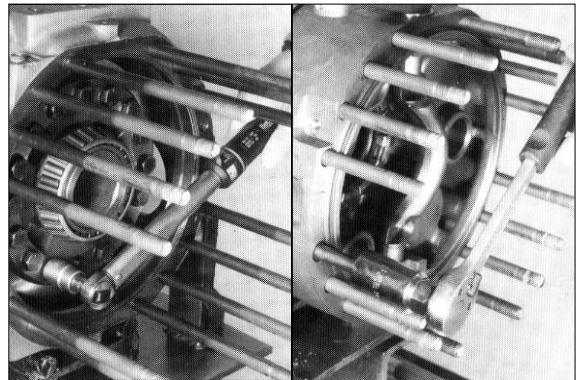

- (4) Mount the intermediate cover on the gear rim side using tools. Fit on the other intermediate cover.

