

CONTENTS

Foreword	0-1	5. TRANSPORTATION	
Before servicing this machine	0-2	1. Road traveling	5-1
Table to enter S/No and distribution	0-3	2. Preparation for transportation	5-2
EC regulation approved	0-4	3. Loading the machine	5-3
Safety labels	0-5	4. Fixing the machine	5-4
Machine data plate	0-12	5. Loading and unloading by crane	5-6
Guide(Direction, S/No, Symbol)	0-13	6. Towing the machine	5-7
1. SAFETY HINTS		6. MAINTENANCE	
1. Before operating the machine	1-1	1. Instructions	6-1
2. During operating the machine	1-5	2. Tightening torque	6-5
3. During maintenance	1-14	3. Specification of fuel, coolant and lubricants	6-8
4. Parking	1-18	4. Maintenance check list	6-10
2. SPECIFICATIONS		5. Maintenance chart	6-13
1. Major components	2-1	6. Service instruction	6-15
2. Specifications	2-2	7. Electrical system	6-42
3. Weight	2-6	8. Air conditioner and heater	6-45
4. Specification for major components	2-7	7. TROUBLESHOOTING GUIDE	
3. CONTROL DEVICES		1. Engine	7-1
1. Cab devices	3-1	2. Electrical system	7-2
2. Cluster	3-2	3. Power train system	7-3
3. Switches	3-14	4. Hydraulic system	7-4
4. Control device	3-27	8. INDEX	8-1
5. Air conditioner and heater	3-24		
6. Others	3-27		
4. OPERATION			
1. Suggestion for new machine	4-1		
2. Check before starting the engine	4-2		
3. Starting and stop the engine	4-3		
4. Warming-up operation	4-6		
5. Operation of the working device	4-7		
6. Traveling of the machine	4-8		
7. Efficient working method	4-13		
8. Adjustment of the work equipment	4-20		
9. Operation in the special work sites	4-22		
10. Storage	4-24		

FOREWORD

This manual contains a number of instructions and safety recommendations regarding driving, handling, lubrication, maintenance, inspection and adjustment of the wheel loader.

The manual is to promote safety maintenance and enhance machine performance.

Keep this manual handy and have all personnel read it periodically.

If you sell the machine, be sure to give this manual to the new owners.

This machine complies with EC directive "2006/42/EC".

1. **Read** and **understand** this manual before operating the machine.

This operator's manual may contain attachments and optional equipment that are not available in your area. Please consult your local Hyundai distributor for those items you require.

Improper operation and maintenance of this machine can be hazardous and could result in serious injury or death.

Some actions involved in operation and maintenance of the machine can cause a serious accident, if they are not done in a manner described in this manual.

The procedures and precautions given in this manual apply only to intended uses of the machine.

If you use your machine for any unintended uses that are not specifically prohibited, you must be sure that it is safe for you and others. In no event should you or others engage in prohibited uses of actions as described in this manual.

2. **Inspect** the jobsite and **follow** the safety recommendations in the **safety hints** section before operating the machine.

3. Use **genuine Hyundai spare parts** for the replacement of parts.

We expressly point out that Hyundai will not accept any responsibility for defects resulting from non-genuine parts or non workmanlike repair.

In such cases Hyundai cannot assume liability for any damage.

Continuing improvements in the design of this machine can lead to changes in detail which may not be reflected in this manual. Consult Hyundai or your Hyundai distributor for the latest available information for your machine or for questions regarding information in this manual.

BEFORE SERVICING THIS MACHINE

It is the responsibility of the owner and all service and maintenance personnel to avoid accidents and serious injury by keeping this machine properly maintained.

It also is the responsibility of the owner and all service and maintenance personnel to avoid accidents and serious injury while servicing the machine.

No one should service or attempt to repair this machine without proper training and supervision.

All service and maintenance personnel should be thoroughly familiar with the procedures and precautions contained in this manual.

All personnel also must be aware of any federal, state, provincial or local laws or regulations covering the use and service of construction equipment.

The procedures in this manual do not supersede any requirements imposed by federal, state, provincial or local laws.

Hyundai can not anticipate every possible circumstance or environment in which this machine may be used and serviced.

All personnel must remain alert to potential hazards.

Work within your level of training and skill.

Ask your supervisor if you are uncertain about a particular task. Do not try to do too much too fast.

Use your common sense.

TABLE TO ENTER SERIAL NO. AND DISTRIBUTOR

Machine Serial No.	
Engine Serial No.	
Manufacturing year	
Manufacturer Address	Hyundai Heavy Industries co., Ltd. 1 Chonha-Dong, Dong-Ku Ulsan The Republic of Korea.
Distributor for Europe Address	Hyundai Heavy Industries Europe N. V. Vossendal 11 2240 Geel Belgium
Dealer Address	

EC REGULATION APPROVED

- Noise level (EN474-1 : 2006 and 2000/14/EC) are as followings.
LWA : 104 dB(EU only)
LPA : 71 dB
- The value of vibrations transmitted by the operator's seat are lower than standard value of (EN474-1 : 2006 and 2002/44/EC)

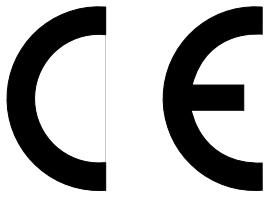

SAFETY LABELS

1. LOCATION

Always keep these labels clean. If they are lost or damaged, attach them again or replace them with a new label.

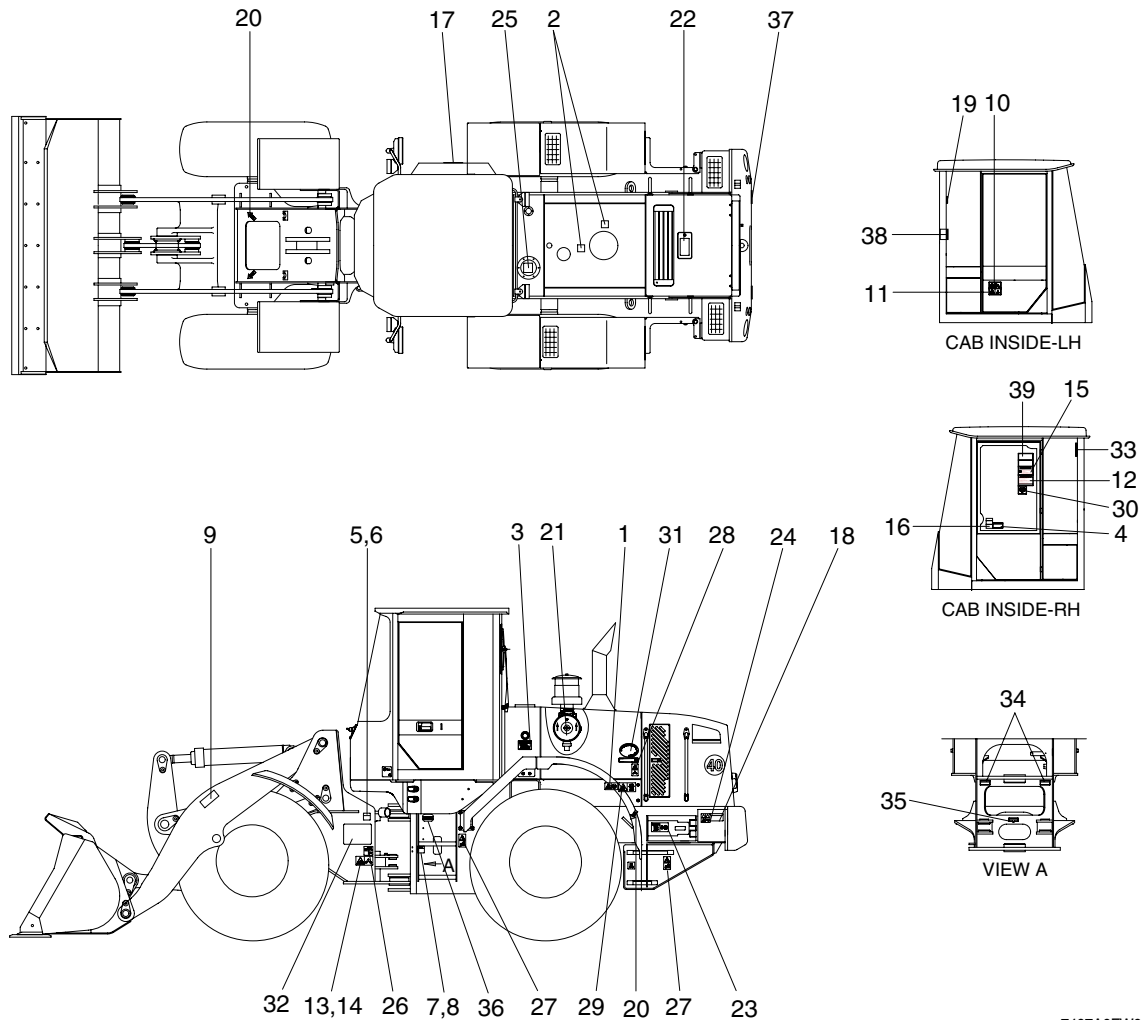

7407A0FW01

- | | | |
|------------------------|---------------------------|---------------------------|
| 1 Start motor | 14 Steering warning-RH | 27 Falling |
| 2 Turbocharger cover | 15 Reference manual | 28 Stay fix |
| 3 Hyd oil level | 16 Control ideogram | 29 Shearing-Engine hood |
| 4 Turbocharger | 17 Air conditioner filter | 30 Alternate exit |
| 5 Grease (A)/LH | 18 ECU connector | 31 Low emission engine |
| 6 Grease (B)/RH | 19 Hammer | 32 Service instruction |
| 7 Grease (C)/LH | 20 Slinging ideogram | 33 Fire extinguisher |
| 8 Grease (D)/RH | 21 Air cleaner | 34 Ride control(Optional) |
| 9 Bucket stopper | 22 Radiator cap | 35 Grease center |
| 10 Max h/reach | 23 Fueling | 36 Name plate |
| 11 Roll over | 24 Battery accident | 37 Keep clear / Reflect |
| 12 ROPS cab | 25 Hyd oil lub | 38 Rops plate |
| 13 Steering warning-LH | 26 High pressure hose | 39 Start procedure |

2. DESCRIPTION

There are several specific warning labels on this machine please become familiarized with all warning labels.

Replace any safety label that is damaged, or missing.

1) START MOTOR (Item 1)

This warning label is positioned on the left side of the engine side cover.

- ▲ Start the engine only from the operator's compartment. Never short across the starter terminals or across the batteries. Shorting could bypass the engine neutral start system. Shorting could also damage the electrical system.

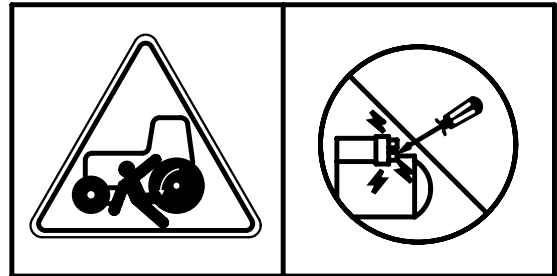

77070FW05

2) TURBOCHARGER COVER (Item 2)

This warning label is positioned on the turbocharger cover.

- ▲ Do not touch turbocharger or it may cause severe burn.



21070FW02

3) HYDRAULIC OIL LEVEL (Item 3)

This warning label is positioned on the left side of hydraulic oil tank.

- ▲ Place the bucket on the ground whenever servicing the hydraulic system.
- ※ Check oil level on the level gauge.
- ※ Refill the recommended hydraulic oil up to specified level if necessary.

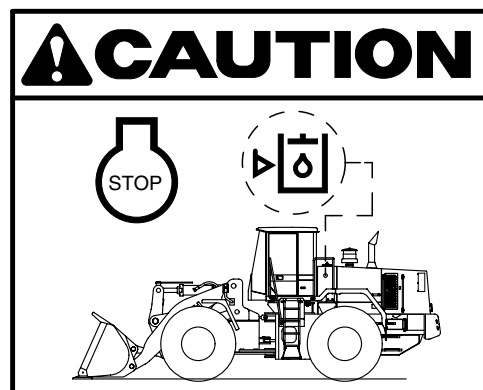

77070FW06

4) BUCKET STOPPER (Item 9)

This warning label is positioned on the middle of the boom.

- ▲ When working under or around the bucket or linkage, with bucket raised, proper support must be provided for the bucket and/or the linkage.

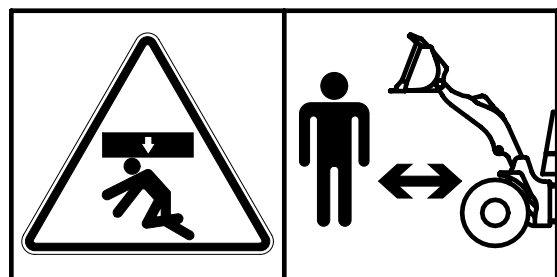

7803AFW05

5) MAX HEIGHT(Item 10)

This warning label is positioned on the left side window of the cab.

- ⚠ **Serious injury or death can result from contact with electric lines.**
An electric shock being received by merely coming into the vicinity of an electric lines, the minimum distance should be kept considering the supply voltage as page 1-6.

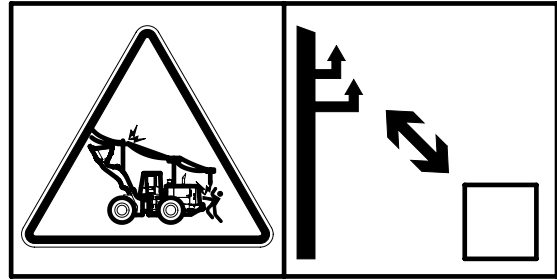

7803AFW06

6) ROLL OVER(Item 11)

This warning label is positioned on the left side window of the cab.

- ⚠ **Structural damage, an overturn, modification, alternation, or improper repair can impair this structure's protection capability thereby voiding this certification.**
- ⚠ **Always use seat belt when operating your machine. Always check the condition of the seat belt and the condition of the mounting hardware before you operate the machine.**

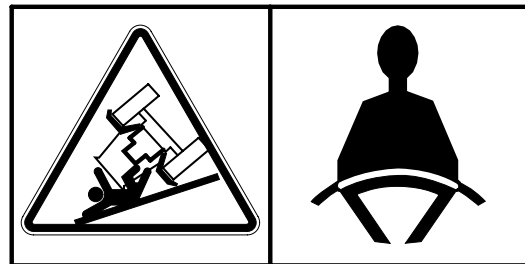

77070FW14

7) STEERING WARNING(Item 13, 14)

The warning label is positioned on the side of the front frame.

- ⚠ **No clearance for person in this area when machine turns.**
- ⚠ **Severe injury or death from crushing could occur.**

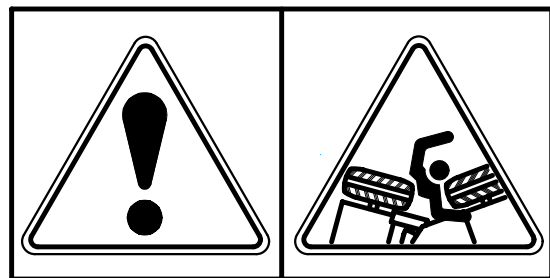

77070FW07

8) REFERENCE MANUAL (Item 15)

This warning label is positioned on the right side window of the cab.

- ▲ **Study the operator's manual before starting and operating machine.**

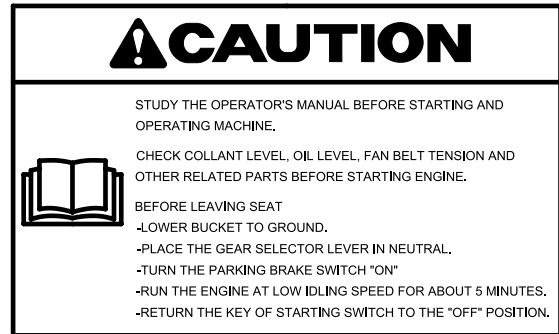

9) CONTROL IDEOGRAM (Item 16)

This warning label is positioned on the right side window of the cab.

- ▲ **Confirm the operation of control lever and working device before operating the machine.**

※ Refer to the page 4-8 for details.

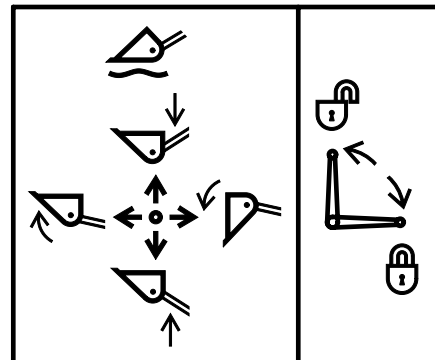

10) AIR CONDITIONER FILTER (Item 17)

This warning label is positioned on the washer tank cover.

- ※ **Periodic and proper inspection, cleaning and change of filter prolong air conditioner life time and maintain good performance.**

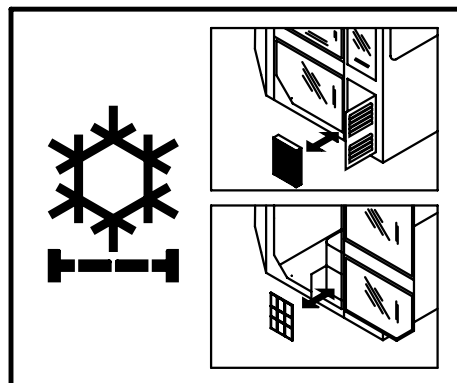

11) ECU connector (Item 18)

This warning label is positioned on the side of the battery box.

- ▲ **Before carrying out any electric welding on this machine**
 - Pull the connectors out of all electronic control units.
 - Connect the ground lead of the welding equipment as close to the welding point as possible.

※ Refer to the page 6-44 for details.

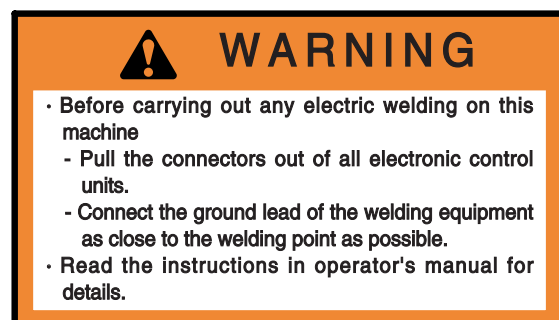

12) SLINGING IDEOGRAM (Item 20)

This label is indicate point of lifting or fixing.

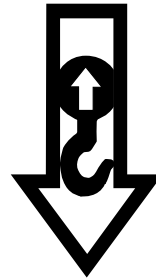

73030FW04

13) AIR CLEANER (Item 21)

The warning label is positioned on the air cleaner.

- ⚠ Periodic and proper inspection, cleaning and change of elements prolong engine life time and maintain the good performance of engine.

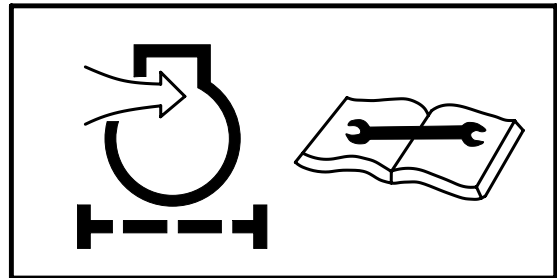

21070FW01

14) RADIATOR CAP (Item 22)

This warning label is positioned on the radiator cover.

- ⚠ Never open the filler cap while engine running or at high coolant temperature.



77070FW11

15) FUELING (Item 23)

This warning label is positioned on the left side of fuel filler neck.

- ⚠ Stop the engine when refueling. All lights or flames shall be kept at a safe distance while refueling.

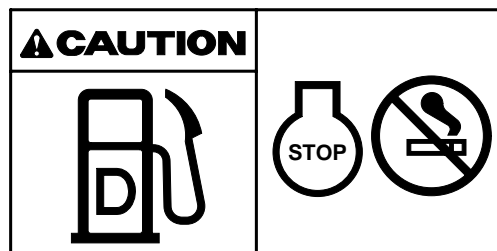

21070FW04

16) BATTERY ACCIDENT (Item 24)

This warning label is positioned on the battery box.

- ▲ Electrolyte containing sulfuric acid cause severe burns. Avoid being in contact with skin, eyes or clothes. In the event of accident flush with sufficient water, call a physician immediately.
- ※ Maintain the electrolyte at the recommended level. Add distilled water to the battery only when starting up, never when shutting down.
With electrolyte at proper level, less space may cause the gases to be accumulated in the battery.



7577A0FW05

17) HYDRAULIC OIL LUB (Item 25)

This warning label is positioned on the top of the hydraulic oil tank.

- ※ Do not mix with different brand oils.
- ▲ Never open the filler cap while engine running or at high coolant temperature.
- ▲ Loosen the cap slowly and release internal pressure completely.



21070FW04

18) STAY FIX (Item 28)

The warning label is positioned on the engine side door.

- ▲ Be sure to support the stay when the door needs to be opened.
- ▲ Be careful that the opened door may be closed by the external or natural force like strong wind.



21070FW14

19) SHEARING-ENGINE DOOR(Item 29)

This warning label is positioned on the left side of the engine side cover.

- ⚠ Don't open the engine door during the engine's running.

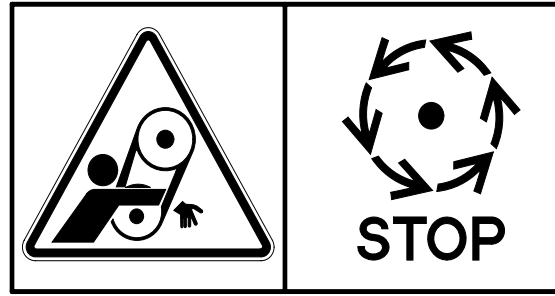

21070FW15

20) ALTERNATE EXIT(Item 30)

This warning label is positioned on the right side window of the cab.

- ※ The right door serves us an alternate exit.

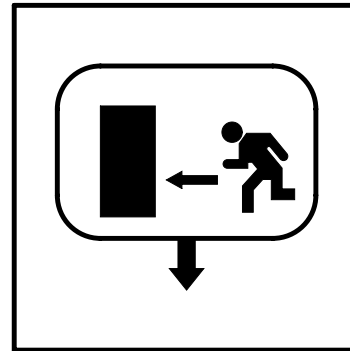

77070FW12

21) START PROCEDURE(Item 39)

This warning label is positioned on the right side window of the cab.

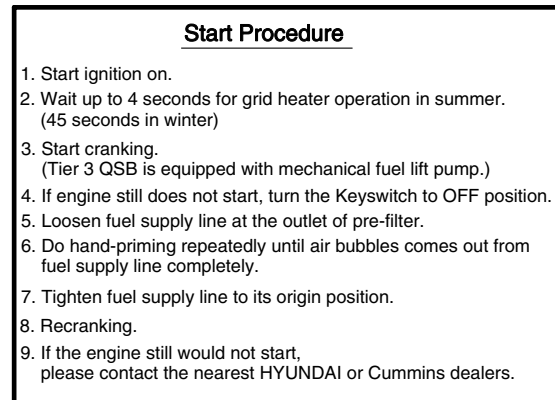

7607A0FW05

22) RIDE CONTROL(Item 34)

This warning label is positioned on the front frame.

- ※ **Before checking the boom operation system,**
 1. Bucket should be laid on the ground.
 2. Turn out the drain screw in ride control valve to release the charged oil in accumulators.

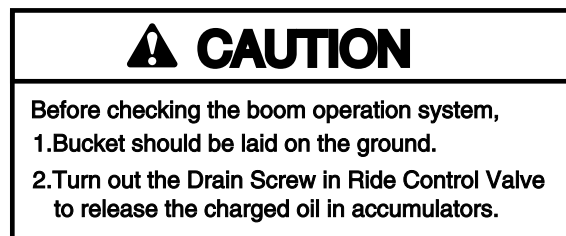

7707A0FW06

MACHINE DATA PLATE

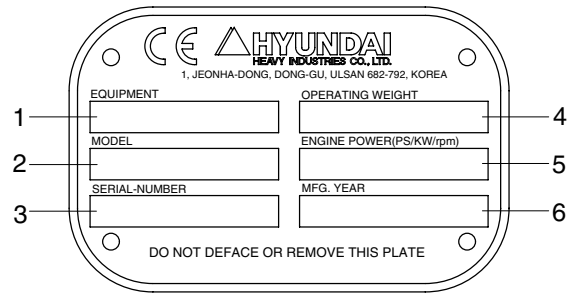
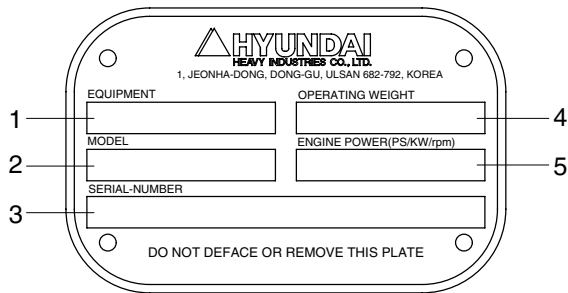

FOR EU ONLY

21090FW10

- | | | | | | |
|---|------------|---|------------------|---|--------------------|
| 1 | Equipment | 3 | Serial number | 5 | Engine power |
| 2 | Model name | 4 | Operating weight | 6 | Manufacturing year |

※ The machine serial number assigned to this particular machine and should be used when requesting information or ordering service parts for this machine from your authorized HYUNDAI dealer. The machine serial number is also stamped on the frame.

GUIDE

1. DIRECTION

The direction of this manual indicate forward, backward, right and left, when machine is on the traveling direcion.

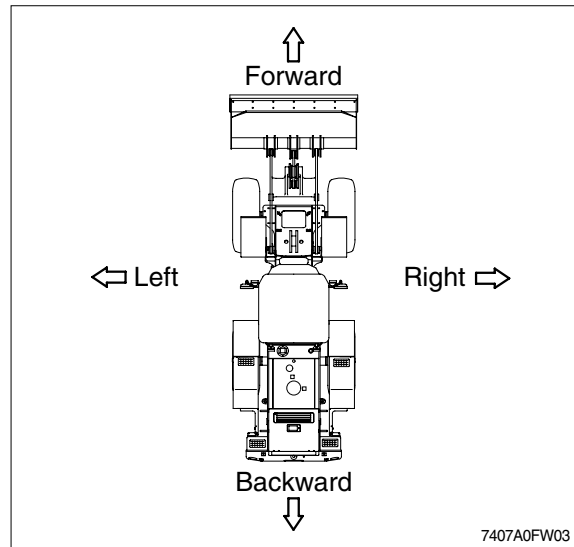

2. SERIAL NUMBER

Inform following when you order parts or the machine is out of order.

1) MACHINE SERIAL NUMBER

The numbers are located on the left side of the rear frame.

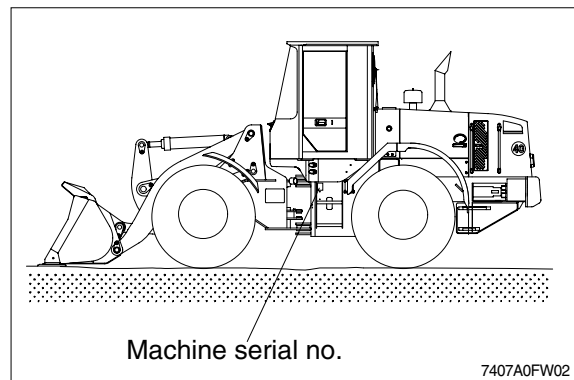

2) ENGINE SERIAL NUMBER

The numbers are located on the engine name plate.

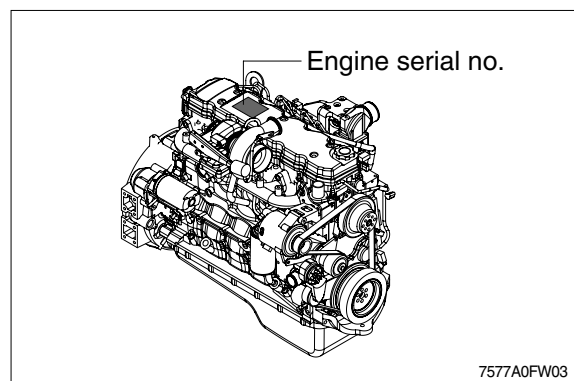

3. SYMBOLS

▲ Important safety hint.

△ It indicates matters which can cause the great loss on the machine or the surroundings.

※ It indicates the useful information for operator.