

HYUNDAI EQUIPMENT LIABILITY WARRANTY

THE WARRANTY IS THE ONLY OBLIGATION OF HYUNDAI OR A HYUNDAI DEALER TO THE PURCHASER OR ANYONE ELSE CONCERNING A PRODUCT, ITS SERVICE, ITS USE OR PERFORMANCE OR ITS LOSS OF USE OR FAILURE TO PERFORM. NEITHER HYUNDAI NOR A HYUNDAI DEALER HAVE MADE AND NEITHER WILL MAKE ANY OTHER EXPRESSED OR IMPLIED REPRESENTATION, WARRANTY OR AGREEMENT CONCERNING A PRODUCT, NEITHER HYUNDAI NOR A HYUNDAI DEALER HAVE MADE OR WILL MAKE ANY REPRESENTATION, WARRANTY OR AGREEMENT CONCERNING A PRODUCT'S MERCHANTABILITY OR OTHER QUALITY, IT'S SUITABILITY FOR PURCHASER'S PURPOSE (EVEN IF A PURCHASER HAS INFORMED HYUNDAI OR A HYUNDAI DEALER OF THAT PURPOSE), IT'S DURABILITY, PERFORMANCE OR OTHER CONDITION.

EVEN IF HYUNDAI OR A HYUNDAI DEALER WAS ADVISED OF THE POSSIBILITY OF SUCH LOSS, NEITHER HYUNDAI NOR A HYUNDAI DEALER WILL BE LIABLE TO PURCHASER OR ANYONE ELSE FOR ANY INDIRECT, INCIDENTAL CONSEQUENTIAL, PUNITIVE, ECONOMIC, COMMERCIAL, OR SPECIAL LOSS WHICH IN ANY WAY ASSOCIATED WITH A PRODUCT. THIS INCLUDES ANY LOSS OF USE OR NON-PERFORMANCE OF A PRODUCT, ANY REPLACEMENT RENTAL OR ACQUISITION COST, ANY LOSS OF REVENUE OR PROFITS, ANY FAILURE TO REALIZE EXPECTED SAVINGS, ANY INTEREST COSTS, ANY IMPAIRMENT OF OTHER GOODS, ANY INCONVENIENCE OR ANY LIABILITY OF THE PURCHASER TO ANY OTHER PERSON.

PURCHASER MAY NOT ATTEMPT TO ENLARGE ITS RIGHTS UNDER THE WARRANTY BY MAKING CLAIM, FOR INDEMNITY, FOR BREACH OF CONTRACT, FOR BREACH OF COLLATERAL WARRANTY, FOR A TORT (INCLUDING NEGLIGENCE, MISREPRESENTATION OR STRICT LIABILITY) OR BY CLAIMING ANY OTHER CAUSE OF ACTION.

THE WARRANTY IS A CONDITION OF SALE OF THE PRODUCT TO THE PURCHASER AND WILL THEREFORE APPLY EVEN IF THE PURCHASER ALLEGES THAT THERE IS A TOTAL FAILURE OF THE PRODUCT.

N.B. Read and practice your Hyundai operating and servicing instructions. Failure to do this may void the warranty.

INDEX

1. SAFETY PRECAUTIONS

2. CONTROLS

- 2. 1 Instrument Panel
- 2. 2 Control Lever Handles
- 2. 3 Seat and Seat Belt
- 2. 4 Seat Bar
- 2. 5 Parking Brake
- 2. 6 Throttle Control
- 2. 7 Lift Arm Supports
- 2. 8 Steering Controls
- 2. 9 Electrical Solenoid Auxiliary
- 2. 10 Foot Controls
- 2. 11 Hand Controls
- 2. 12 Quick - Tach
- 2. 13 Electrical Panel
- 2. 14 Two Speed Option (Not available on all models)

3. OPERATION

- 3. 1 Starting Instructions
- 3. 2 Operating Procedures
- 3. 3 Filling From a Pile
- 3. 4 Digging with a Bucket
- 3. 5 Leveling and Backfilling
- 3. 6 Auxiliary Hydraulics
- 3. 7 Lifting
- 3. 8 Towing
- 3. 9 Securing and Transporting
- 3. 10 Lowering Lift Arms
- 3. 11 Accumulator

4. MAINTENANCE

- 4. 1 Preventive Maintenance Service Schedule
- 4. 2 Service Access
- 4. 3 Daily Service Checks
- 4. 4 50 Hour Service Check
- 4. 5 150 Hour Service Check
- 4. 6 Final Drive Maintenance
- 4. 7 Hydraulic / Hydrostatic System Maintenance
- 4. 8 Engine Maintenance
- 4. 9 Air Cleaner Maintenance
- 4. 10 Engine Cooling System
- 4. 11 Electrical System
- 4. 12 Tire Maintenance
- 4. 13 Troubleshooting
- 4. 14 Hydraulic / Hydrostatic Circuit
- 4. 15 Special Tools

5. SPECIFICATIONS

- 5. 1 Loader Specifications
- 5. 2 Torque Specifications
- 5. 3 Decals

6. ATTACHMENTS AND BUCKETS

- 6. 1 Hyundai Approved Buckets and Attachments

FOREWORD

This book has been written to give the Owner / Operator necessary operating, servicing and preventative maintenance instructions on the loader.

Read this manual completely and know the loader before operating or servicing it.

Do not do any service procedures that are not in the Operator's manual.

Only service personnel that have had training in the service of this loader can do these service procedures.

Reference Information

Write the correct information for your loaders in the spaces below. Always use these numbers when referring to your loader.

Model No. _____

Serial No. _____

Dealer Name _____

Address _____

Phone _____

Throughout this manual the terms DANGER, WARNING and CAUTION are used to indicate the degree of hazard in terms of personal safety. These words will be used in conjunction with the Safety - Alert symbol, a triangle with an exclamation mark.

Throughout this manual, the term IMPORTANT is used

- * To indicate that instructions are necessary before operating or servicing the loader.
- * To show important procedures which must be followed to prevent damage to the loader or attachment.

| | |
|---|---|
|  DANGER | This warning indicates an immediate hazard which WILL result in severe personal injury or death. |
|---|---|

| | |
|--|--|
|  WARNING | This warning indicates hazards or unsafe practices which COULD result in severe personal injury or death. |
|--|--|

| | |
|--|--|
|  CAUTION | This warning indicates hazards or unsafe practices which COULD result in minor personal injury or product or property damage. |
|--|--|

| | |
|------------------|--|
| IMPORTANT | Instructions are necessary before operating or servicing this machine. Read the operators manual and service decals on the loader. Follow warnings and instructions in this manual when making repairs, adjustments or servicing. Check for correct operation after adjustments and repairs. |
|------------------|--|

| | |
|------------------|--|
| IMPORTANT | This notice shows important procedures which must be followed to prevent damage to the loader or attachment. |
|------------------|--|

1. SAFETY PRECAUTIONS

The following precautions are suggested to help prevent accidents.

A careful operator is the best operator. Most accidents can be avoided by observing certain precautions. Read and take the following precautions before operating this loader to help prevent accidents. Equipment should be operated only by those who are responsible and instructed to do so.

1. Read this manual carefully before using the loader. Working with unfamiliar equipment can lead to accidents.
2. Do not allow anyone to ride on the loader with the operator.
3. Make sure the seat bar is installed and functioning at all times.
4. Never run the engine in a closed building without adequate ventilation, as the exhaust fumes can cause death.
5. Always fasten the seat belt around you before starting the engine. Never fasten the seat belt behind you.
6. Never attempt to start the engine while standing beside the unit unless as specified in this manual or under specific service and backhoe operation procedures. Start the engine only while sitting in the operator's seat with the seat belt fastened around you. Always check to make certain that the seat cushion is secured to the frame.
7. Keep the operator's area free of debris.
8. Never enter or leave the loader while the engine is running. Always lower the lift arms down against the frame, drop the attachment down to contact the ground, set the parking brake and shut off the engine prior to leaving the loader.
9. If the unit is equipped with a cab enclosure kit always close the door prior to operating the loader lift arms.
10. Do not operate the loader unless all safety equipment, shields, seat belt, seat bar, hydraulic controls, parking brake, operator guard, and lift arm supports are working properly, as well as all safety and instruction decals are in place.
11. Do not dismount from the loader and leave the loader lift arms raised, unless following specific service procedures. Always lower the lift arms down against the frame and drop the attachment down to contact the ground.
12. Always be watchful of bystanders when operating the loader.
13. Always carry the attachment low for maximum stability and visibility.
14. Exercise extreme caution when operating the loader with a raised attachment.
15. Never attempt to lift loads in excess of loader capacity.
16. Check that the foot pedals are locked before getting out of the operator's seat.
17. Keep both hands on the control levers while the loader is in motion.

MAINTENANCE

OPERATING THE LOADER

1. Always drive the loader at speeds compatible with safety, especially when operating over rough ground, unfamiliar terrain, when crossing ditches or when turning.
2. Avoid jerky turns, starts, stops, or reverses.
3. Use care when operating on steep grades to maintain proper stability.
4. Do not turn the loader while the lift arms are in the raised position.
5. Be careful when driving through door openings or under overhead objects. Always make sure there is sufficient clearance for the operator's guard.
6. When travelling on public roads, know the local rules and regulations and make sure your loader is equipped with the proper safety equipment.
7. Always be sure of water, gas, sewage and electrical line locations before you start to dig.
8. Watch out for overhead and underground high-voltage electrical lines when operating the loader.
9. Always park the loader on level ground where possible. If the loader is to be parked on an incline, always lower the attachment so it contacts the ground, set the parking brake and block the wheels.
10. Do not leave the loader when it is in motion.
1. Stop the engine before performing any service on the loader.
2. Never refuel the loader while smoking or with the engine hot or running.
3. Replace all missing, illegible or damaged safety and warning decals. See Section 5.3 for list.
4. Do not modify or alter, or permit anyone to modify or alter this loader or any of its components or any loader function.
5. Do not bypass the safety system. Consult your **Hyundai** Equipment Dealer if your safety controls are malfunctioning.
6. Do not make mechanical adjustments while the loader is in motion or when the engine is running. However, if minor engine adjustments must be made, securely block the loader with the wheels clear of the ground, and use extreme caution.
7. Do not attempt to repair or tighten hydraulic hoses when the system is under pressure, when the engine is running or when the lift arms are raised.
8. Do not get under the attachment or lift arms or reach through the lift arms when they are raised.
9. Never attach the chains or ropes to the operator's guard for pulling purposes, as the loader can tip over.
10. Whenever servicing or replacing pins in cylinder ends, buckets, etc., always use a brass drift and a hammer. Failure to do so could result in injury from flying metal fragments.
11. Cooling system operates under pressure which is controlled by the radiator cap. It is dangerous to remove the cap while system is hot. Always turn cap slowly to the first stop and allow the pressure to escape before removing the cap entirely.
12. Keep the operator and foot pedal areas free from debris.
13. For lifting and towing instructions, refer to Sections 3.7 and 3.8 of this manual.

1. SAFETY PRECAUTIONS



WARNING

To avoid personal injury, lower the lift arms, shut off the engine, raise the seat bar and cycle the controls to ensure they are locked. Then, unlatch the seat belt and exit the loader. Do not enter or exit with the engine running unless as specified in this manual or under specific service and backhoe operating procedures.



WARNING

To prevent personal injury do not operate the loader without lowering the safety bar, fastening the seat belt and keeping feet on the control pedals or cab floor.



WARNING

To prevent personal injury do not start the engine unless you are in the seat with the seat belt fastened around you.

IMPORTANT

This engine is equipped with glow plugs. Do not use ether or any high energy fuels to assist starting.

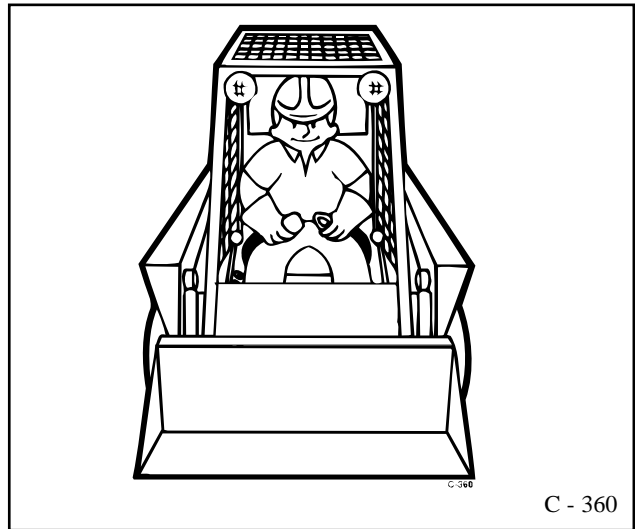

START SAFELY

1. Sit in the operator's seat and adjust it so you can operate all of the controls properly.
2. Adjust the seat and fasten the seat belt. Cycle the controls to make sure they are in the locked or neutral position. Lower the seat bar.
3. Know the exact starting procedure for your machine. See Section 3 for the manufacturer's instructions for starting.

PARK SAFELY

Select level ground whenever possible. If you must park on a slope or incline, position the machine at right angles to the slope. Lower the attachment to the ground, engage the parking brake and block the wheels (C359).

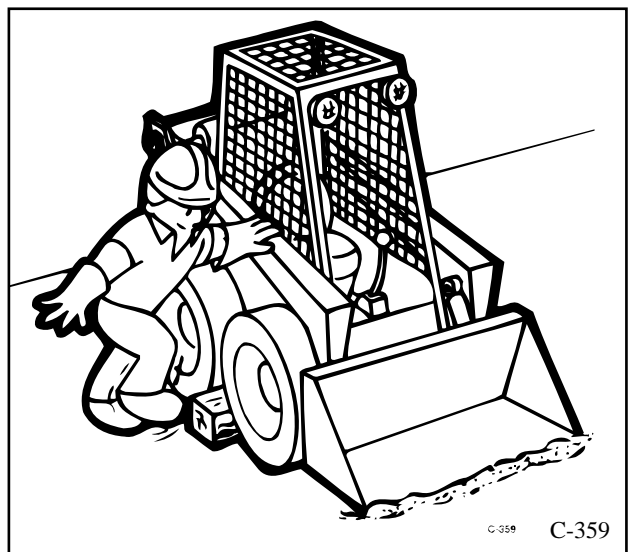

2. CONTROLS

2. CONTROLS

- 2. 1 Instrument Panel
- 2. 2 Control Lever Handles
- 2. 3 Seat and Seat Belt
- 2. 4 Seat Bar
- 2. 5 Parking Brake
- 2. 6 Throttle Control
- 2. 7 Lift Arm Supports
- 2. 8 Steering Controls
- 2. 9 Electrical Solenoid Auxiliary
- 2. 10 Foot Controls
- 2. 11 Hand Controls
- 2. 12 Quick - Tach
- 2. 13 Electrical Panel
- 2. 14 Two Speed Option (Not available on all models)

2. CONTROLS

2.1 INSTRUMENT PANEL

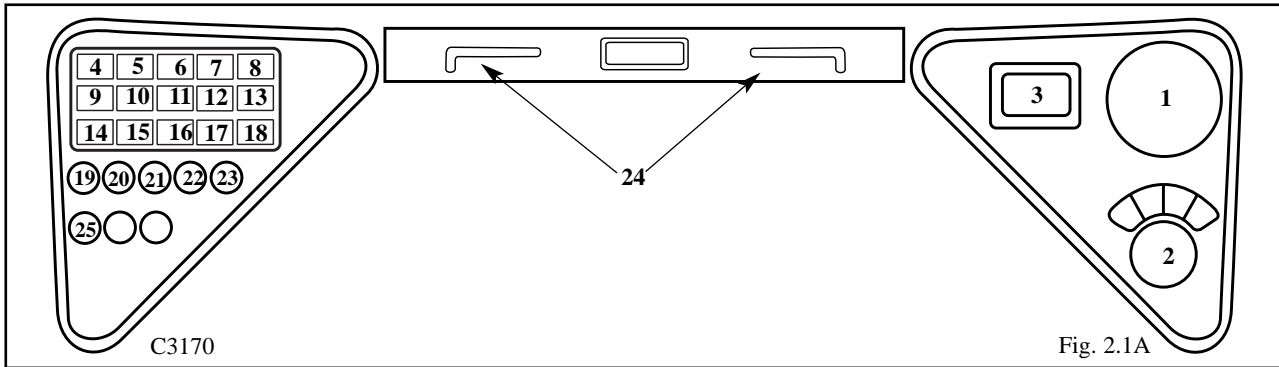

1. Fuel Gauge: The fuel gauge indicates the quantity of fuel remaining in the fuel tank.

2. Ignition Switch: The ignition switch is a four (4) position switch: 'OFF', 'PRE-HEAT', 'RUN' and 'START'. Turn the key counter clockwise to engage engine 'PRE-HEAT'. Turn the key clockwise to the 'START' position, this engages the starter. The key will be in the 'RUN' position when released. Turn the key to 'OFF' to shut off the engine and remove the key.

3. Hour Meter: The hour meter records the number of engine operating hours and has a total of 9999.9 hours.

4. Left Signal Indicator Light: This light will illuminate when the operator uses the optional left signal (**not available on all models**).

5. Auxiliary Front Indicator Light: This light will illuminate when the loader auxiliary hydraulic front switch (**not available on all models**) is turned on.

6. Hi-Flow Hydraulics Indicator: This light will illuminate when the loader hi-flow hydraulics (**not available on all models**) are in use.

7. Work Lights Indicator: This light will illuminate when the loader work lights are turned on. This will serve as a reminder to turn them OFF when the loader is not in use.

8. Right Signal Indicator Light: This light will illuminate when the operator uses the optional right signal (**not available on all models**).

9. Hydraulic Oil Temperature Indicator: This light will illuminate when the oil temperature has exceeded recommended levels. Shut off the engine immediately and determine the cause.



10. Brake Indicator Light: The brake light will illuminate when the parking brake is engaged.

11. Seat Belt Indicator Light: This light will illuminate when the seat belt is unfastened.

12. Hydraulic Oil Pressure Indicator Light: This light will illuminate when there is low hydraulic oil pressure. If this light illuminates, shut off the engine and determine the cause (**not available on all models**).

13. Rotary Beacon Indicator: This light will illuminate when the optional rotary beacon (**not available on all models**) is turned on.

14. Engine Oil Pressure Indicator: This light will illuminate when the engine loses lubrication pressure. Shut off the engine immediately and determine the cause.

15. Coolant Temperature Indicator Light: This light will illuminate if there is a rise in engine temperature. If this occurs, shut off the engine immediately and determine the cause.

16. Alternator Indicator Light: This light will illuminate when the alternator is not producing sufficient current.

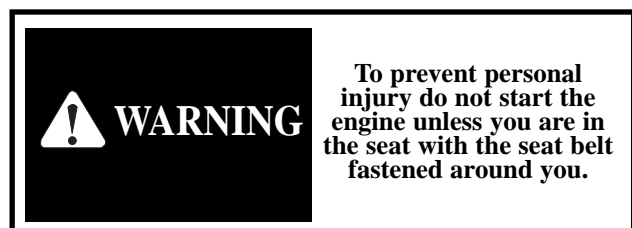

2. CONTROLS

IMPORTANT

Fully retract lift arm support pins before raising or lowering lift arms.

17. Air Cleaner Indicator Light: This light will illuminate when there is an obstruction in the intake or when the air filter needs servicing. If this light illuminates, stop the engine and service the cleaner (see section 4.9).

18. Pre-heat Indicator Light: This light will illuminate when the ignition key is turned counter clockwise to activate the engine glow plugs.

19. Dipped Beam Light Switch: This switch is a toggle switch. Push up to turn the dipped beam lights on. These lights are located on the front of the loader (**not available on all models**).

20. Rotary Beacon Light Switch: This switch is a toggle switch. Push up to turn the optional rotary beacon light on (**not available on all models**).

21. Hazard Light Switch: This switch is a toggle switch. Push up to turn the optional hazard light on (**not available on all models**).

22. Work Light Switch: This switch is a toggle switch. Push up to turn the optional work light on (**not available on all models**). The light is located on the back of the loader.

23. Auxiliary Hydraulics Front Switch: This switch is a toggle switch. Push up to provide a continuous flow of hydraulic oil to the quick couplers when using an attachment (**not available on all models**).

24. Lift Arm Supports: For safety while performing service or maintenance, the loader is equipped with a lift arm support device. Refer to section 2.7 for details.

25. Hi-Flow Hydraulic Switch: This switch is a toggle switch. Push up to turn the hi-flow hydraulics on (**not available on all models**).

2.2 CONTROL LEVER HANDLES

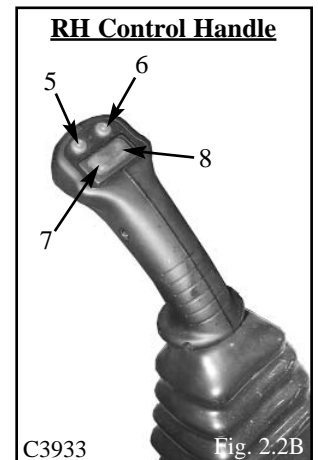
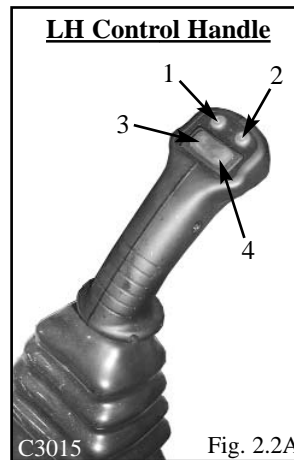

1. Two Speed Switch (not available on all models): This switch provides alternate switching. Press to activate Hi-Speed function. Pressing and releasing the switch a second time will return the loader to the Low-Speed function. (See Fig. 2.2A)

2. Horn Switch (not available on all models): This switch is a momentary switch. Pressing and holding the switch will activate the horn. Releasing the switch deactivates the horn. (See Fig. 2.2A)

3 & 4. Electric Solenoid Auxiliary Switch: This switch is a momentary switch. Pressing and holding the switch in position 3 provides hydraulic flow to the female quick coupling. Pressing and holding the switch in position 4 provides hydraulic flow to the male quick coupling. Releasing the switch returns it to neutral, stopping the hydraulic flow. (See Fig. 2.2A)

5. LH Directional Signal Switch (not available on all models): This switch is a momentary switch. Pressing and holding this switch will activate the LH turn signal. Releasing the switch deactivates the LH turn signal. (See Fig. 2.2B)

6. RH Directional Signal Switch (not available on all models): This switch is a momentary switch. Pressing and holding this switch will activate the RH turn signal. Releasing the switch deactivates the RH turn signal. (See Fig. 2.2B)

7 & 8. Hi-Flow Hydraulic Switch (not available on all models): This switch is a momentary switch. Pressing and holding the switch in position 7 activates the hi-flow hydraulics to the male quick coupling. Pressing and holding the switch in position 8 activates the hi-flow hydraulics to the female quick coupling. Releasing the switch returns it to neutral and stops the hi-flow hydraulic flow. (See Fig. 2.2B)

2. CONTROLS

2.3 SEAT AND SEAT BELT

The loader is equipped with a deluxe seat. The seat can be adjusted forward or back for operator comfort. (Fig. 2.3A).

For your safety the loader is equipped with a seat belt. Before starting the loader adjust and fasten the seat belt (Fig. 2.3B) around you. The seat and seat belt also have integrated safety lock switches whereby the operator must be seated in the seat with the seat belt securely fastened around them and seat bar lowered before the loader hydraulics can be operated.

NOTE: The two-speed loader comes equipped with a standard three point seat belt. (Fig. 2.3C)

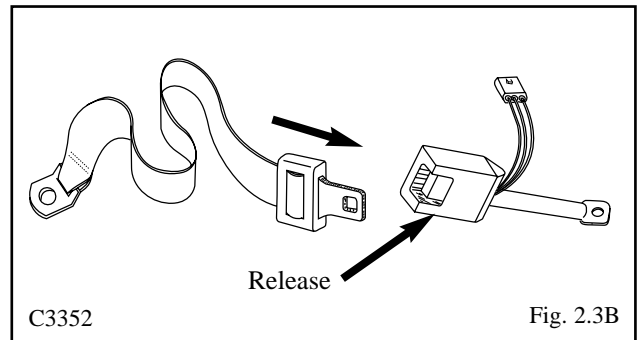
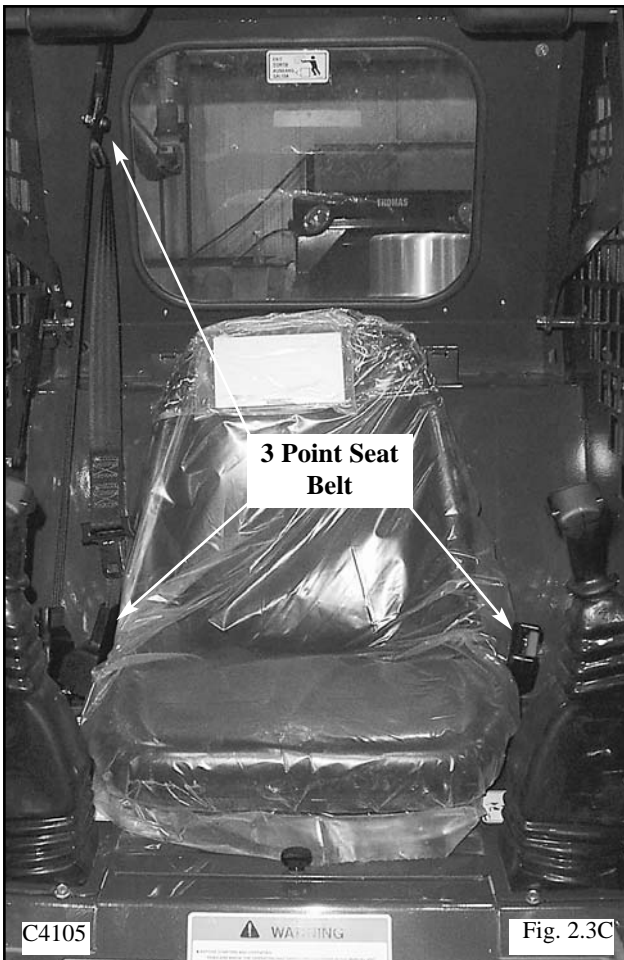

2. CONTROLS

2.4 SEAT BAR

For operator protection the loader is equipped with a seat bar.

The loader must be started with the operator seated in the loader and the seat bar in the up position. To raise the seat bar, lift up on the bar (Fig. 2.4A). In the up position, the seat bar activates the parking brake.

When down (Fig. 2.4B), the seat bar releases the park brake and the hydraulic controls of the lift and tilt circuits.

Before exiting the loader always check the controls by cycling them to ensure that they are in the neutral position.

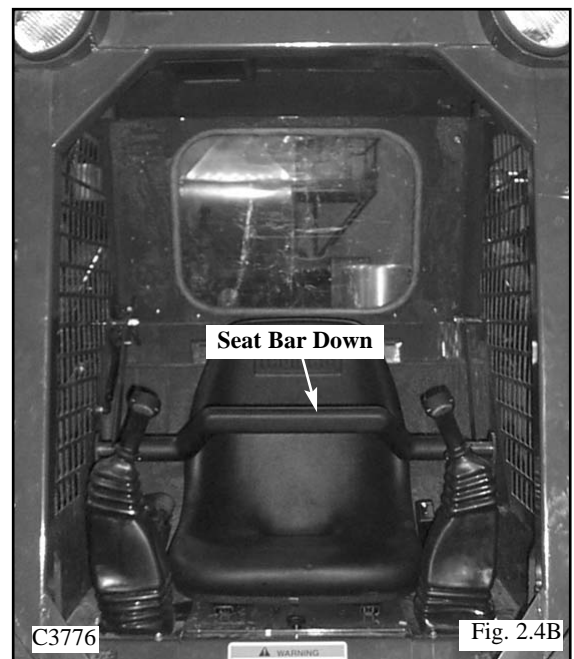
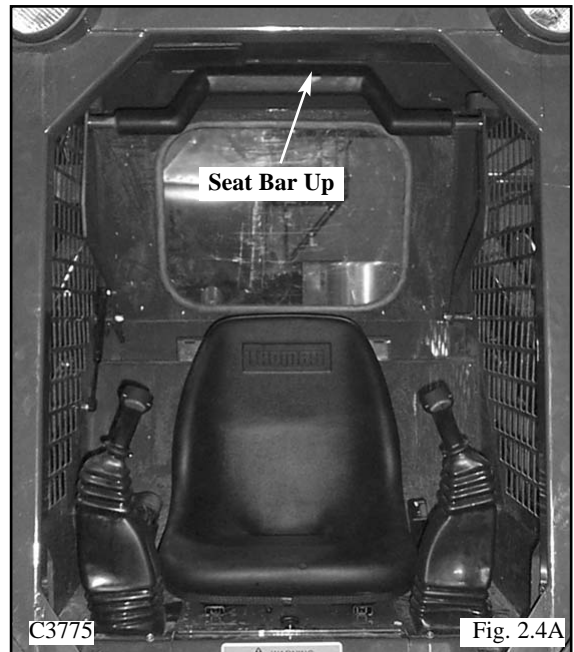

| | |
|---|--|
|  | <p>To avoid personal injury, lower the lift arms, shut off the engine, raise the seat bar and cycle the controls to ensure they are locked. Then, unlatch the seat belt and exit the loader. Do not enter or exit with the engine running unless as specified in this manual or under specific service and backhoe operating procedures.</p> |
|---|--|

2. CONTROLS

2.5 PARKING BRAKE

The loader is equipped with park brakes, located inside the torque motors. The brakes are activated and deactivated by the seat bar, via charge pressure. When the seat bar is in the up position, the brake is activated (Fig. 2.5A). When the seat bar is in the down position, the brake is off (Fig. 2.5B).

The loader has a parking brake indication light to warn that the brake is engaged.

2.6 THROTTLE CONTROL

The diesel engine throttle control, is a push / pull / turn to lock, located on the left hand side of the loader next to the steering control lever (Fig. 2.6) Engine start and stop are controlled electrically by the ignition key.

Before shutting off the engine, return the throttle control to idle position and allow the engine to cool at least 2 minutes.

Pulling upward, out, will increase engine speed. Turn the handle to lock. Turn the handle to release from position, push down to lower engine speed.

The engine should always be operated at full speed and the loader travel speed controlled with the steering control levers. (See Section 2.8).

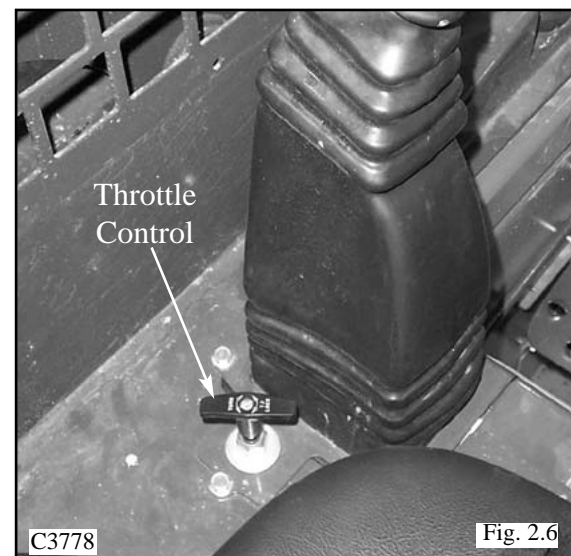
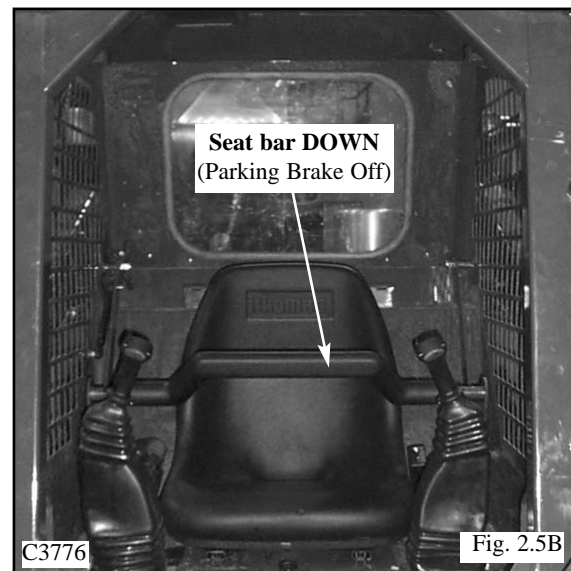
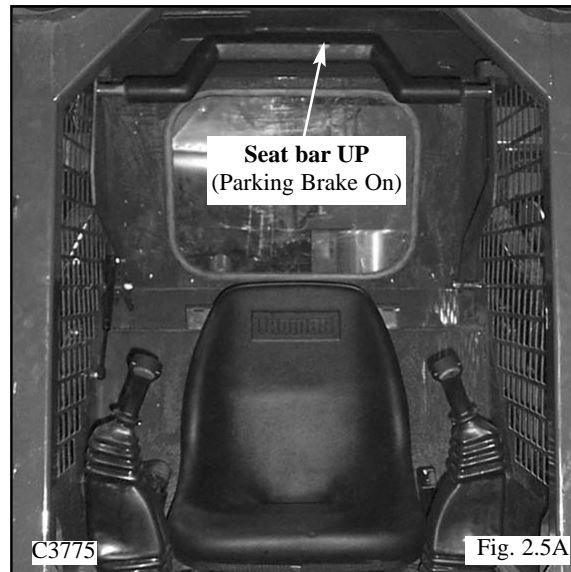

| | |
|--|--|
| | <p>To avoid personal injury, lower the lift arms, shut off the engine, raise the seat bar and cycle the controls to ensure they are locked. Then, unlatch the seat belt and exit the loader. Do not enter or exit with the engine running unless as specified in this manual or under specific service and backhoe operating procedures.</p> |
|--|--|

2. CONTROLS

2.7 LIFT ARM SUPPORTS

For your safety, the loader is equipped with lift arm supports to be used while performing regular service or maintenance work.

The lift arm supports, when extended, prevent the lift arms from dropping if hydraulic pressure is relieved or the foot control pedals are accidentally cycled.

To operate the lift arm supports, first remove any bucket or attachment from the quick - tach, raise the lift arms to full height and shut OFF the engine. Push the two lift arm support pin handles located directly in front of the operator at the top of the operator compartment (Fig. 2.7A) outward extending the lift arm locking pins (Fig. 2.7B). Slowly lower the lift arms down onto the pins. To retract the support pins, first lift the lift arms off of the pins before retracting.

IMPORTANT

Fully retract the lift arm supports before raising or lowering lift arms.

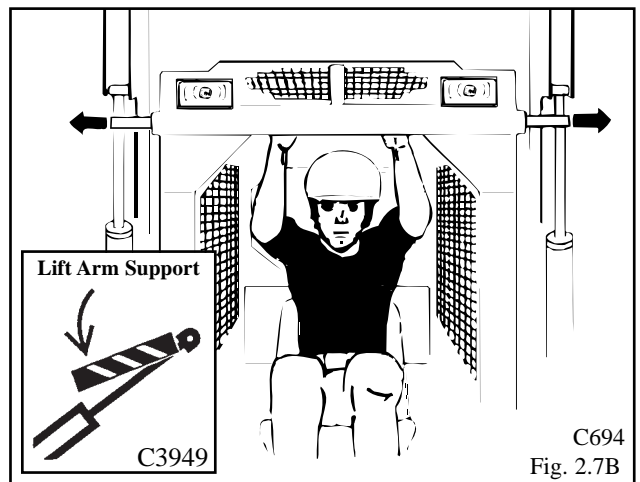
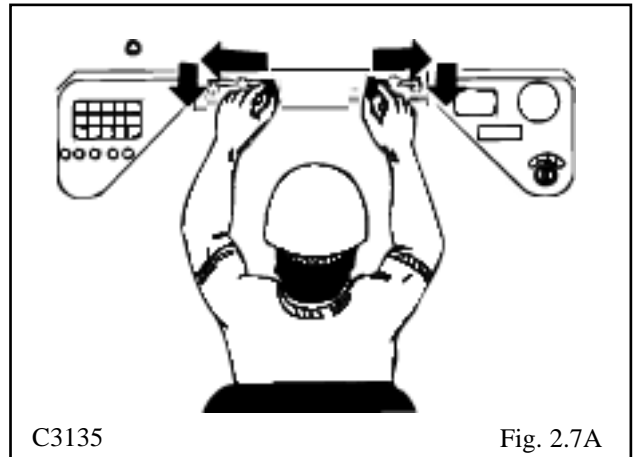

2. CONTROLS

2.8 STEERING CONTROLS

The two steering levers control speed, direction and turning of the loader. The R.H. lever controls the wheels on the R.H. side of the loader and the L.H. lever the L.H. wheels. Loader speed is controlled by the amount each lever is moved from centre or neutral position. (Fig. 2.8A) The further away from neutral, the faster the travel speed. For maximum power and slow travel speed move the control levers only a small amount.

To drive the loader forward in a straight line, move both control levers forward the same amount (Fig. 2.8B).

To drive the loader in reverse in a straight line, move both control levers back the same amount (Fig. 2.8B).

The loader is turned by moving one lever further forward than the other. To turn right, move the left lever further than the right lever. To turn left, move the right lever further than the left lever (Fig. 2.8B).

For the loader to turn or "skid-steer" within its own length, one lever is moved forward and the other back. This causes the wheels on one side to turn forward and the wheels on the other side to reverse, turning the loader (Fig. 2.8B).

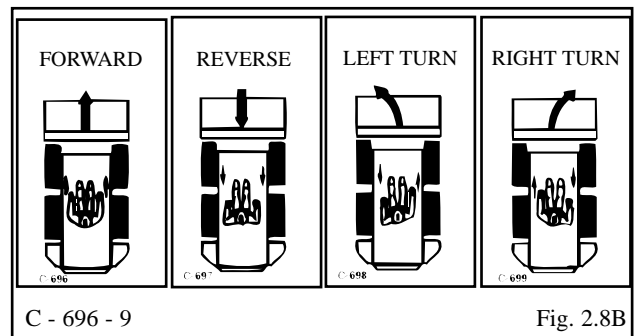
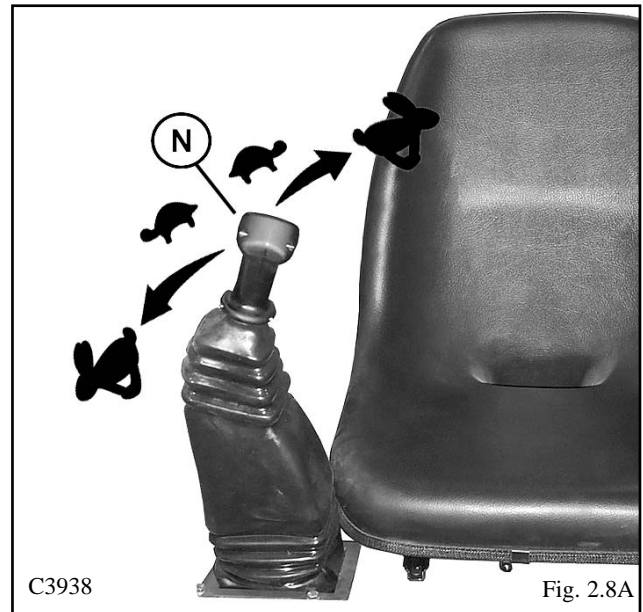

| | |
|---|--|
|  | WARNING To avoid personal injury do not start the engine unless you are in the seat with the seat belt fastened around you, unless as specified in this manual or under specific service and backhoe operating procedures. |
|---|--|

| | |
|---|---|
|  | WARNING To avoid personal injury always carry the load low. |
|---|---|

| | |
|------------------|--|
| IMPORTANT | Return the auxiliary hydraulic foot pedal to neutral position when not in use. |
|------------------|--|

2. CONTROLS

2.9 ELECTRICAL SOLENOID AUXILIARY

CONTROLS

Auxiliary Hydraulic (solenoid operated – standard).

A switch located in the L.H. steering control lever (Fig. 2.9A) is used to engage the loader's auxiliary hydraulic circuit to power attachments such as post hole augers, sweepers etc. Pressing and holding the switch in position 1 (Fig. 2.9A) provides hydraulic flow to the female quick connect coupling located at the front of the lift arms (Fig. 2.9C). Releasing the switch returns the auxiliary hydraulic circuit to neutral, stopping hydraulic flow.

Pressing and holding the switch in position 2 (Fig. 2.9A) provides hydraulic flow to the male quick connect coupling located at the front of the lift arms (Fig. 2.9C). Releasing the switch returns the auxiliary hydraulic circuit to neutral, stopping hydraulic flow.

For continuous flow to the auxiliary hydraulic circuit, a toggle switch is located on the L.H. instrument panel (Fig. 2.9B). Placing the switch in the "ON" position provides continuous hydraulic flow to the female quick connect coupling located at the front of the lift arms (Fig. 2.9C). To stop hydraulic flow to the auxiliary hydraulic circuit, return the switch to the "OFF" position (Fig. 2.9B). When the switch on the instrument panel is in the "ON" position, the switch located in the L.H. control lever is not operable.

NOTE: See Section 2.2 for information on the control handles.

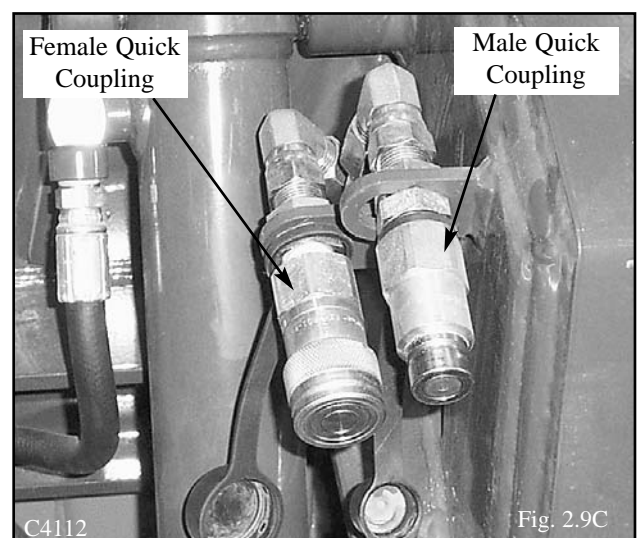
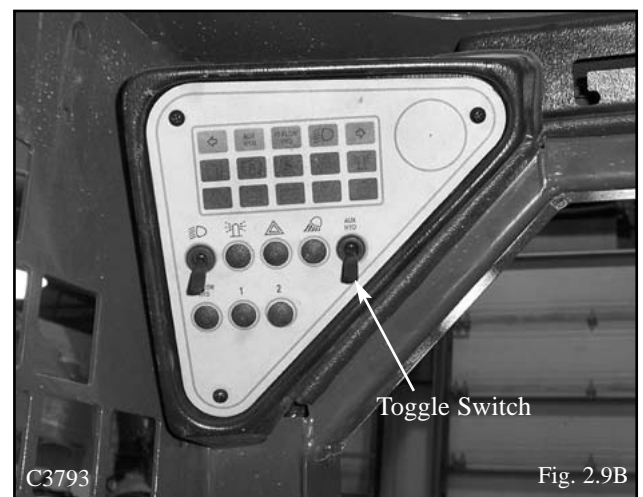
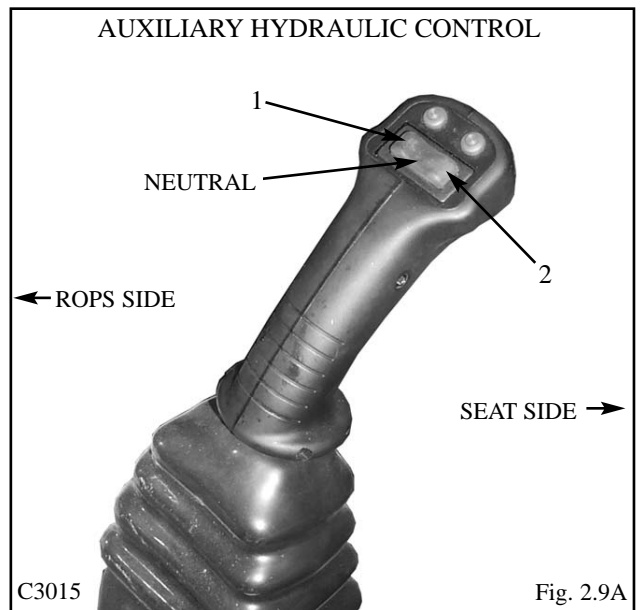

**WARNING**

To avoid personal injury, lower the lift arms, shut off the engine, raise the seat bar and cycle the controls to ensure they are locked. Then, unlatch the seat belt and exit the loader. Do not enter or exit with the engine running unless as specified in this manual or under specific service and backhoe operating procedures.

2. CONTROLS

2.10 FOOT CONTROLS

Operation of the lift cylinders and bucket tilt cylinders are controlled by foot pedals (Fig. 2.10A) connected to a hydraulic control valve. The hydraulic control valve is a series type valve which allows simultaneous use of both the lift and bucket tilt circuits.

Lift – The L.H. pedal is the lift control (Fig. 2.10A). To raise the lift arms press on the heel (2) of the pedal. To lower the lift arms press on the toe (1) of the pedal. Firm pressure on the toe (1) of the pedal will lock the lift arms in float position. This allows the bucket to follow the ground as the loader moves backward.

Bucket Tilt – The R.H. pedal is the bucket tilt (dump) control. Pressing on the toe (3) of the pedal will dump the bucket. Pressing on the heel (4) of the pedal will roll the bucket back.

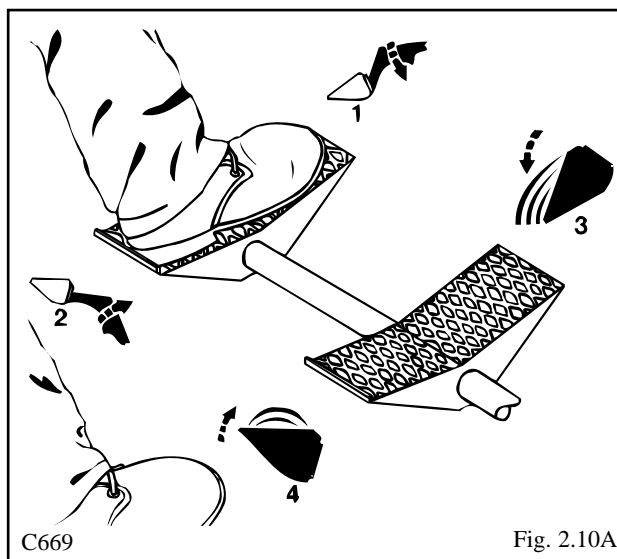

2.11 HAND CONTROLS

Hand controls to operate the loader's lift arm and bucket hydraulic system as well as the loader's travel speed and direction are available. Refer to Section 2.8 for instruction on steering controls.

LIFT ARM AND BUCKET CONTROLS

The right hand lever controls the bucket tilt cylinders (Fig. 2.11A). Moving the control lever to the right causes the bucket to dump. Moving the lever to the left rolls the bucket to the carry position.

Moving the left hand control lever (Fig. 2.11A) to the left will cause the lift cylinders to extend, raising the loader's lift arms. Moving the control lever to the right causes the lift cylinders to retract, lowering the lift arms. Moving the control lever to extreme right will place the lift arms in float position. This allows the bucket to follow the contour of the ground as the loader moves backward.

When the control levers are released they will automatically return to the neutral position stopping all hydraulic movement and travel speed. Before exiting the loader, lower the lift arms completely down to the frame and ground the attachment. Then shut off the engine. Move both levers to the left and right to ensure the hydraulic controls are locked before you get out of the loader.

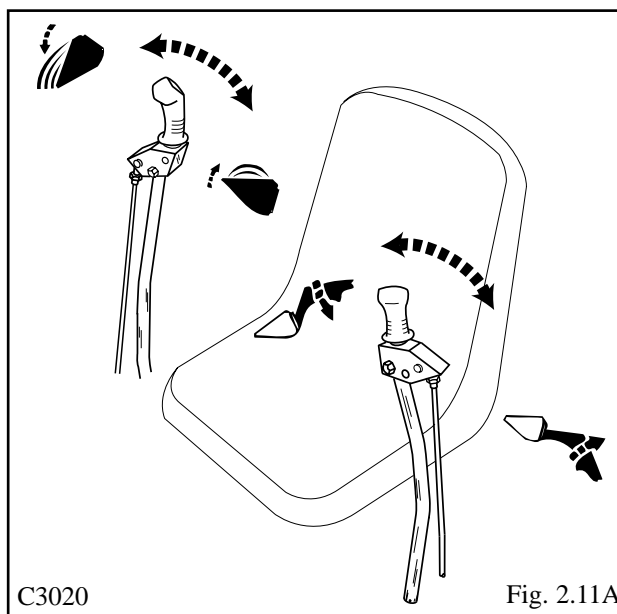

IMPORTANT

Return the auxiliary hydraulic control to the neutral position when not in use.



WARNING

To prevent personal injury do not operate the loader without lowering the safety bar, fastening the seat belt and keeping feet on the control pedals or cab floor.



WARNING

To avoid personal injury, lower the lift arms, shut off the engine, raise the seat bar and cycle the controls to ensure they are locked. Then, unlatch the seat belt and exit the loader. Do not enter or exit with the engine running unless as specified in this manual or under specific service and backhoe operating procedures.

2. CONTROLS

2.12 QUICK - TACH

The quick - tach, which is standard equipment, allows changing from one attachment to another quickly without having to remove bolt or pins.

To operate, lift the locking lever (1) up to completely retract the locking pins (2) (Fig.2.12A). Tilt the quick - tach frame forward (Fig. 2.12B) with the bucket tilt cylinders and drive into the attachment. Retract the bucket tilt cylinders (Fig. 2.12C) which will line up the bottom of the attachment with the quick - tach lock pins. Shut off the engine.

Push the locking lever (1) fully down (Fig. 2.12D) extending the lock pins (Fig. 2.12E item 2) through the attachment and securing the attachment.

Before operating the attachment check that the locking pins are correctly engaged.

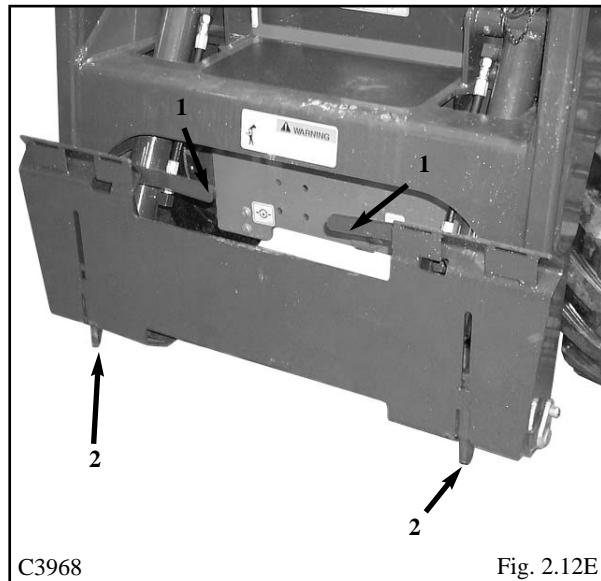
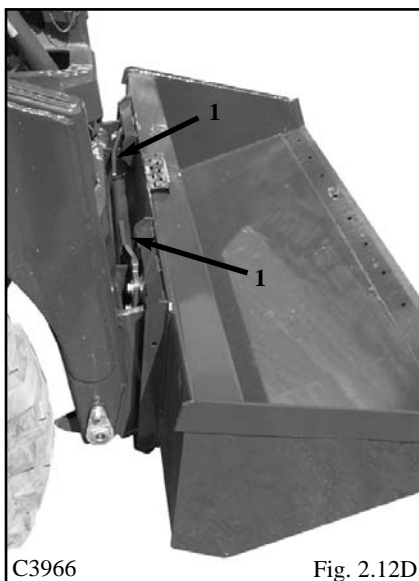
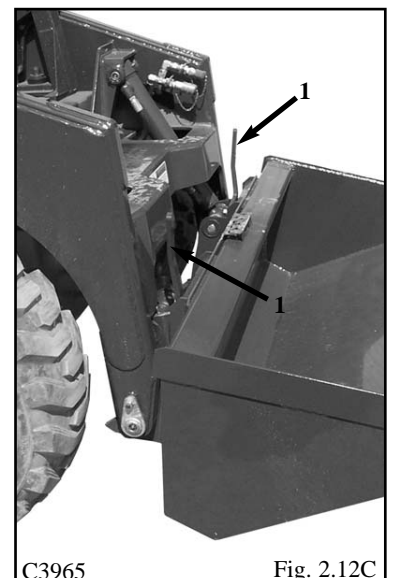
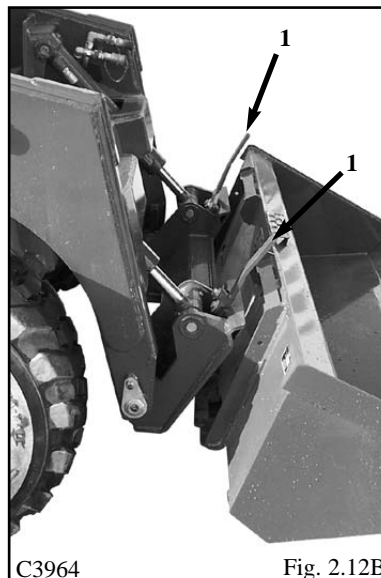
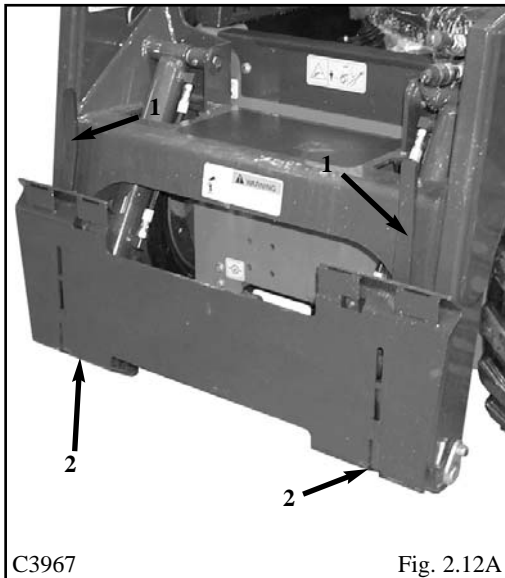

2. CONTROLS

2.13 ELECTRICAL PANEL

The loader is equipped with a 12 volt, negative ground electrical system. The fuse and relay panel are located in the engine compartment on the engine cover. The panel consists of the following:

1. Engine Pre-Heater Relay.
2. Starter Relay.
3. Fuse Panel.

FUSE PANEL (3)

4. Electric Fuel Solenoid Shutoff (15A)
5. Alternator (10A)
6. Electric Auxiliary (10A)
7. Spare
8. Spare
9. Valve Locks (10A)
10. Horn (Optional) (10A)
11. Spare
12. Ground

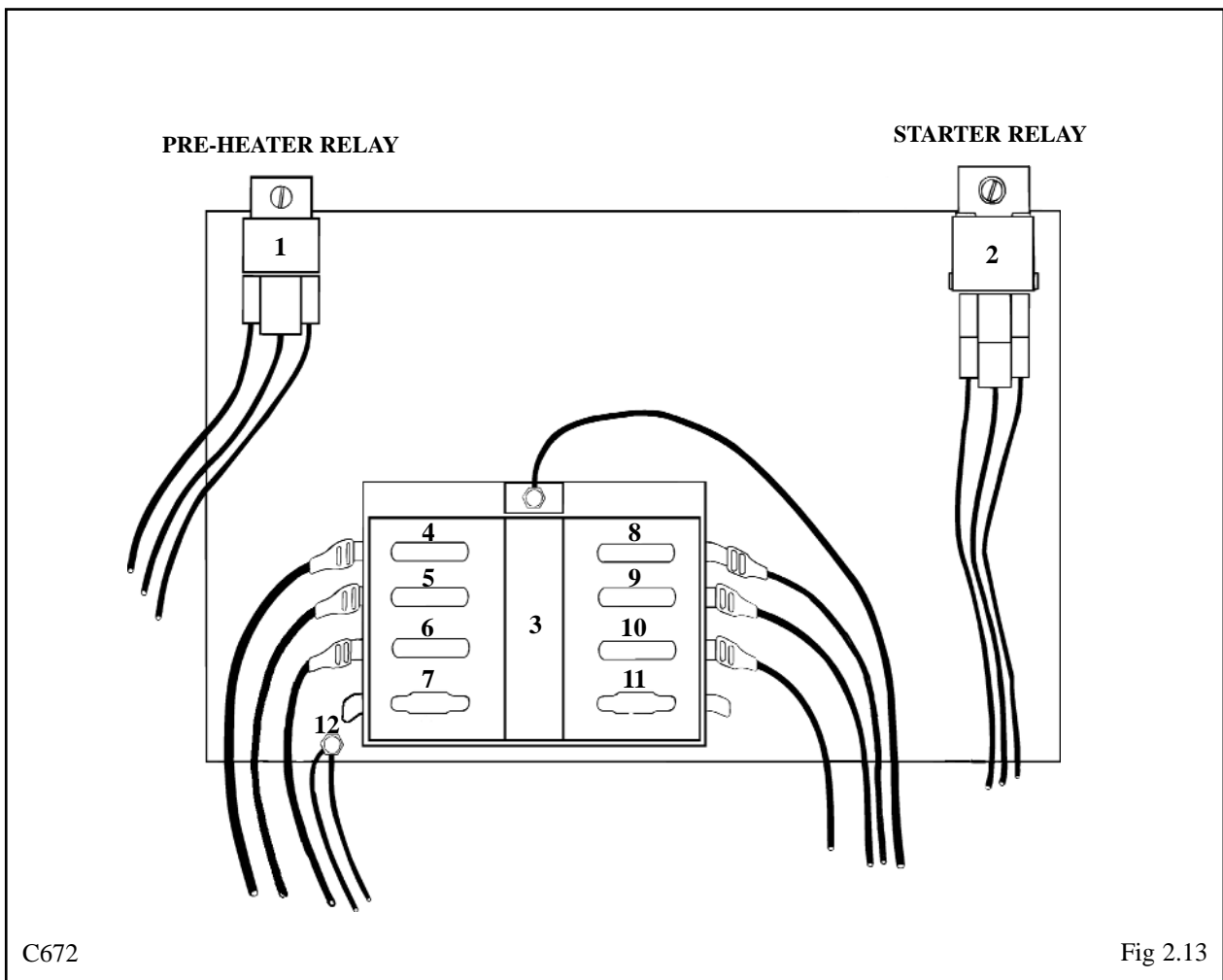

C672

Fig 2.13

2. CONTROLS

2.14 TWO SPEED CONTROL (NOT AVAILABLE ON ALL MODELS)

A switch located on the LH steering control lever (Fig. 2.14A) is used to alternately activate the loader's Two-Speed function. Pressing and releasing the switch will activate the Hi-speed function. Pressing and releasing the switch a second time will return the loader to the Low-speed function.

When the loader ignition is turned to the "OFF" position, the Two-Speed control returns to the Low-speed function.

An indicator panel is mounted on the LH ROPS post (Fig. 2.14B) to show the operator which function is activated at any given time. For proper loader operation, always select the loader speed function which is best suitable for the existing work environment.

NOTE: Always drive the loader at speeds compatible with safety, especially when operating over rough ground, unfamiliar terrain, when crossing ditches or when turning.

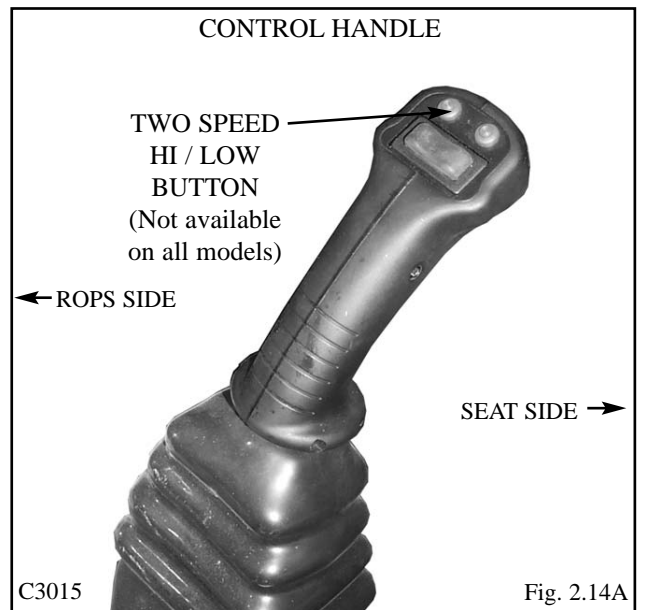

3. OPERATION

3. OPERATION

- 3.1 Starting Instructions
 - 1. Pre-Starting Inspection
 - 2. Starting Procedure
 - 3. Shut-Off Procedure
- 3.2 Operating Procedures
- 3.3 Filling From a Pile
- 3.4 Digging With a Bucket
- 3.5 Leveling and Backfilling
- 3.6 Auxiliary Hydraulics
- 3.7 Lifting
- 3.8 Towing
- 3.9 Securing and Transporting
- 3.10 Lowering Lift Arms
- 3.11 Accumulator

3. OPERATION

3.1 STARTING INSTRUCTIONS

1. Pre-Starting Inspection

Before starting the loader complete the following inspection:

- (1) Check the hydraulic oil level, engine oil level, engine coolant level and fuel supply.
- (2) Check for fuel, oil and hydraulic leaks.
- (3) Check lights, battery level and cables.
- (4) Check tire pressure:
12.00 x 16.5 40 - 45 PSI (276 - 310 kPa)
- (5) Check wheel nut torque 100 - 110 ft. lbs. (136- 149 Nm).
- (6) Lubricate all grease fittings.
- (7) Check the condition and operation of all safety decals and equipment – Ensure all shields and safety screens are in place. If necessary repair or replace before starting.

For complete daily servicing refer to section 4. 3.



2. Starting Procedure – Diesel

1. Ensure the seat bar is in the UP position, the steering controls are centered and the foot pedals are locked.
2. Adjust and fasten the seat belt securely around you.
3. Place the throttle control in idle position.
4. Turn the ignition key counter clockwise to activate the glow plugs. Hold approximately 15 seconds. Both the alternator and engine oil pressure warning lights should be on.
5. Turn the key clockwise to start position to engage the starter. Do not crank the starter for more than 15 seconds. If the engine fails to start turn the key counter clockwise and pre-heat again.
6. When the engine has started the engine oil pressure and alternator warning lights should go out. If they don't, shut - off the engine immediately and determine cause.
7. Allow the engine to warm up for five minutes before operating. When ready to operate, lower the seat bar and advance the throttle to full on position.

IMPORTANT

This engine is equipped with glow plugs. Do not use ether or any high energy fuels to assist starting.

WARNING

To avoid personal injury do not start the engine unless you are in the seat with the seat belt fastened around you, unless as specified in this manual or under specific service and backhoe operating procedures.

3. Shut-Off Procedure

- (1) Select level ground whenever possible. If you must park on a slope or incline, position the machine at right angles to the slope. Lower the attachment to the ground, engage the parking brake and block the wheels.
- (2) Lower the lift arms and ground the attachment.
- (3) Return auxiliary hydraulics to neutral or OFF position.
- (4) Return the throttle control to idle position. If the engine is hot allow it to idle until normal. At least 2 minutes.
- (5) Never enter or exit the loader when the engine is running.
- (6) Raise the seat bar to apply the park brake. Turn the ignition switch to the OFF position, remove the key, unfasten the seat belt, and ensure the hydraulic controls are locked by rocking them.

WARNING

To avoid personal injury, lower the lift arms, shut off the engine, raise the seat bar and cycle the controls to ensure they are locked. Then, unlatch the seat belt and exit the loader. Do not enter or exit with the engine running unless as specified in this manual or under specific service and backhoe operating procedures.

3. OPERATION

3.2 OPERATING PROCEDURES

1. When learning to use the loader operate at a slow rate.
2. Take advantage of the efficient operation of the loader. Keep the travel distance as short as possible. Keep the work area small so the cycle time is short.
3. Keep the work area as level as possible.
4. Decrease cycle time by “skid” turning (See Section 2.8) rather than a go backward-go forward turn.
5. Fill the bucket to rated capacity. Turning is easier with a full load than with a partial load. Keep the loaded bucket close to the ground when transporting.
6. Tilt the bucket as you raise the lift arms or drive up a slope. This will prevent material from falling off the back of the bucket.
7. Do not drive across a slope. Always go up or down a slope with the heavy end of the loader pointing up towards the top of the slope.

IMPORTANT

Always let the engine warm completely before you begin operation each day.

3.3 FILLING FROM A PILE

Push down on the toe of the lift arm pedal and lower the lift arms completely down (Fig. 3.3A). Push the toe of the bucket pedal and place the cutting edge of the bucket on the ground. For hand control units, move the L.H. control lever towards you and lower the lift arms completely down. Move the R.H. control lever away from you (Fig. 3.3A) and place the cutting edge of the bucket on the ground.

Drive the loader forward slowly. As the bucket begins to fill push on the heel of the bucket pedal to raise the front of the bucket (Fig. 3.3B) and push on the heel of the lift arm pedal to raise the lift arms. When the bucket is full back away from the pile. For hand control units, move the R.H. control lever towards you to raise the front of the bucket, and move the L.H. control lever away from you to raise the lift arms (Fig. 3.3B). When the bucket is full back away from the pile.

To dump the bucket (Fig. 3.3C) push down on the heel of the lift arm pedal to raise the lift arms. Push down on the toe of the bucket pedal small amounts as the lift arms are raising to stop material from falling off the back of the bucket. When the bucket is at the correct height for dumping, push on the toe of the bucket pedal to empty the bucket.

For hand control units, move the L.H. control lever away from you (Fig. 3.3C) to raise the lift arms. Move the R.H. control lever away from you in small amounts as the lift arms are raising to stop material from falling from the back of the bucket. When the bucket is at the correct height for dumping, move the R.H. lever away from you to empty the bucket.

* Hand controls not available on all machines.

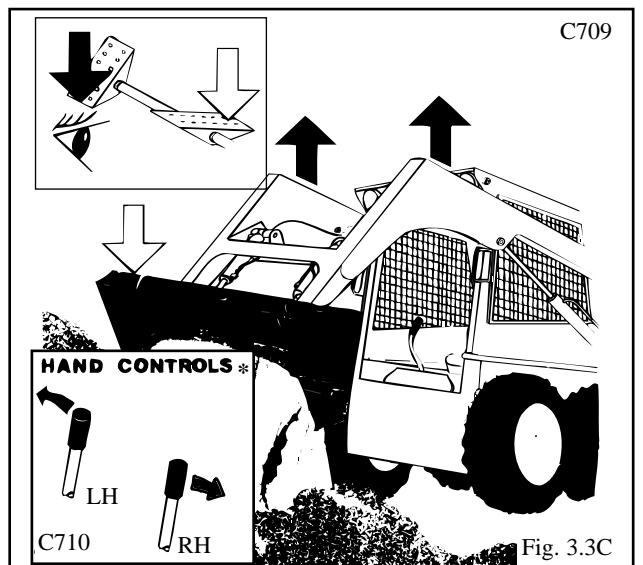
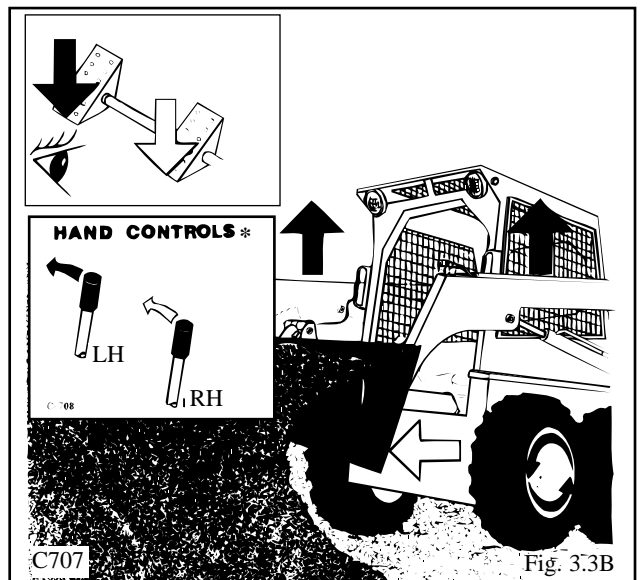
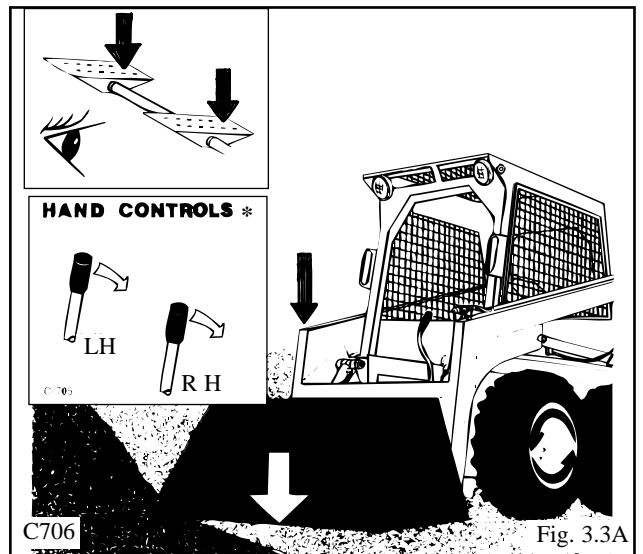

3. OPERATION

3.4 DIGGING WITH A BUCKET

Push on the toe of the lift arm pedal and lower the lift arms completely down. Push on the toe of the bucket pedal and place the cutting edge of the bucket on the ground (Fig. 3.4D). Drive the loader forward at a slow rate and continue to tilt the bucket down until it enters the ground.

Push down on the heel of the bucket pedal (Fig. 3.4E) to increase traction and keep an even digging depth.

Continue to drive forward until the bucket is full. When digging in hard ground, it is easier to raise and lower the bucket cutting edge with the tilt pedal while slowly driving forward. When the bucket is full, push down on the heel of the bucket pedal (Fig. 3.4F) to raise the tip of the bucket.

For hand control units, move the L.H. control lever towards you to lower the lift arms completely down. Move the R.H. control lever away from you and place the cutting edge of the bucket on the ground (Fig. 3.4D). Drive the loader forward at a slow rate and continue to tilt the bucket down until it enters the ground. Move the R.H. control lever towards you (Fig. 3.4E) to increase traction and keep an even digging depth. Continue to drive forward until the bucket is full. When the bucket is full, move the R.H. control lever towards you (Fig. 3.4F) to raise the tip of the bucket.

*** Hand controls not available on all machines.**

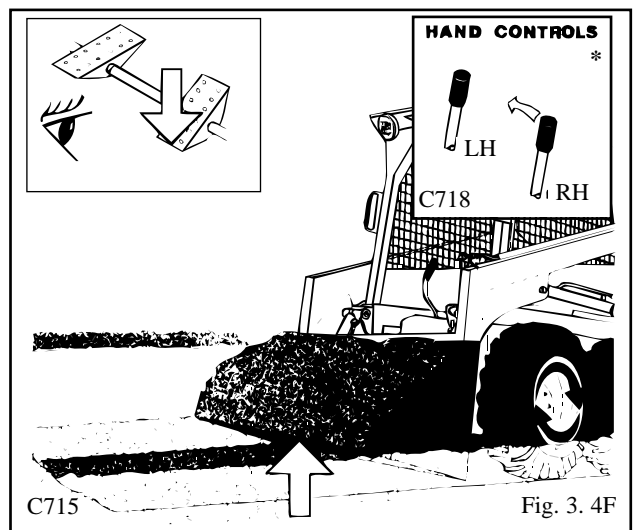
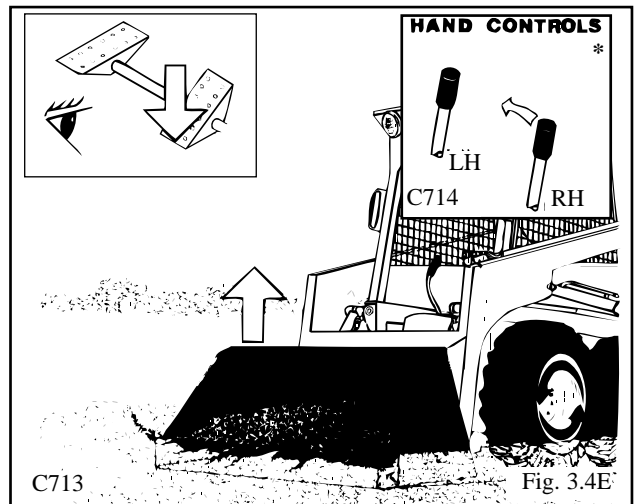
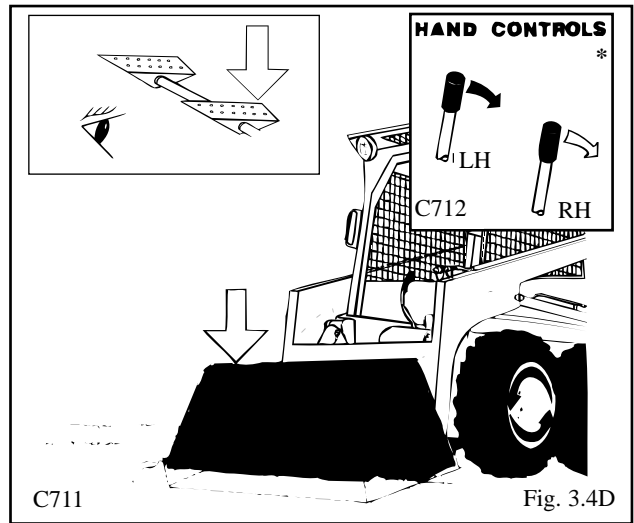

| | |
|----------------|---|
| WARNING | <p>To prevent personal injury, ensure that the bucket with the proper rated capacity is being used for the job you are doing.</p> |
|----------------|---|

| | |
|----------------|---|
| WARNING | <p>To avoid personal injury: When starting or operating loader in an enclosed area make sure there is enough ventilation. Exhaust fumes can kill.</p> |
|----------------|---|

| | |
|----------------|--|
| WARNING | <p>To prevent personal injury always carry the load low.</p> |
|----------------|--|

3. OPERATION

3.5 LEVELING AND BACKFILLING

Spread dirt on uneven ground by pushing on the heel of the lift arm pedal (Fig. 3.5G) to raise the lift arms and push on the toe of the bucket pedal to tilt the bucket down as you drive forward.

For hand control units, spread dirt on uneven ground by moving the L.H. control lever away from you (Fig. 3.5G). To raise the lift arms and move the right hand control lever away from you to tilt the bucket down as you drive forward.

To level the ground; raise the lift arms and tilt the bucket down by pressing on the toe of the bucket pedal. (See Fig. 3.5H) Push firmly on the toe of the lift arm pedal to lock the lift arms in the float position. The weight of the lift arms and bucket will hold the bucket on the ground. Drive backward to level material.

To level the ground with a hand control unit, raise the lift arms and tilt the bucket down by moving the R.H. lever away from you. Move the L.H. control lever all of the way towards you (Fig. 3.5H) to place the lift arms in the float position. The weight of the lift arms and the bucket will hold the bucket on the ground. Drive backwards to level material.

To fill a hole (Fig. 3.5I) drive the loader slowly with the bucket low, up to the hole. As the bucket passes the edge of the hole, push on the toe of the bucket pedal to dump the bucket. When necessary raise the lift arms to empty the bucket.

On hand control units, as the bucket passes the edge of the hole, move the R.H. control lever away from you to dump the bucket. When necessary, raise the lift arms to empty the bucket.

* Hand controls not available on all machines.

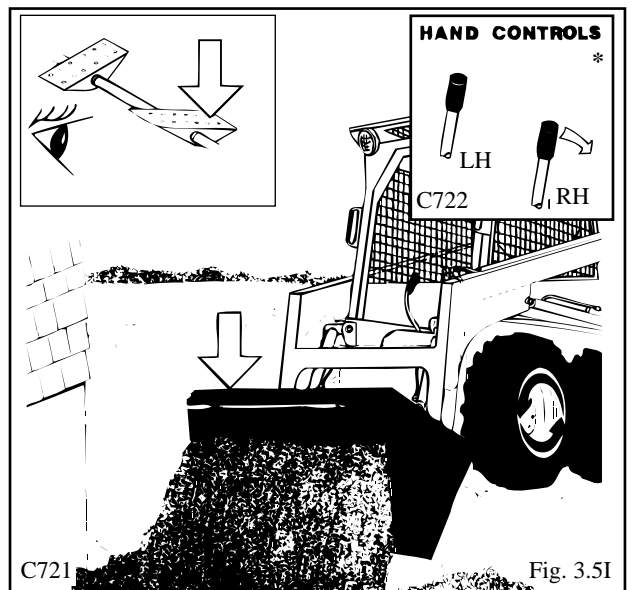
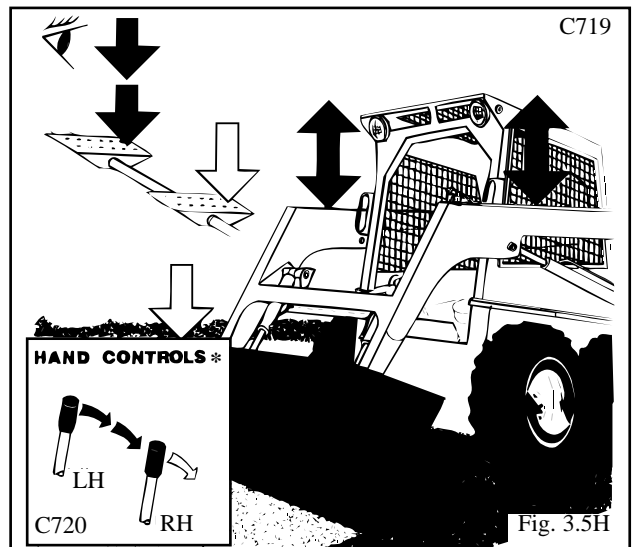
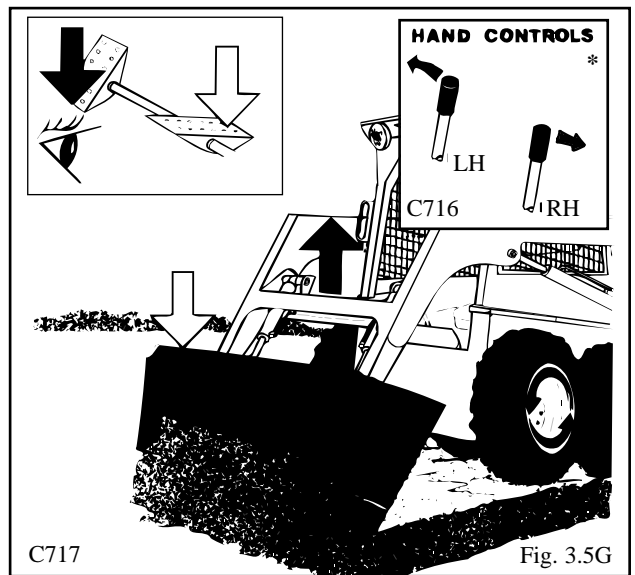

3. OPERATION

3.6 AUXILIARY HYDRAULICS

To operate an attachment such as a grapple fork the Left Hand Control Lever will be used. Push right of neutral on the Auxiliary Hydraulic Control Switch to open the grapple (See Fig. 3.6J).

To close the grapple (Fig. 3.6K), push left of neutral on the Auxiliary Hydraulic Control Switch, or push down on the toe of the auxiliary pedal if so equipped. The lift arm and the bucket pedals can be used to raise and tilt the grapple as with a bucket.

To operate an attachment which requires a constant flow of oil such as a backhoe or sweeper, a toggle switch on the L.H. instrument panel (Fig. 3.6L) should be placed in the ON position.

When the auxiliary circuit is not in use switch to the OFF position otherwise starting the loader may be difficult or impossible and damage to the starter may occur.

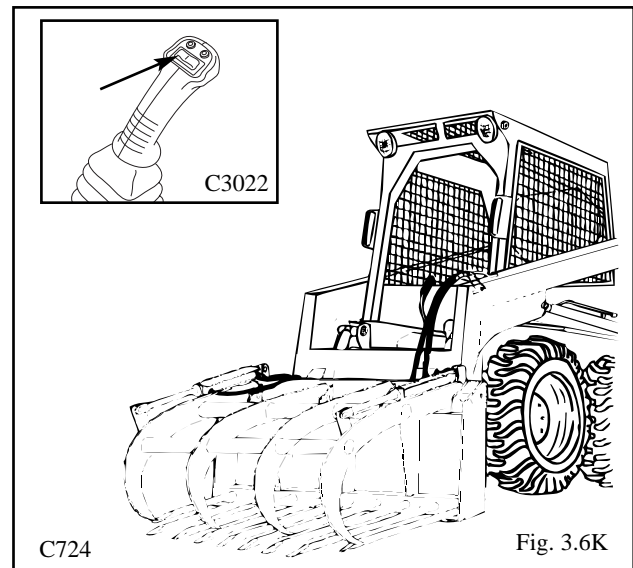
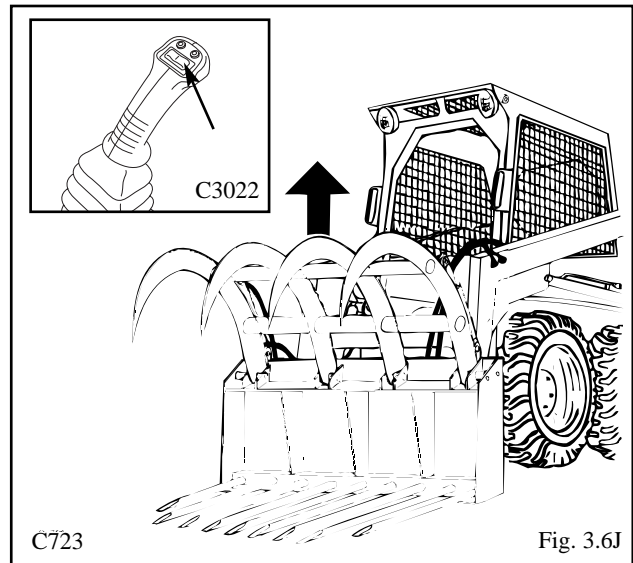

| | |
|------------------|---|
| IMPORTANT | <p>Return the auxiliary control to neutral when not in use otherwise starting may be impossible and damage to the starter may occur.</p> |
|------------------|---|

| | |
|--|---|
|  WARNING | <p>To avoid personal injury, lower the lift arms, shut off the engine, raise the seat bar and cycle the controls to ensure they are locked. Then, unlatch the seat belt and exit the loader. Do not enter or exit with the engine running unless as specified in this manual or under specific service and backhoe operating procedures.</p> |
|--|---|

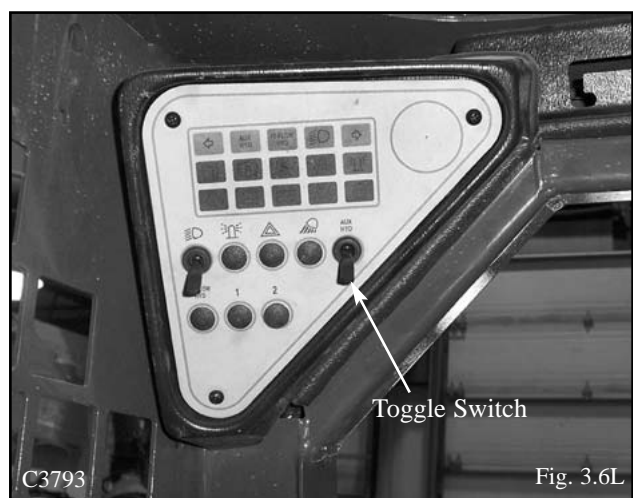

3. OPERATION

3.7 LIFTING

The loader may be equipped with features to use in lifting (for example by crane onto a flatbed trailer or a flat car), for securing, and for extraction (from mud or snow). To facilitate this requires the optional lifting lugs.

To lift using a crane, first follow the shut - off procedure in section 3.1-3.

Once this is done, attach properly rated cables, chains or straps to the lift points (See Fig. 3.7). To prevent marking the operator guard or chafing of the lifting cable, a lifting frame should be used.

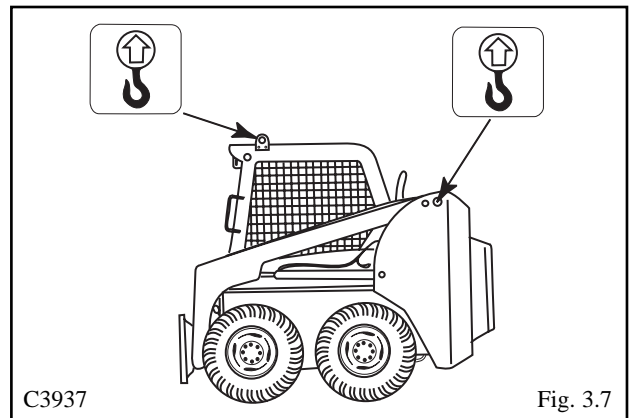

3.8 TOWING

1. When winching or towing a stuck loader from the rear, always lower the lift arms until the attachment is resting on the ground and then follow the shut-off procedure (See Section 3.1-3).
2. When winching or towing a stuck loader from the front, lower the attachment so that the front attachment points are accessible and have an assistant block the attachment, then follow the shut-off procedure (See Section 3.1-3).
3. Attach a properly rated chain, cable or towing strap to the towing points provided (Fig. 3.8A).
4. Deactivate the brake system for towing. To release the park brake, turn the release button on the brake valve counter clockwise. Pressurize the brake release quick coupler to 218 PSI (15 Bar). This will release the motor brakes for towing. See maintenance section 4.7-6 for details.
5. Open the pump bypass valve (manually operated). To accomplish oil bypass, turn the bypass valve nut (Fig. 3.8B) counter-clockwise two (2) revolutions. (DO NOT open the valve past two (2) turns.) When open, the valve connects both sides of the pump/motor circuit and allows the motor to turn for towing short distances at low speeds without running the engine. The valve closing torque is 7-10 ft. lbs. (9.5-14 Nm).
 - * Damage to the unit may result from over-torquing the bypass valve.
6. The attachment point on the towing or winching equipment should be kept as low as possible and in as direct a line as possible with the stuck loader. A steep tow line angle or side pull could result in upsetting the stuck loader.

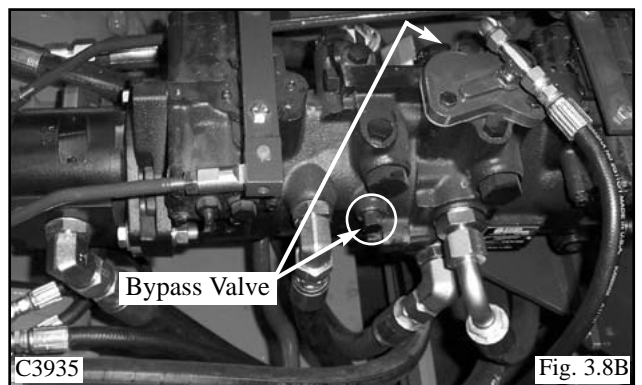
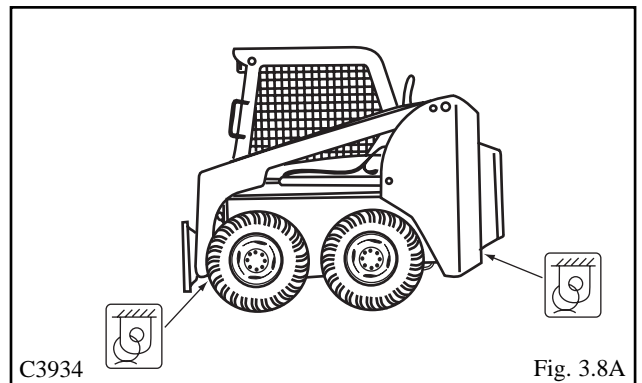

IMPORTANT

Never install tie down chains across the bucket cylinders. Damage to the cylinders may occur.

WARNING

To avoid personal injury, lower the lift arms, shut off the engine, raise the seat bar and cycle the controls to ensure they are locked. Then, unlatch the seat belt and exit the loader. Do not enter or exit with the engine running unless as specified in this manual or under specific service and backhoe operating procedures.

3. OPERATION

3.9 SECURING AND TRANSPORTING

There are three tie down points provided for securing the skid steer while transporting. One at the lower front and two at the rear (Fig. 3.9).

Be sure the trailer and/or truck is of adequate size and capacity to safely transport your skid steer.

Measure the clearance height of the machine and trailer or truck, and post it in the cab of the truck.

Before loading the skid steer make sure the ramps and parking surface are free of all oil, grease, ice, etc. and of sufficient strength to support the load.

Know the local rules and regulations, and make sure your truck and trailer is equipped with the correct safety equipment.

When loading a skid steer with an attachment, always load the heavy end first.

Once the skid steer has been loaded, lower the attachment to the floor, stop the engine and engage the park brake.

Install chains at the front and rear tie down locations, and securely attach to the transport vehicle.

NOTE: Minimum 3/8 in. grade 40 chain is required

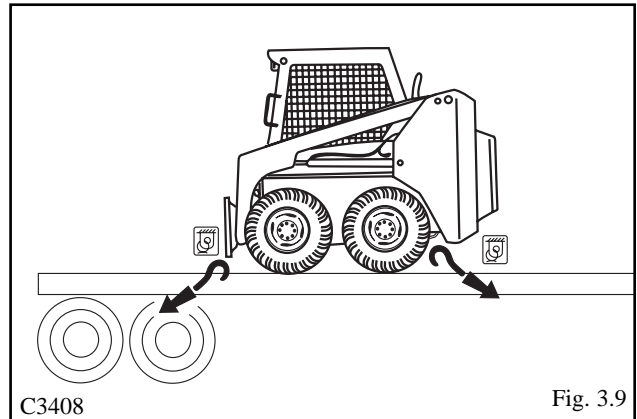

IMPORTANT

When moving your skid steer on or off a transport vehicle, drive slowly and keep the machine centered.

WARNING

Ramps must be of sufficient strength to support the weight of your skid steer. Wooden ramps can break and cause personal injury.

SAFE SHUTDOWN PROCEDURES

- Stop machine
- Lower the bucket and other attachments flat on the ground
- Position controls in neutral
- Raise operator seat bar to engage parking brake
- Idle engine for short cool-down period
- Stop engine
- Cycle all controls to ensure they are locked in neutral
- Unbuckle seat belt
- Remove ignition key and lock covers and closures

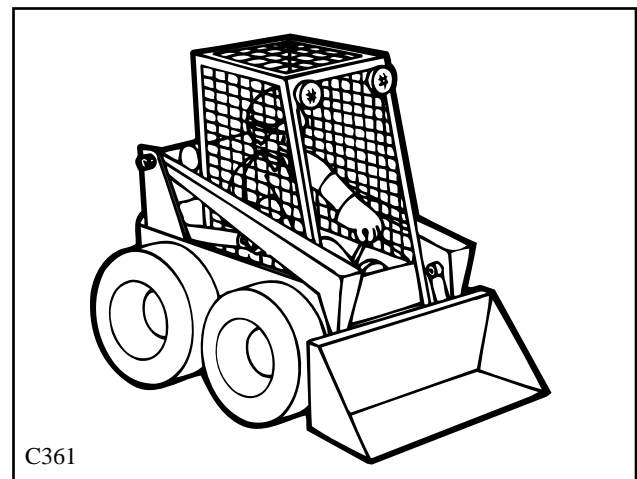

WARNING

To avoid personal injury, lower the lift arms, shut off the engine, raise the seat bar and cycle the controls to ensure they are locked. Then, unlatch the seat belt and exit the loader. Do not enter or exit with the engine running unless as specified in this manual or under specific service and backhoe operating procedures.

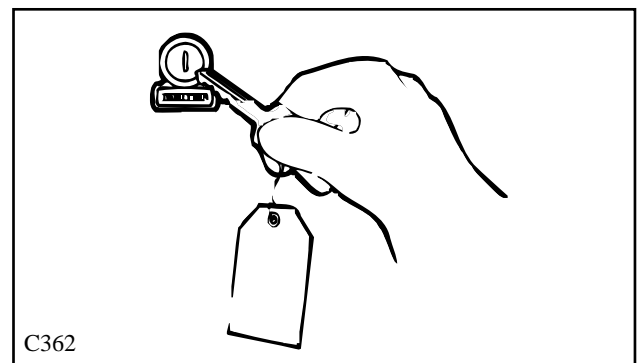

3. OPERATION

3.10 LOWERING LIFT ARMS (ENGINE OFF)

In the event that you should have an electrical failure which renders your skid steer inoperable with the lift arms up, the following procedures would apply.



1. Lift Arm Height Is Sufficient To Engage Lift Arm Support Pins

Engage lift arm support pins. (Fig. 3.10A) Raise seat bar and cycle all controls to ensure they are locked. Exit loader and open rear door. Locate the control valve on the RH side of the machine. Unplug the electrical wire and remove the knurled nut holding the solenoid on the spool lock. Remove the solenoid, then remove the lock pin and spring assembly (Fig. 3.10C). Once the lock pin and spring are removed, the lift arm spool is free to travel. Enter the machine, being careful not to cycle the foot pedals or the control levers as the locking system has been disabled. Once in the operator seat, dis-engage lift arm support pins. Move the lift arm pedal or control lever to lower the lift arms to the ground.

2. Lift Arm Height Is Not Sufficient To Engage Lift Arm Support Pins

DO NOT EXIT FROM FRONT OF LOADER WITHOUT LIFT-ARMS ON GROUND OR SUPPORTED BY ACCEPTABLE MEANS!

Raise seat bar and cycle all controls to ensure they are locked. If help is readily available, have someone place a suitable support under the lift arms (e.g. 4" x 4" Lumber) or a piece of angle iron between lift cylinder end cap and lift cylinder rod mount.

Then exit loader using extreme caution. If help is not available, the operator must exit the loader from the rear window and perform the proper lift arm supporting (as described previously). Once this is completed, open rear door. Locate the control valve on the RH side of the machine (Fig. 3.10B). Unplug the electrical wire and remove the knurled nut holding the solenoid on the spool lock. Remove the solenoid, then remove the lock pin and spring assembly (Fig. 3.10C). Once the lock pin and spring are removed, the lift arm spool is free to travel.

Ensure assistance is available, then the operator can enter the machine, being careful not to cycle the foot pedals or the control levers as the locking system has been disabled. Once in the operator seat, have the assistant remove the lift arm support devices. The operator can then move the lift arm pedal or control lever to lower the lift arms to the ground.

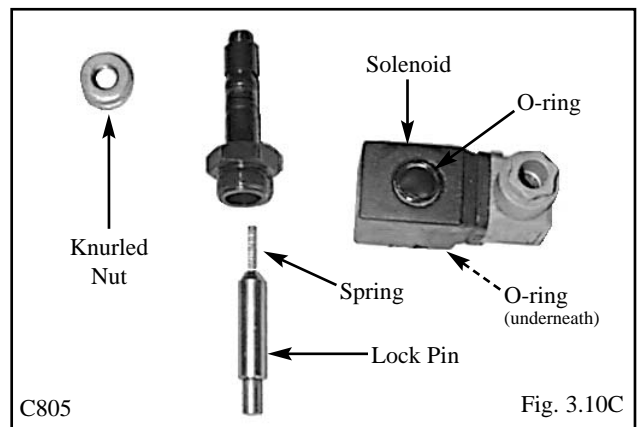
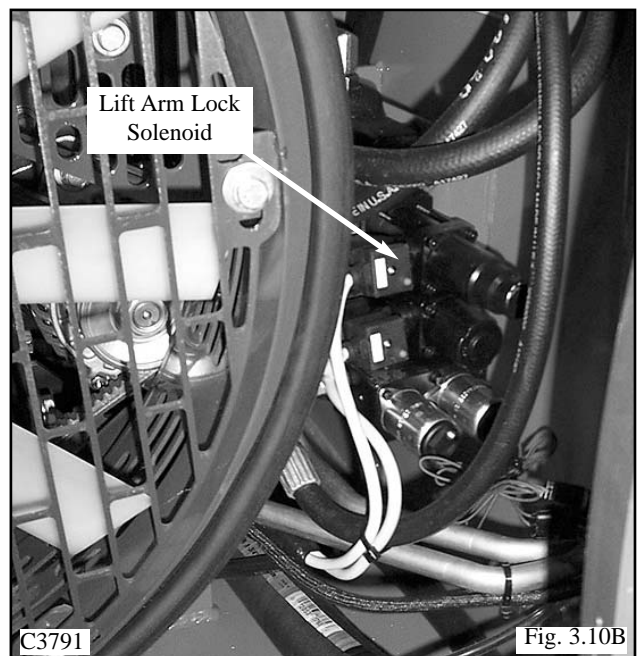
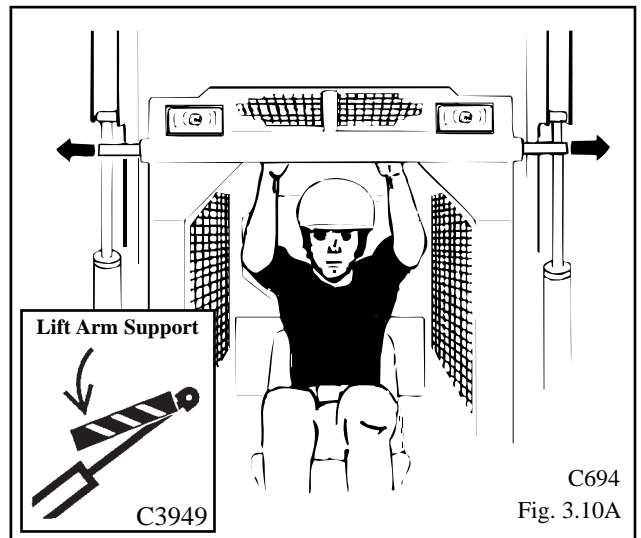

3. OPERATION

3.11 ACCUMULATOR

The accumulator (Fig. 3.11A) stores system pressure until it is required to activate the electric auxiliary. The key must be placed in the "ON" position to operate the electric auxiliary (engine not running).

The electric auxiliary and stored system pressure can be used to activate the spools. This decreases the hydraulic pressure from the male / female couplers located on the lift arms. This is accomplished by cycling the momentary switch on the LH control a couple of times (see Fig. 3.11B).

Once this pressure is decreased the operator can remove / replace the quick attach accessories easily.

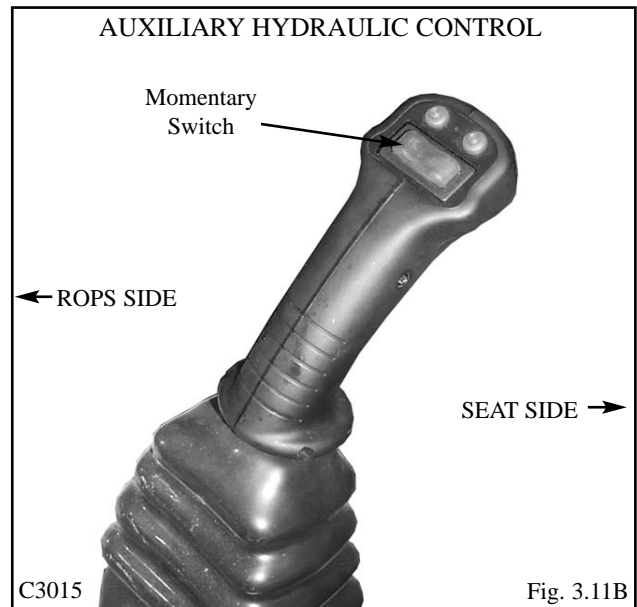
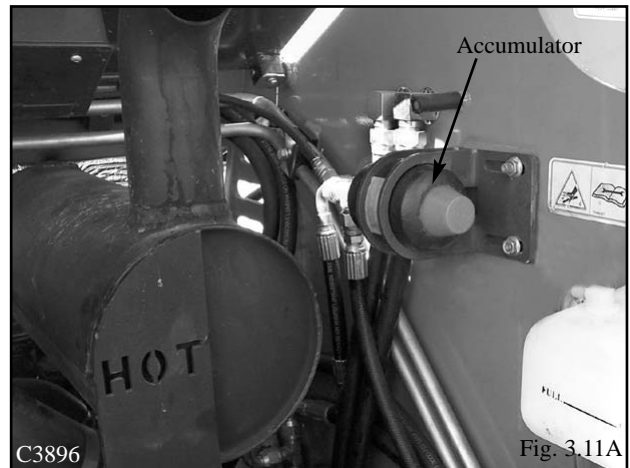

4. MAINTENANCE

4. MAINTENANCE

- 4. 1 Preventative Maintenance Service Schedule
- 4. 2 Service Access
 - 1. Lift Arm Support
 - 2. Seat Removal
 - 3. Battery Access
 - 4. Engine Compartment
- 4. 3 Daily Service Check
 - 1. Hydraulic Oil Level
 - 2. Air Cleaner
 - 3. Tires and Wheel Nuts
 - 4. Safety Equipment
 - 5. Decals
 - 6. Lubrication
 - 7. Engine Oil Level
 - 8. Radiator / Oil Cooler Service
- 4. 4 50 Hour Service Check
 - 1. Engine
 - 2. Hydraulic / Hydrostatic
 - 3. Final Drive
 - 4. Controls and Safety Equipment
 - 5. Electrical
 - 6. Grease / Lubrication
 - 7. General
- 4. 5 150 Hour Service Check
- 4. 6 Final Drive Maintenance
 - 1. Oil Level Check
 - 2. Adding Oil
 - 3. Drive Chain, Axle and Sprocket Inspection
- 4. 7 Hydraulic / Hydrostatic System Maintenance
 - 1. Oil Level Check
 - 2. Adding Oil
 - 3. Hydraulic Filter Replacement
 - 4. Draining System Fluid
 - 5. Oil Cooler and Cooling Fan
 - 6. Brake Service Override
- 4. 8 Engine Maintenance
 - 1. Engine Specifications
 - 2. Oil Level Check
 - 3. Engine Oil and Filter Replacement
 - 4. V-Belt Tension
 - 5. Adding Fuel
 - 6. Fuel Filter Replacement
 - 7. Bleeding the Fuel System
- 4. 9 Air Cleaner Maintenance
 - 1. Daily Maintenance
 - 2. Servicing Cleaner Element
- 4. 10 Engine Cooling System
- 4. 11 Electrical System
 - 1. Battery Maintenance and Boosting
 - 2. Electrical Schematic - ROPS
 - 3. Electrical Schematic - Engine
- 4. 12 Tire Maintenance
 - 1. Tire Inflation and Service
 - 2. Tire Rotation
- 4. 13 Troubleshooting
 - 1. Hydraulic System
 - 2. Hydrostatic Drive
 - 3. Final Drive Transmission
 - 4. Control Levers
 - 5. Electrical
 - 6. Engine
- 4. 14 Hydraulic / Hydrostatic Circuit
- 4.15 Special Tools

4. MAINTENANCE

4.1 PREVENTIVE MAINTENANCE SERVICE SCHEDULE

| ITEM | SERVICE REQUIRED | 8 HOURS | 50 HOURS | 150 HOURS | 300 HOURS | 1000 HOURS |
|--|---|---------|----------|-----------|-----------|------------|
| Engine Oil | Check level and add if necessary. Use 5W40 API Classification CF oil. | | | | | |
| Hydraulic Oil | Check level and add if necessary. Use 10W30 API Classification SJ (-20°C to 35°C) or 20W50 API Classification SJ (-10°C to 45°C) oil. | | | | | |
| Radiator & Oil Cooler | Check level and add if necessary. Fill with 50% mixture of ethylene glycol and water. Check cooling fins for dirt. (See Section 4.4) | | | | | |
| Air Cleaner | Empty dust cap. Check condition indicator and replace element as required. | | | | | |
| Tires and Wheel Nuts | Check for low pressure or tire damage, refer to Section 5.1 for more information. Check wheel nut torque 100-110 ft. lbs. (136-149 Nm). | | | | | |
| Safety Equipment | Check all safety equipment for proper operation and condition. Seat belt, seat bar, control locks, lift arm supports, quick-tach locks, parking brake, safety treads, front shield and cab side screens. If necessary lubricate foot pedal and steering control linkages, springs and shafts with a silicone based lubricant. If necessary repair or replace. | | | | | |
| Decals | Check for damaged safety or instruction decals (See Section 5.3). If necessary replace. | | | | | |
| Lubrication | Grease all hinge pin fittings and pivot bearings until excess shows. | | | | | |
| Hydraulic Oil Filter | Replace hydraulic oil filter element. Initial change only. | | | | | |
| Safety System Linkages and Springs | Check and if necessary adjust. Lubricate shaft and linkage with a silicone based lubricant. | | | | | |
| 50 Hour Service | Perform complete 50 hour service (See Section 4.4). | | | | | |
| Engine Oil | Replace engine oil. Use API Classification CF oil. (See Section 4.8-3). Initial change only. | | | | | |
| Engine Oil Filter | Replace engine oil filter. Initial change only. | | | | | |
| Final Drive | Check chain and sprocket condition. Check every 150 hours. | | | | | |
| Hydraulic Oil Filter(s) | Replace hydraulic oil filter element (See 4.7-3). | | | | | |
| Preventative Maintenance Service Check | It is recommended as a preventative maintenance procedure that the 50 hour service be repeated every 150 hours. (See Section 4.5) | | | | | |
| Engine Oil | Replace engine oil. Use API Classification CF oil. See 4.8-3. Replace every 150 hours. | | | | | |
| Engine Oil Filter | Replace engine oil filter. See 4.8-3. Replace every 300 hours. | | | | | |

4. MAINTENANCE

| ITEM | SERVICE REQUIRED | 50 HOURS | 150 HOURS | 300 HOURS | 800 HOURS | 1000 HOURS |
|------------------------|---|----------|-----------|-----------|-----------|------------|
| Engine Fuel Filter | Replace engine fuel filter. (See Section 4.8-6). | | | | | |
| Engine Valve Clearance | Adjust (See Hyundai Dealer). | | | | | |
| Final Drive | Change final drive lubricating oil. Use 10W30 API Classification SJ oil. | | | | | |
| Hydraulic reservoir | Remove and replace the 100 micron suction element in the oil reservoir. Change hydraulic oil. Replace with 10W30 API Classification SJ oil. | | | | | |
| Engine Cooling System | Drain, flush and refill. Use 50% mixture of ethylene glycol and water. | | | | | |



WARNING

WARNING: Escaping hydraulic fluid under pressure can penetrate the skin causing serious injury.

- **DO NOT** use your hand to check for leaks. Use a piece of cardboard or paper to search for leaks.
 - Stop engine and relieve pressure before connecting or disconnecting lines.
 - Tighten all connections before starting engine or pressurizing lines.

If any fluid is injected into the skin, obtain medical attention immediately.



WARNING

To avoid personal injury service repairs must be performed by an authorized Hyundai dealer.

4. MAINTENANCE

4.2 SERVICE ACCESS

1. Lift Arm Support

For safety while performing regular service or maintenance work, the loader is equipped with lift arm support pins. The lift arm support pins, when extended, prevent the lift arms from dropping if hydraulic pressure is relieved or the hydraulic controls are accidentally cycled.

To operate the lift arm support, first remove any bucket or attachment from the quick-tach and raise the lift arms to full height. Push the lift arm support handle (Fig. 4.2A) out toward lift arms to extend the lift arm supports (Fig. 4.2B). Slowly lower the lift arms down on to the pins. To retract the lift arm supports, lift the lift arms off of the pins before retracting pins.

IMPORTANT

Fully retract lift support pins before raising or lowering lift arms.

WARNING

To avoid personal injury: Do not leave lift arms up unless the lift arm supports are engaged.

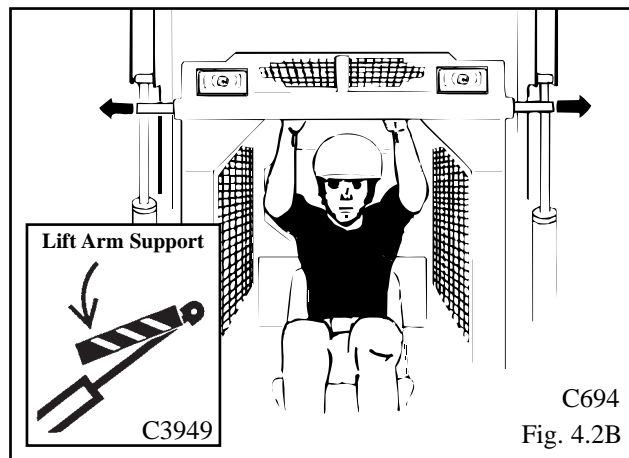
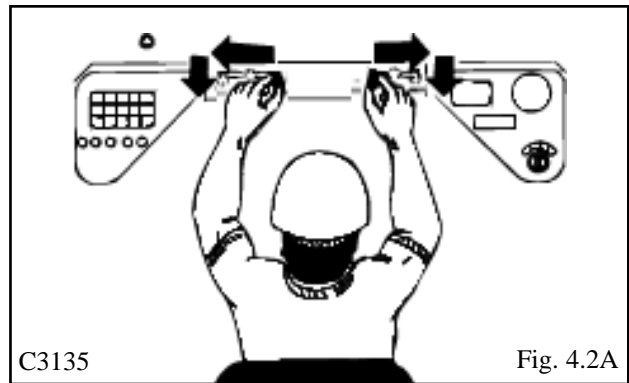

2. Seat Removal

The seat assembly can be removed to provide access to the controls, hydraulic and hydrostatic components. To remove the seat assembly, remove the fasteners located at the front of the seat. **DISCONNECT ELECTRICAL PLUG!** Lift the seat assembly out of the machine. When installing the seat, be sure the seat plate is locked in place at the rear (Fig. 4.2C).

3. Battery Access

The batteries are located in a compartment found behind the operators seat (Fig. 4.2D). Remove the seat and remove the bolt holding the battery cover in place. The battery compartment is hinged with a prop rod to hold open.

See Section 4.11 for Boosting Procedures.

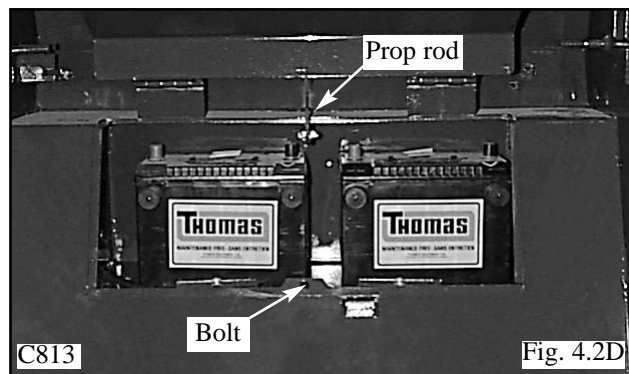
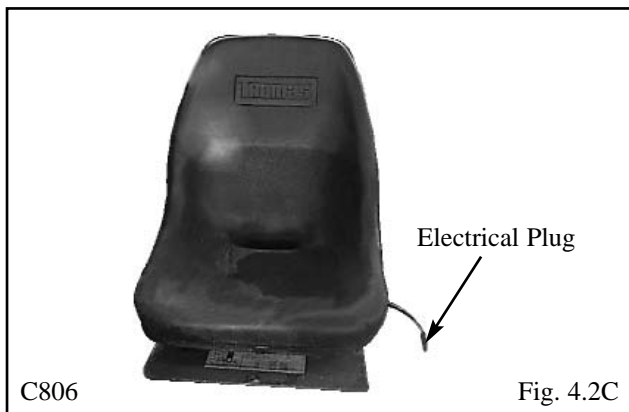

4. MAINTENANCE

4. Engine Compartment

The engine compartment is completely enclosed for component protection and lockable to discourage vandalism. For servicing, the rear door swings open and the engine cover hinges up (Fig. 4.2F).

To open, reach through the opening in the rear door (Fig. 4.2F), and pull outward releasing the door latch. Then, open the radiator/oil cooler by removing the pins located on the side of the radiator (Fig. 4.2G). Always remember to lower the engine cover before closing the rear door.

IMPORTANT

Keep the rear door and radiator closed and latched except for servicing.

4.3 DAILY SERVICE CHECK

1. Hydraulic Oil Level

Check the oil level with the machine on a level surface with the lift arms down and the attachment grounded. Open the rear door and check the oil level sight glass (Fig. 4.3A). If oil is apparent the oil level is satisfactory.

If necessary to add oil, remove the reservoir cap located at the top of the oil reservoir and add oil until oil appears in the oil level sight glass.

Use a good quality 10W30 oil which meets the API classification SJ only.

WARNING

To avoid personal injury: Stop, Cool and Clean the engine of flammable materials before servicing. Never service or adjust machine with engine running.

2. Air Cleaner

The loader is equipped with an air cleaner restriction warning lamp. Should this lamp illuminate, shut off the engine and determine cause. Possibly a plugged air filter. Figure 4.3B shows the air cleaner.

Check that all hose clamps are tight and the hose is undamaged. Check the vacuator valve for damage (Fig. 4.3B).

See Section 4.9 for Air Cleaner Maintenance.

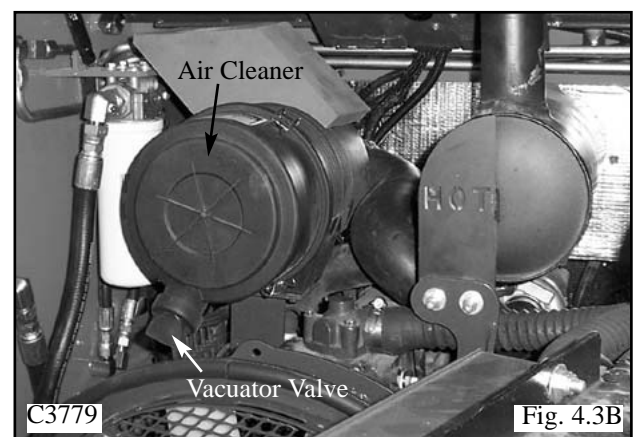
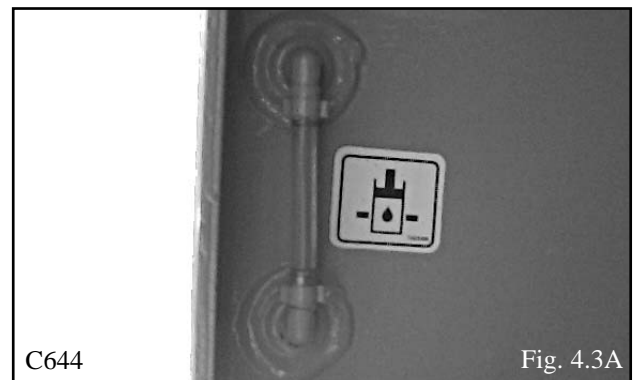
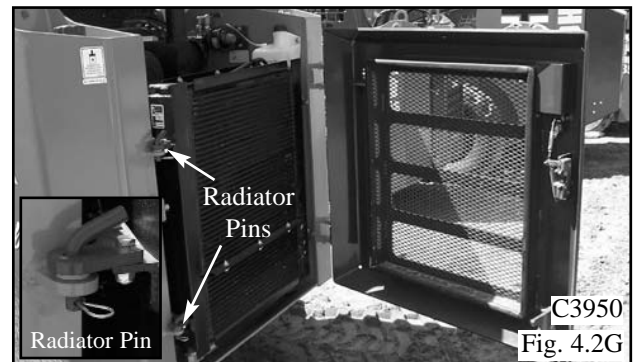
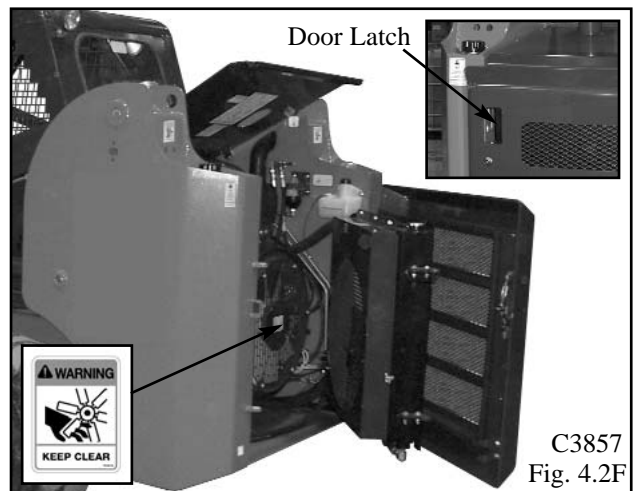

4. MAINTENANCE

3. Tires and Wheel Nuts

Inspect tires for wear or damage. Check and inflate tires to correct pressure:

12.00 x 16.540 - 45 PSI (276 - 310 kPa)

Tires can be inflated to 50 PSI (345 kPa) when operating on hard, flat surfaces.

To prevent shearing of the wheel studs and rim damage check wheel nuts for proper torque 100 -110 lbs. ft. (136 - 149 Nm) daily (Fig. 4.3C). After changing a rim, Check wheel nuts hourly, until the reading stabilizes.

4. Safety Equipment

Check all safety equipment for proper operation and condition - seat belt, lift arm supports, seat bar, parking brake, quick tach lock, shields, safety treads and control locks. Lubricate all linkages, springs and pivot points with a silicone based lubricant. Repair or replace if necessary.

5. Decals

Check the condition of all safety and instruction decals. Replace any damaged or missing decals. Refer to Section 5.3 for decal description and locations.

6. Lubrication

There are sixteen (16) grease fittings located in the loader that require lubrication every eight hours. Lubricate with a good quality multi-purpose lithium based grease. Apply grease until excess shows. Refer to the service schedule for complete service details. (See Fig. 4.3D). The sixteen (16) lubrication points are:

- Rear Lift Arm Pivots (2)
- Lift Cylinder Bushings (4)
- Bucket Cylinder Bushings (4)
- Lift Arm Supports (2)
- Quick Tach Pivot and Lock Pins (4)

7. Engine Oil Level

Check the oil before engine start up. If the engine has been running let it cool for at least 5 minutes to allow the oil to drain back to the oil pan.

To check the oil level, check with the loader on level ground, open the rear door and remove the dipstick (Fig. 4.3E).

Keep the oil level between the full and low mark on the dipstick (Fig. 4.3F). Do not fill above the full mark. Use API Classification CF oil.

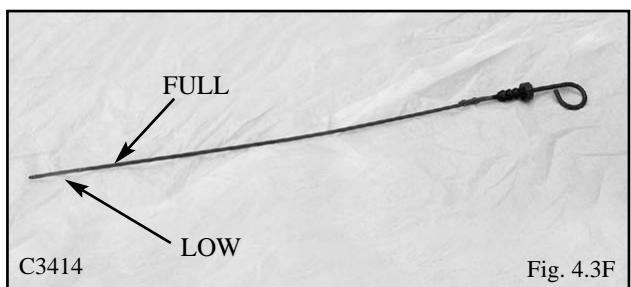
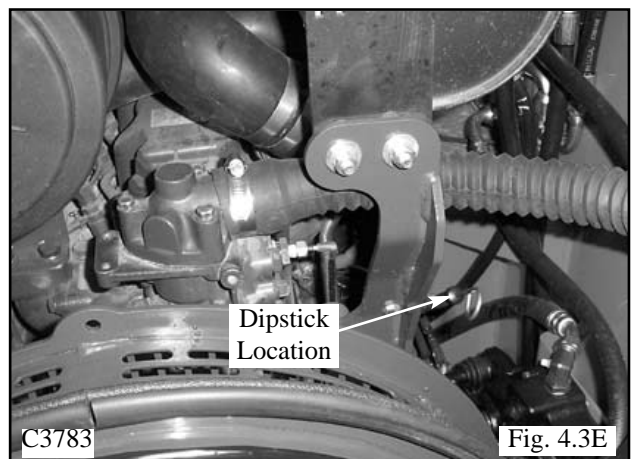
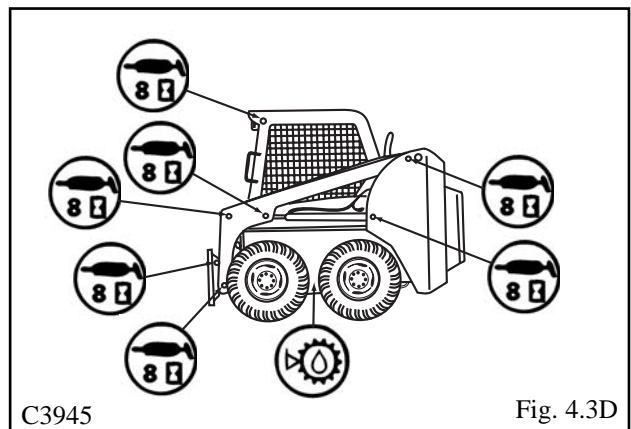
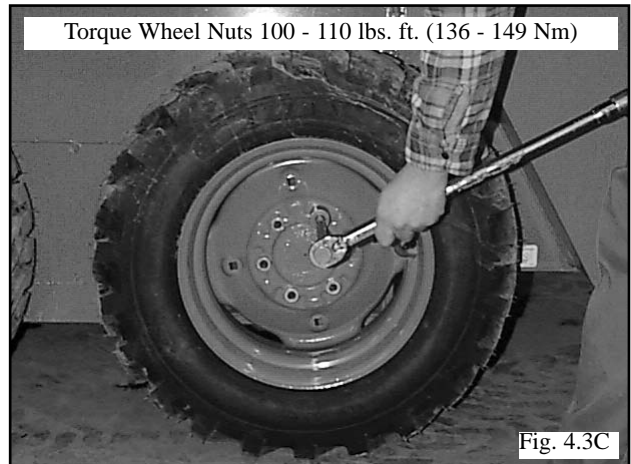

4. MAINTENANCE

8. Radiator / Oil Cooler Service

With the engine cool, check the coolant level in the overflow reservoir (Fig. 4.3G). Ensure the coolant level is at the Full-Cold mark on the reservoir by adding a 50% mixture of ethylene glycol and water if required.

The radiator and oil cooler fins must be kept free of debris otherwise overheating of the engine and hydraulic system will occur. Inspect the radiator cooling fins for damage or buildup of debris. Repair any damage and if necessary clean the radiator with compressed air to remove debris.

4.4 50 HOUR SERVICE CHECK

The following service check is to be performed by your dealer after the first 50 hours of operation.

1 Engine

1.1 Oil and Filter:

Change the engine oil and filter. Use only original replacement parts. Change the oil every 150 hours thereafter. Change the filter every 300 hours thereafter.

1.2 Radiator:

Check the coolant level. A dirt buildup on the radiator cooling fins can cause engine overheating. If necessary, clean the radiator with compressed air. Check the sealing ring on the plenum and radiator/cooler for proper sealing. Repair or replace if necessary.

1.3 V-Belt Tension and Condition:

Check v-belt for cuts or wear, if necessary replace. Check tension and adjust as shown in Section 4.8-4.

1.4 Fuel System for Leaks:

Make a visual inspection of fuel system for leaks and potential hazards such as fuel line(s) touching exhaust manifold, flywheel, etc. Replace fuel filter every 300 hours.

1.5 Air Intake and Cleaner System:

Visually inspect the air cleaner system and be sure all hose clamps are secure and no hoses are damaged.

1.6 Exhaust System:

Visually inspect the exhaust system and ensure all clamps are secure and the manifold bolts/nuts are tight.

1.7 Engine Speed:

Check engine speed and if adjustment is necessary, contact a Hyundai Equipment dealer.

1.8 Fan Drive:

Inspect fan, bolts, v-belt and guard to ensure there is no buildup of dirt, trash, or wear. Use compressed air to clean the area.

 **WARNING**

To avoid personal injury, lower the lift arms, shut off the engine, raise the seat bar and cycle the controls to ensure they are locked. Then, unlatch the seat belt and exit the loader. Do not enter or exit with the engine running unless as specified in this manual or under specific service and backhoe operating procedures.

IMPORTANT

Keep the rear door and radiator closed and latched except for servicing.

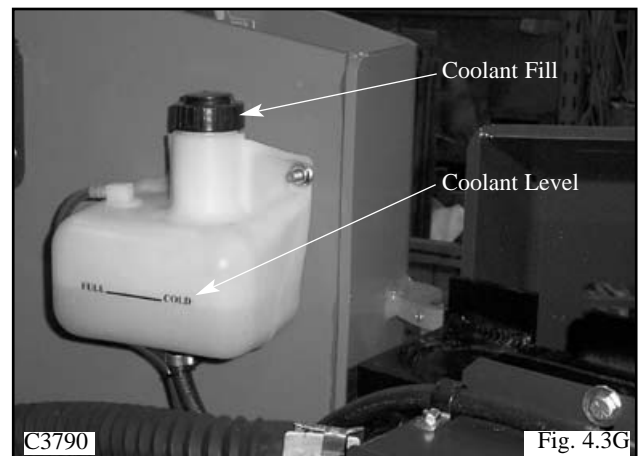

4. MAINTENANCE

2 Hydraulic/Hydrostatic

2.1 Hydraulic Oil Filter:

Change the hydraulic filter now and every 150 hours after the initial change. Lubricate the filter cartridge seal with system fluid.

2.2 Hydraulic Oil Level:

If oil is visible in the oil level sight glass the level satisfactory.

If additional oil is required use only 10W30 API classification SJ oil. Fill to the top or maximum check point.

2.3 Hoses and Pipes:

Make a visual inspection of all hydraulic lines and fittings for leaks. Check that steel lines do not touch one another.

2.4 Cylinders:

Inspect cylinders for leaks. Extend cylinders and check for rod damage.

2.5 Hydraulic Functions:

Check that the following operate properly: control valve float position, auxiliary hydraulics, pedals and hydraulic cylinders.

2.6 Pumps & Motors, Leakage:

Inspect pumps and motors for leaks.

2.7 Oil Cooler:

Inspect the oil cooler for leaks, fin damage or clogged with dirt. If necessary clean fins with compressed air.

3 Final Drive

3.1 Oil Level:

Check lubricating oil level. If necessary add 10W30 API classification SJ oil.

3.2 Drive Chain Condition:

Check drive chains for any sign of wear or damage. Check lubrication oil in housing for signs of contamination.

3.3 Hydrostatic Motor Mounting Bolts:

Check torque 85 - 90 ft. lbs. (115 - 122 Nm)

3.4 Bearing End Play:

Check the axle bearings for loss of bearing pre-load. If necessary, adjust the bearings for zero end play.

3.5 Axle Seal:

Inspect axle seal area. Clean area of debris build up and visually check for seal damage, replace as required.

4 Controls and Safety Equipment

4.1 Control Levers, Operation and Linkage:

Check that the steering levers operate freely without binding, they return to neutral when released and the machine travels in a straight line with both levers in forward position. Lubricate linkage with a silicone based lubricant.

4.2 Hydraulic Controls, Operation and Linkage:

Check that the hydraulic controls, foot pedals or hand controls operate freely without binding. Before leaving the operator seat, ensure the controls are locked.

Seat Bar Switch Check: Raise the seat bar and check that the hydraulic controls are locked in neutral.

Seat Belt Switch Check: Unbuckle the seat belt and check that the hydraulic controls are locked in neutral.

Seat Switch Check: With the seat bar down and the seat belt connected loosely around you, raise your weight off the seat and check that the controls are locked in neutral.

If the safety controls are malfunctioning or require adjustment, consult your Hyundai Equipment Dealer for service. Lubricate linkage with a silicone based lubricant.

4.3 Engine Throttle Control:

Check that the throttle control operates freely without binding or slackening off due to vibration.

4.4 Parking Brake:

Check that the parking brake engages and completely disengages. The park brake automatically engages with seat bar up.

4.5 Lift Arm Supports:

Check that the lift arm supports operate without binding.

NOTE: Ensure the lift arm supports are fully retracted before raising or lowering the lift arms.



4. MAINTENANCE

4.6 Quick-Tach, Operation & Linkage:
Ensure the quick-tach linkage operates smoothly without binding and engage completely.

4.7 Seat Belt:
Check seat belt condition. If necessary replace.

5 Electrical

5.1 Battery (s):
Maintenance Free.

5.2 Battery Terminals:
Check battery terminals for corrosion. If necessary, clean.

5.3 Starter Operation:
Engage and disengage the starter a few times to ensure it's working properly. To prevent starter damage do not engage for more than 15 seconds. Allow 1 minute between starting attempts for cooling the starter.

5.4 Operation of Electrical Equipment:
Make a complete check of all electrical equipment, gauges, warning devices, pre- heater indicator, work lights, seat and seat belt switch, seat bar switch and all optional equipment to ensure they are operating correctly.

6 Grease/Lubrication

Lubricate the following points with a good quality grease. Numbers marked () indicate the number of fittings at each location.

Rear Lift Arm Pivots (2)
Lift Arm Cylinder Bushings (4)
Bucket Cylinder Bushings (4)
Lift Arm Supports (2)
Quick - Tach Pivot (4)

7 General

7.1 Tire Pressure:
Check tire pressure and if necessary inflate to the following pressures:
12.00 x 16.5 40 - 45 PSI (207 - 241 kPa)

7.2 Wheel Nut Torque:
Check and torque wheel nuts to 100 - 110 ft. lbs. (136 - 149 Nm).

7.3 Condition of Cab:
Inspect both the seat and seat belt. Ensure all safety and instruction decals are in place. Inspect sound insulation, side windows and door operation for machines equipped with cab enclosure kits. Inspect for structural damage and alterations to R.O.P.S.

7.4 Condition of Shields and Safety Equipment:
Inspect and ensure all shields are in place and securely fastened. Inspect and ensure all safety equipment is working properly. Ensure owners and operators manual, safety manual and all safety and instruction decals are in place. If necessary, replace. If the safety controls are malfunctioning or require adjustment consult a **Hyundai** Equipment Dealer for service.

7.5 General Condition:
Make a general inspection of the machine looking for loose or missing parts, oil leaks, etc.

4.5 150 HOUR SERVICE CHECK

The following service check is to be performed by your dealer after the first 150 hours of operation.

1. It is recommended that the 50 hour check (see Section 4.4) be repeated at 150 hours.

4. MAINTENANCE

4.6 FINAL DRIVE MAINTENANCE

1. Oil Level Check

The loader has two independent final drive housings. Check the lubricating oil level with the loader on a level surface. Remove the check plug (Fig. 4.6A) located on the front of the loader to determine the oil level. The oil level should be checked after 50 operating hours and every 150 hours thereafter. It is recommended the oil be changed after 1000 operating hours or if it shows signs of contamination.

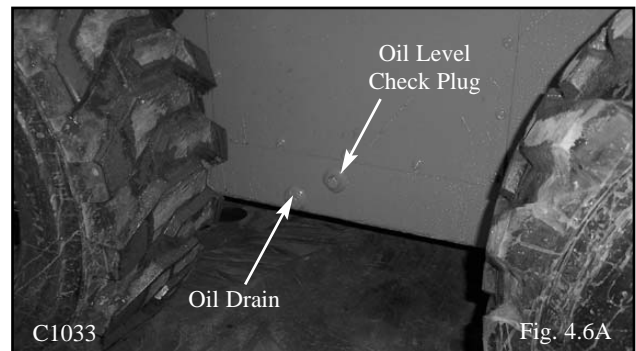

2. Adding Oil

Add oil with the loader on level ground. Remove the oil level check plug (Fig. 4.6A) on the final drive housing. Remove the seat and hydrostatic shield. Remove the filler cap (Fig. 4.6B). Fill with 10W30 API Classification SJ to the level of the check plug.

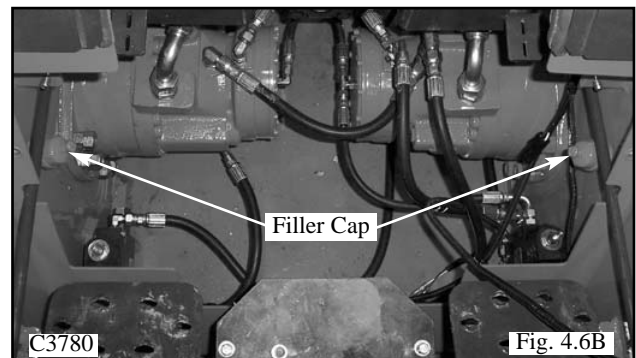

3. Drive Chain, Axle and Sprocket Inspection

The condition of the drive chains should be checked after the first 50 hours of operation and every 150 hours thereafter.

To inspect, block the loader securely with all four wheels off the ground. Remove both the front and rear wheels. On reassembly torque the wheel nuts to 100-110 ft. lbs. (136-149 N m). Remove the inspection cover on the side of the chain drive housing.

Inspect the chain for any sign of wear, damage or excessive looseness. Inspect the sprockets for any sign of damage or excessive wear. Inspect the lubricating oil for signs of contamination. Check the axle bearings for loss of bearing preload. If necessary adjust the bearings for zero end play.

Check the axle seals for leaking oil or damage. Replace seals at first sign of problem.

4. MAINTENANCE

4.7 HYDRAULIC/ HYDROSTATIC SYSTEM MAINTENANCE

1. Oil Level Check

Check the oil level of the hydraulic reservoir with the machine on a level surface with the lift arms down and the attachment grounded. Shut off the engine. Open the rear door and check the oil level sight gauge (Fig. 4.7A). If oil is apparent the level is satisfactory.

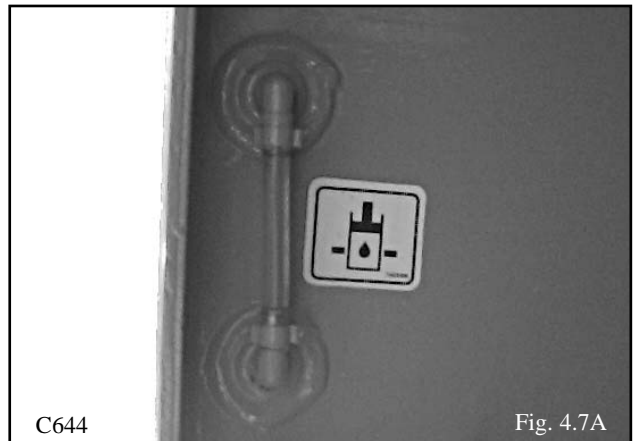

| | |
|--|---|
|  | <p>WARNING: Escaping hydraulic fluid under pressure can penetrate the skin causing serious injury.</p> <ul style="list-style-type: none">• DO NOT use your hand to check for leaks. Use a piece of cardboard or paper to search for leaks.• Stop engine and relieve pressure before connecting or disconnecting lines.• Tighten all connections before starting engine or pressurizing lines. <p>If any fluid is injected into the skin obtain medical attention immediately.</p> |
|--|---|

4. MAINTENANCE

2. Adding Oil

To add oil, remove the oil filler cap located at the top of the oil reservoir (Fig. 4.7B). Check and ensure the filter screen in the filler neck is undamaged. Add 10W30 API Classification SJ oil until oil is visible in the oil level sight glass (Fig. 4.7A).

3. Hydraulic Filter Replacement

The hydraulic oil filter (Fig. 4.7C) must be changed after the first 50 hours of operation and every 150 hours thereafter.

To change the filter; shut off the engine, lower the lift arms, ground any attachment and set the parking brake. Open the rear door and using an oil filter wrench remove the filter element. Lubricate the new filter seal with system fluid and reinstall hand tight. Note: The loader has one filter.

4. Draining System Fluid

Change the hydraulic oil:

1. After 1000 operating hours.
2. If the oil has become contaminated.
3. After any major hydrostatic repair.

To drain the oil: remove the drain plug located at the bottom of the reservoir (Fig. 4.7D). Have sufficient containers ready to hold the fluid. Remove any metal particles stuck to the magnet. Seal the plug with teflon tape when replacing.

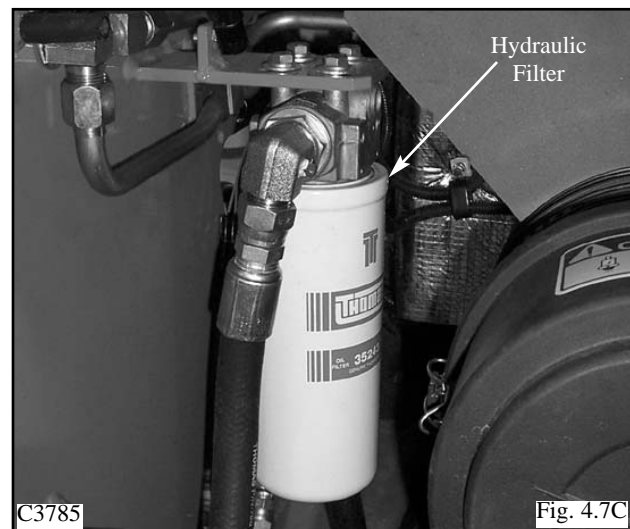
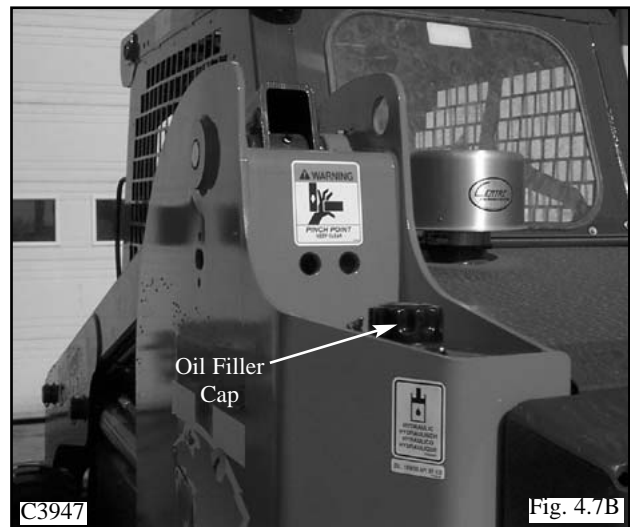

| | |
|------------------|---|
| IMPORTANT | Hyundai recommends that you abide by all applicable environmental regulations when disposing of oil. |
|------------------|---|

| | |
|--|--|
|  WARNING | To avoid personal injury, lower the lift arms, shut off the engine, raise the seat bar and cycle the controls to ensure they are locked. Then, unlatch the seat belt and exit the loader. Do not enter or exit with the engine running unless as specified in this manual or under specific service and backhoe operating procedures. |
|--|--|

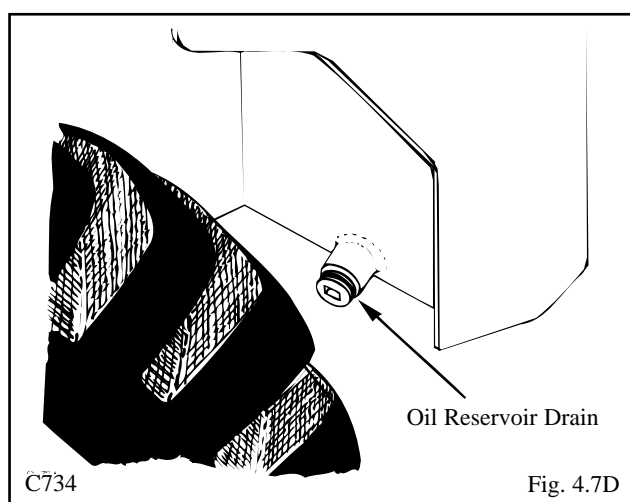

4. MAINTENANCE

5. Oil Cooler and Cooling Fan

Oil returning from the control valve is circulated through the oil cooler before being sent to other parts of the hydraulic system.

An engine cooling fan drives air through the oil cooler when the rear door is closed. Refer to Figure 4.7E.

The oil cooler should be checked daily for dirt buildup on the cooling fins. If the air flow is restricted through the cooling fins, overheating of the hydraulic system may occur. Clean any dirt buildup with compressed air. Figure 4.7E shows the radiator setup for the loader.

| | |
|--|---|
|  WARNING | To avoid eye injury always use safety goggles when cleaning with compressed air. |
|--|---|

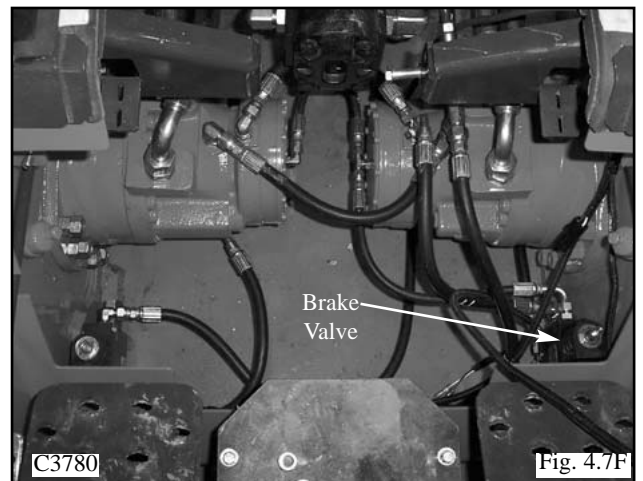
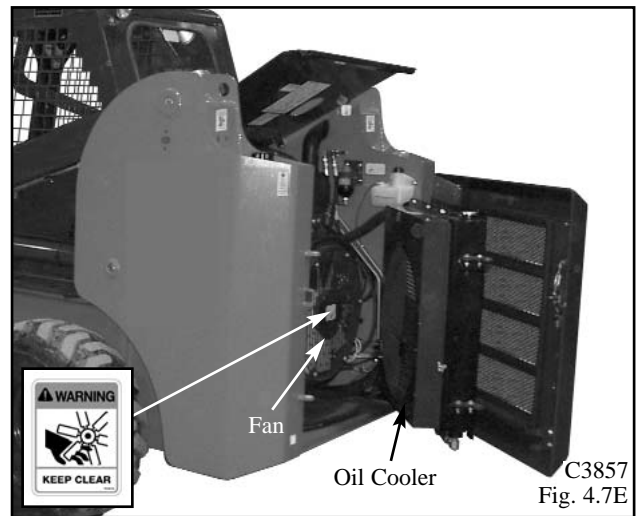

6. Brake Service Override

A service Override has been incorporated for use by Hyundai Dealers. The normal position of the plunger is down and turned into the locked position (Fig. 4.7F).

To release the park brake, turn the release button counter clockwise. Go to the rear of the machine and pressurize the small quick coupler (Fig. 4.7G) to 218 PSI (15 Bar) to release the park brake.

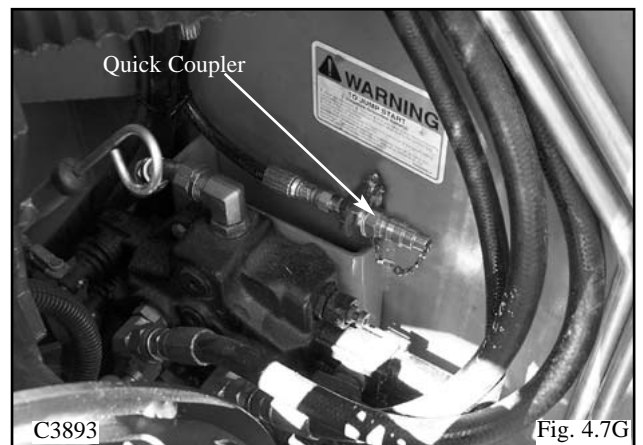

4. MAINTENANCE

4.8 ENGINE MAINTENANCE

1. Engine Specifications

| | |
|-------------------------------------|---|
| Make | Kubota |
| Model | V3300T |
| No. of Cyls | 4 |
| Horsepower (Gross) | 87.4 |
| Power (ISO 9249 Net Power) | 61.9 kW |
| Power CE (ISO 9249 Net Power) | 61.5 kW |
| Max. High Idle | 2750 RPM |
| Max. High Idle CE | 2500 RPM |
| Max. Torque | 206 ft. lbs. (280 N·m) @ 1400 |
| Displacement | 202.53 in. ³ (3318 cm ³) |
| Engine Oil | 14 qts. (13.2 L) |
| Firing Order | 1 - 3 - 4 - 2 |
| Alternator | 60 A |
| Oil Check | Daily |
| Oil Change | 150 hrs. |
| Filter Change | 300 hrs. |

2. Oil Level Check

Check the oil before engine start up. If the engine has been running let it cool for at least 5 minutes.

To check the oil level, stop the engine with the loader on level ground, open the rear door and remove the dipstick (Fig. 4.8A).

Keep the oil level between the full and low mark on the dipstick. Do not fill above the full mark.

3. Engine Oil and Filter Replacement

Operate the engine until warm, approximately 5 minutes. Stop the engine. Remove the oil drain plug located at the bottom of the oil pan. Remove the oil filter (Fig. 4.8B). Clean the filter housing surface. Put clean oil on the seal of the new filter and install the filter hand tight.

Replace the oil drain plug. Remove the filler cap and add 5W40 API classification CF engine oil. Start the engine and run for 5 minutes. Stop the engine and check for leaks at the filter. Recheck the oil level and add oil until the level

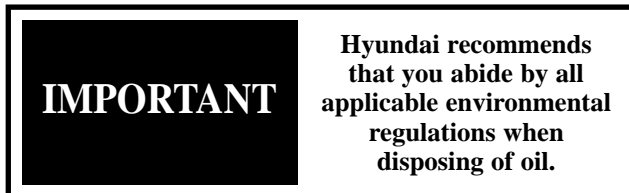
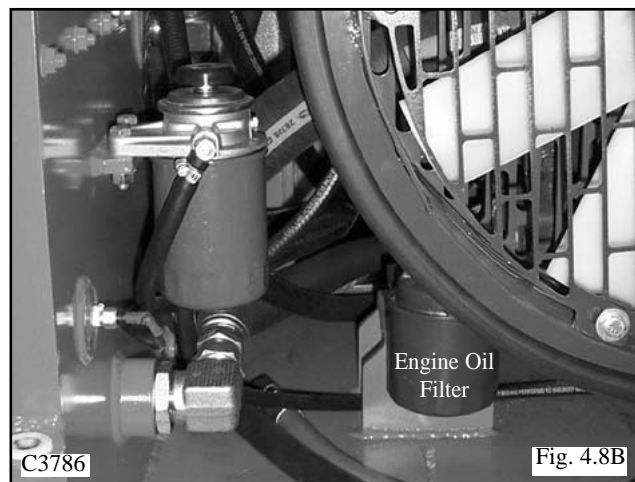
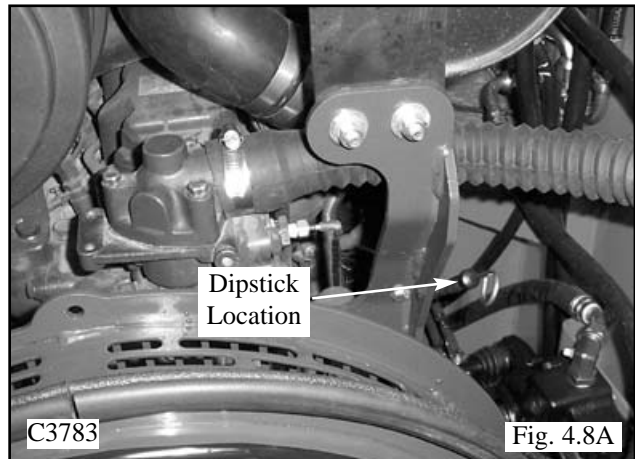
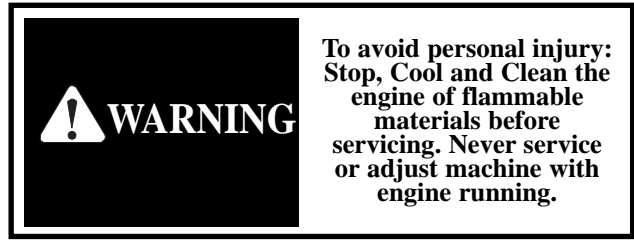

is at the top mark on the dipstick.

4. MAINTENANCE

4. V-Belt Tension

Check the V-belt tension midway between the crankshaft pulley and alternator pulley (Fig. 4.8C). Deflection should be between 1/4 to 3/8 in. (7-9 mm).

5. Adding Fuel

Use No. 2 diesel fuel only. Total tank capacity 28.7 gal (109 L). Before adding fuel to the loader the key switch must be off and the engine must be cool. Remove the fuel cap (Fig. 4.8D). Use a clean approved safety container to add fuel. Add fuel only in an area that is well ventilated and away from open flames or sparks - NO SMOKING!

6. Fuel Filter Replacement

The fuel filter is located in the engine compartment on the left hand side (Fig. 4.8E). The fuel filter should be removed every 100 hours and any water or dirt found in the element drained off. Change the filter every 300 hours.

To replace the filter; close the fuel inlet line shut - off located on the side of the fuel tank (Fig. 4.8F). Remove the filter element (Fig. 4.8E). Lubricate the seal on the new filter and install the filter hand tight. Open the fuel inlet shut - off. It may be necessary to remove air from the fuel system after changing the filter element. (Refer to Section 4.8-7).

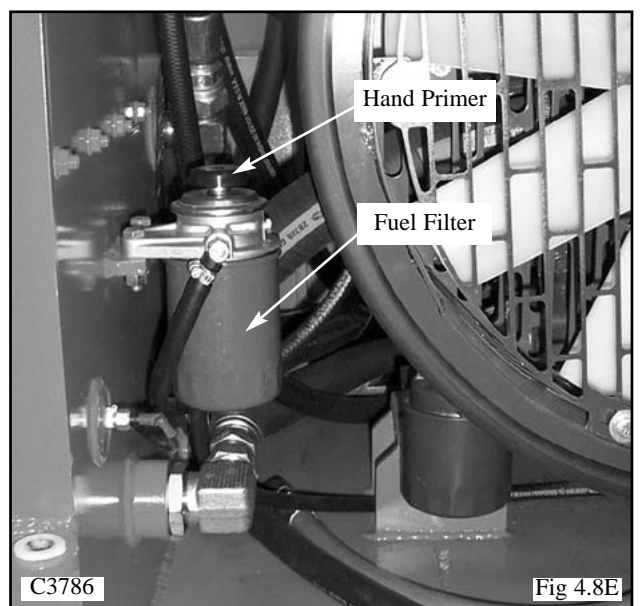
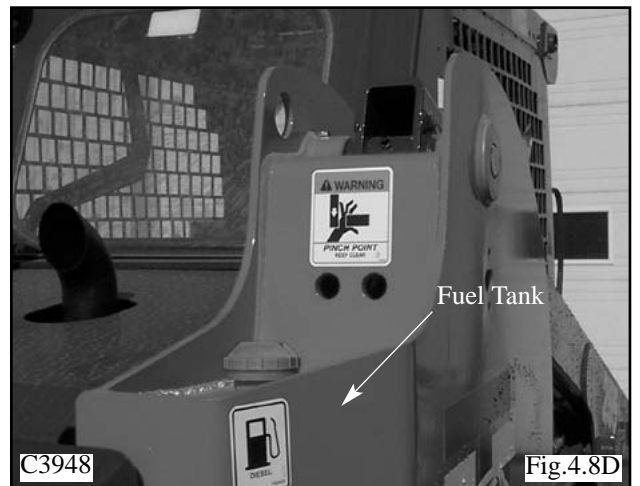
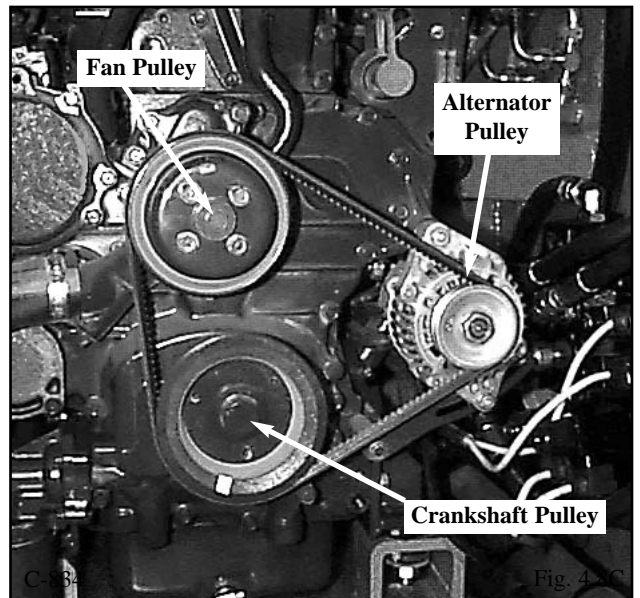

4. MAINTENANCE

7. Bleeding the Fuel System

Air must be removed from the fuel after replacement of the fuel filter element, or when the tank has been run out of fuel, before starting the engine.

To remove air, ensure the fuel inlet shut - off located on the side of the fuel tank is open (Fig. 4.8F). Open the bleed valve by turning it counter clockwise (Fig. 4.8G) on top of the injector pump. Place the throttle at idle, then turn the engine over with the starter. After the engine starts and runs smoothly, shut off the engine and close the bleed valve by turning it clockwise.

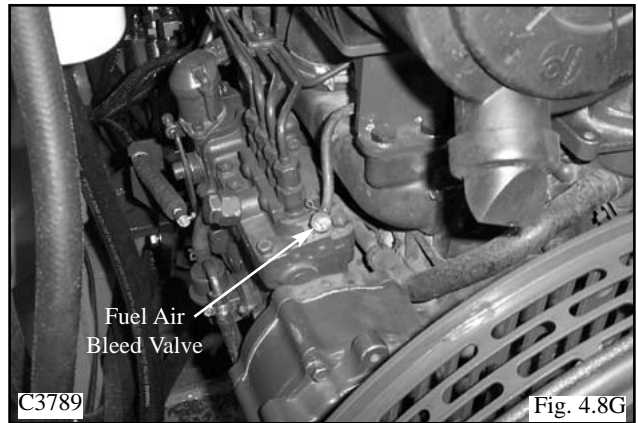
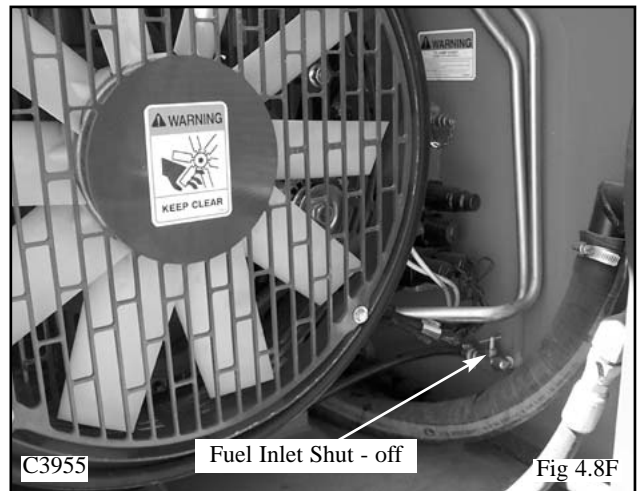

4. MAINTENANCE

4.9 AIR CLEANER MAINTENANCE

1. Daily Maintenance

Inspect the air cleaner canister for holes, dents, missing or mis-aligned gaskets. Check all hose clamps for tightness and inspect the hose and vacuator valve for damage (Fig. 4.9A).

2. Servicing Cleaner Element (Fig. 4.9B)

DO NOT open unless the indicator indicates a blocked filter or under normal scheduled servicing.

- 2.1 Unlatch and remove the cover assembly
- 2.2 Release the seal gently - The filter should be removed gently to reduce the amount of dust dislodged. Move the end of the filter up and down and side to side or twist to break the seal.
- 2.3 Avoid dislodging dust from the filter - Gently pull the filter off the outlet tube. Avoid knocking the filter against the housing.
- 2.4 Always clean the sealing surface of the outlet tube - Dust on the outside diameter of the housing could hinder an effective seal.
- 2.5 Always clean the inside of the outlet tube - Dirt inside of the outlet tube will reach the engine. It only takes 9 grams of dirt to dust an engine.
- 2.6 Check your old filter. Inspecting your old filter will detect foreign material on the sealing surface that may causing leakage.
- 2.7 Inspect the new filter for seal or pleat damage.
- 2.8 Insert the new filter properly - The seal area is on the inside of the open end of the primary filter. A new filter has a dry lubricant to aid installation. The critical sealing area will stretch slightly, adjust itself and distribute the sealing pressure evenly. To complete a tight seal, apply pressure at the outer rim of the filter, not the flexible centre. No cover pressure is required to hold the seal.
- 2.9 Check connections and ducts for air tight fit - Make sure all clamps, bolts and connections are tight. Check for holes in piping. Leaks here send dust directly to the engine.
- 2.10 DO NOT reuse filters by cleaning and reinserting.

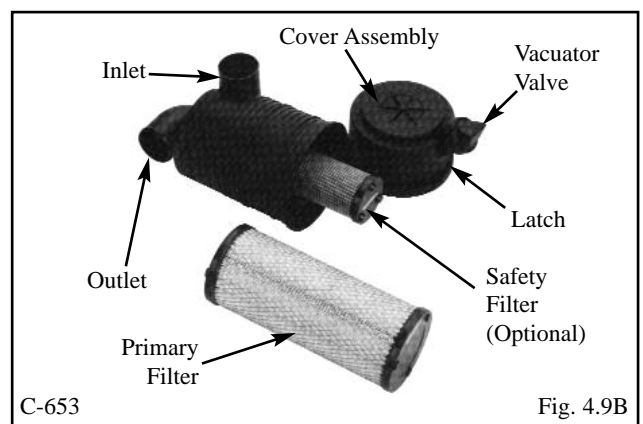
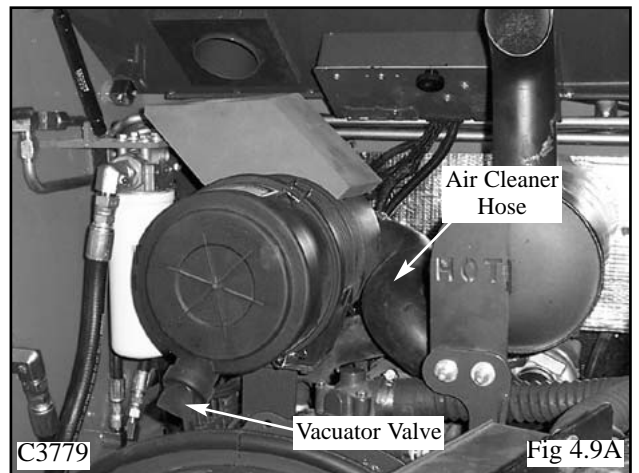

WARNING

To avoid personal injury: DO NOT charge a frozen battery because it can explode and cause personal injury. Let the battery warm to 60°F.(15.5°C.) before putting on a charger.

WARNING

To avoid personal injury, lower the lift arms, shut off the engine, raise the seat bar and cycle the controls to ensure they are locked. Then, unlatch the seat belt and exit the loader. Do not enter or exit with the engine running unless as specified in this manual or under specific service and backhoe operating procedures.

4. MAINTENANCE

4.10 ENGINE COOLING SYSTEM

The engine cooling system fluid is a 50 / 50 mixture of ethylene glycol and water.

To maintain the fluid level, add coolant to the overflow reservoir (Fig. 4.10A). The overflow reservoir should be checked daily when the engine is cold. Keep the coolant level to the line marked on the reservoir.

To drain the cooling system, turn the radiator petcock (Fig. 4.10B) in to open. Release the radiator cap. Remove the lower coolant hose from the engine to drain the coolant from the engine block.

Drain, flush and replenish the cooling system flush every two (2) years or every 1000 operating hours, whichever comes first.

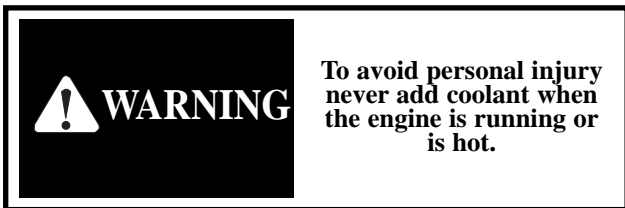
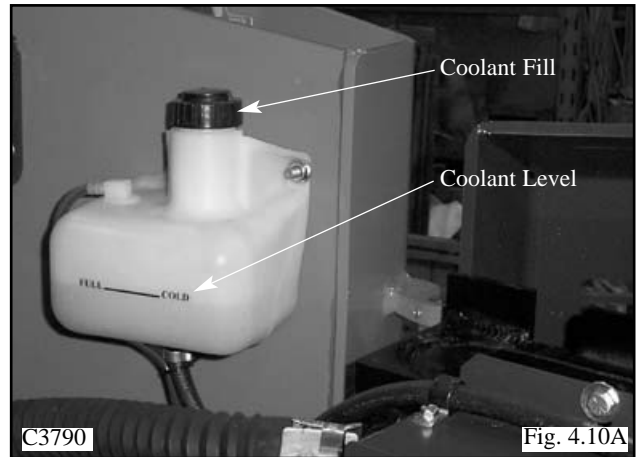

4. MAINTENANCE

4.11 ELECTRICAL SYSTEM

1. Battery Maintenance and Boosting

Inspect the batteries on a regular basis for damage such as a cracked or broken case or cover which would allow electrolyte loss.

Check the battery cables for tightness and corrosion. Remove any acid corrosion from the battery and cables with a baking soda and water solution. Coat the terminal connections with di-electric grease.

If it is necessary to use a booster battery to start the engine, BE CAREFUL! There must be one person in the operators seat and one person to connect and disconnect the battery cables.

BOOSTING PROCEDURES

The ignition must be in the OFF position. The booster battery to be used must be 12 volt. Connect the end of the first cable to the positive (+) terminal of the booster battery. Connect the other end of the same cable to the loader battery positive (+) terminal, or to the boosting lug. (See Fig 4.11A). Connect the end of the second cable to the negative (-) terminal of the booster battery. Connect the other end of the same cable to a ground. Keep cables away from moving parts. Start the engine. After the engine has started, disconnect the end of the second cable from the negative (-) terminal of the booster battery. Disconnect the other end of the same cable from the ground. Disconnect the end of the first cable from the positive (+) terminal of the booster battery. Disconnect the other end of the same cable from the loader battery positive (+) terminal, or boosting lug (See Fig 4.11A).

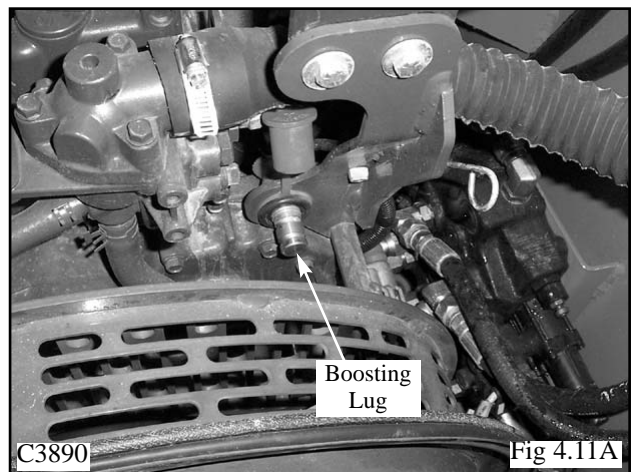
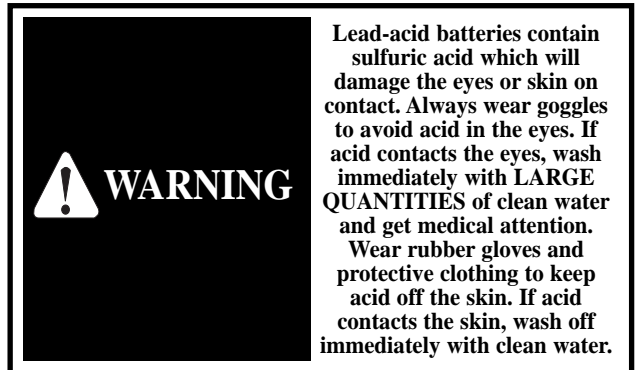
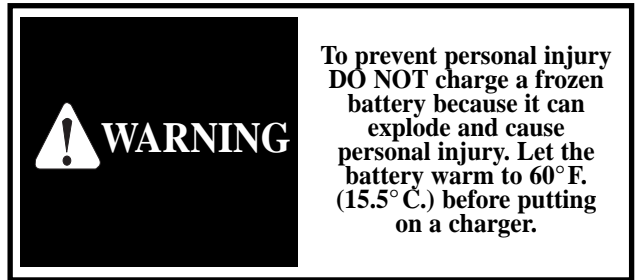

4. MAINTENANCE

2. ELECTRICAL SCHEMATIC – ROPS

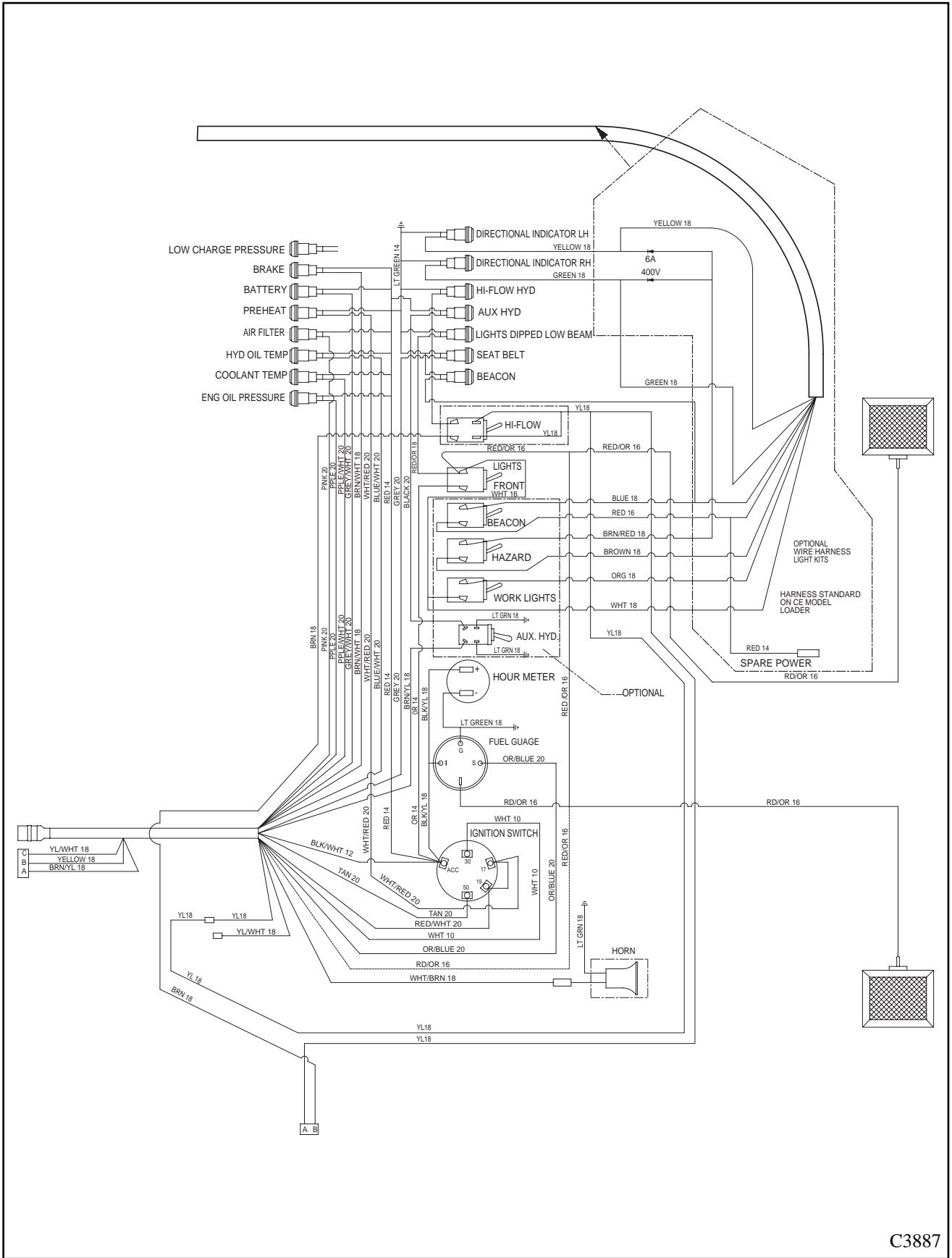

C3887

4. MAINTENANCE

3. ELECTRICAL SCHEMATIC – ENGINE

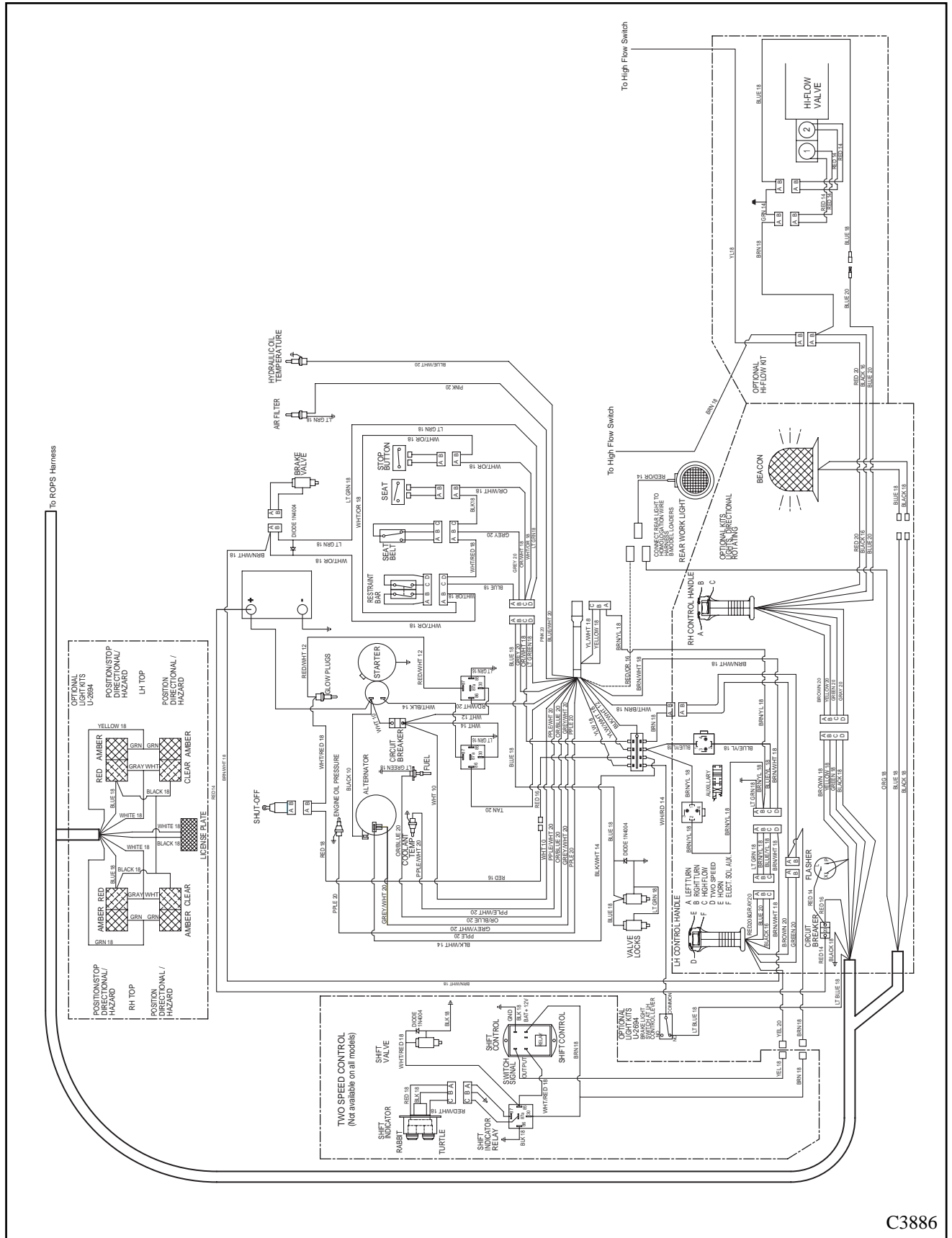

C3886

4. MAINTENANCE

4.12 TIRE MAINTENANCE

1. Tire Inflation and Service

- 1.1 Upon receiving your loader, check the air pressure in the tires as indicated in the tables.
- 1.2 Check tire pressure every 8 hours.
- 1.3 Tire inflation pressure affects the amount of weight which a tire may carry. Do not over-or-under inflate the tires.
- 1.4 Do not inflate a tire above the manufacturer's maximum pressure shown on the tire or the maximum pressure shown in the table.
- 1.5 Do not re-inflate a tire that has been run flat or seriously under-inflated until the tire has been inspected for damage by a qualified person.
- 1.6 When checking tire pressure, inspect the tire for damaged side walls and tread cuts. Neglected damage will lead to early tire failure.

WARNING

To avoid personal injury: Inflating or servicing tires can be dangerous. Trained personnel should be called to service and/or mount tires when possible. In any event to avoid possible serious or fatal injury, follow the safety precautions below.

- 1.7 Be sure the rim is clean and free of rust.
- 1.8 Lubricate both tire beads and rim flanges with soap solution. Do not use oil or grease.

WARNING

NEVER INFLATE TIRES TO OVER 240 kPa (35 PSI) TO SEAT BEADS. If beads have not seated by the time pressure reaches 240 kPa (35 PSI), deflate the assembly, reposition the tire on the rim, relubricate both tire beads, rim flanges and re-inflate. INFLATION Beyond 240 kPa (35 PSI) with unseated beads may break the bead or rim with EXPLOSIVE force, sufficient to cause serious injury.

- 1.9 Use a clip-on tire chuck with a remote hose and gauge which allows the operator to stand clear of the tire while inflating it.
- 1.10 After seating the beads, adjust inflation pressure to recommended operating pressure.
- 1.11 Do not inflate a tire unless the rim is mounted on the loader or is secured so that it will not move if the tire or rim should suddenly fail.
- 1.12 Do not weld, braze, or otherwise repair a rim, Do not use a damaged rim.
- 1.13 Never attempt tire repairs on a public road or highway.
- 1.14 Use jack stands or other suitable blocking to support the loader while repairing tires
- 1.15 Insure jack has adequate capacity to lift your loader.
- 1.16 Insure jack is placed on a firm level surface.
- 1.17 Do not put any part of your body under the loader or start the engine while the loader is on the jack.
- 1.18 Torque lug nuts to specification after reinstalling wheel. Check lug nut torque hourly until torque stabilizes.

| <i>Tire</i> | <i>Inflation Pressure</i> |
|--------------|---------------------------|
| 12.00 x 16.5 | 40-45 PSI (276 - 310 kPa) |

2. Tire Rotation

The front and rear tires will wear at different rates. For even wear move the front tires to the rear and the rear tires to the front when wear is first noticed.

If two tires become worn more than the other two put the two worn tires on the same side.

When new tires are installed, always keep tires the same size on the same side of the loader. Two different size tires on the same side of the loader will cause drive chain wear, tire wear and a loss of power..

4. MAINTENANCE

4.13 TROUBLESHOOTING

1. Hydraulic System

| Problem | Cause | Remedy |
|--|---|---|
| Loss of hydraulic power (no flow from gear pump) | Reservoir low on fluid | Replenish with 10W30 API SJ oil. Check for hose or fitting leaking. |
| | Coupling between engine and pump failure | Inspect and replace damaged parts. Check for misalignment between engine and pumps. |
| | Spline coupling failure between front and rear hydrostatic pump | Inspect coupling for sheared splines. Also check pump shaft bearings. |
| | Hydraulic gear pump not functioning | Inspect and repair. |
| Loss of hydraulic power (flow from gear pump) | Reservoir low on fluid | Replenish with 10W30 API SJ oil. |
| | Foot pedal linkage disconnected or binding | Inspect and adjust. |
| | Auxiliary hydraulics engaged | Disengage. |
| Hydraulic action jerky | Relief valve failure in control valve | Check pressure and adjust. |
| | Reservoir low on oil | Replenish with 10W30 API SJ oil. |
| | Air in hydraulic system | Check for leak between reservoir and pump. Bleed system by extending and retracting lift cylinders several times. |
| | Anticavitation check valve not functioning | Inspect and repair or replace. |
| Hydraulic Overheat | Engine fan not turning | Inspect fan v-belt. Adjust or replace. |
| | Incorrect temperature sensor | Replace. |
| | Reservoir low on fluid | Replenish with 10W30 API SJ oil. |
| | Oil cooler plugged or dirty (also check engine radiator) | Clean cooling fins. |
| | Auxiliary engaged | Disengage. |
| Lift arms raise slowly at full engine RPM | Reservoir low on oil | Replenish with 10W30 API SJ oil. |
| | Foot pedal linkage binding | Inspect and adjust. |
| | Auxiliary engaged | Disengage. |
| | Engine RPM too slow | Check RPM and reset. |
| | Anticavitation check valve spring broken | Replace. |
| | Main relief or port relief valve in control valve faulty | Check pressure, if necessary - adjust. |
| | Internal leakage in pump due to wear | Check pump flow and repair or replace as necessary. |
| | Oil bypassing one or both lift cylinder piston seals | Install new piston seal kits. |
| Lift or tilt cylinders will not support a load | External leak between or at control valve and cylinders | Check for leaks and correct. |
| | Control valve spool not centering | Check for sticking foot pedal linkages. |
| | | Check for broken or stuck return spring on valve spool. |
| Oil leaking by one or both cylinder piston seals | Install new piston seal kits. | |

Contact Hyundai Equipment for all major fixes under the remedy column except for regular service (ie. Replenish fluids, tightening etc.)

4. MAINTENANCE

1. Hydraulic System (Continued)

| Problem | Cause | Remedy |
|-------------------------------------|---------------------------------------|--|
| Foot pedals do not operate smoothly | Foot pedal linkages out of adjustment | Adjust foot pedal linkages. |
| | Foot pedal linkages need lubrication | Lubricate with a silicone based lubricant. |

2. Hydrostatic Drive

| Problem | Cause | Remedy |
|---|--|--|
| No power on one side (both directions) | Reservoir low on fluid | Replenish with 10W30 API SJ oil. Check for hose or fitting leak. |
| | Disconnected control linkage | Reconnect and adjust linkage. |
| | Bolt sheared on pump pintle lever | Replace. Check pintle lever for loose bolt or excessive play. |
| | High pressure line failure | Replace line. Ensure new line fits without being forced. If necessary stress relieve. |
| | Drive chain failure | Replace chain or connection link. Adjust tightener tension. |
| | Motor shaft or key failure | Inspect and repair defective parts. Check motor mounting bolts. |
| | Excessive internal leakage in motor and/or pump | Inspect and repair defective unit. Flush all lines and tank. Replace filter. Check on type of fluid used and engine RPM. |
| No power on one side (one direction only) | Defective relief valve | Replace defective valve. |
| No power on both sides (also loss of hydraulic power) | Reservoir low on oil | Replenish with 10W30 API SJ oil. Check for hose or fitting leaks. |
| | Coupling failure between engine and pump | Inspect and replace damaged parts. Check for misalignment between engine and pumps. |
| | Drive coupling between front and rear pump failure | Inspect couplings for sheared splines, replace. Also check support bearings in pumps. |
| | Check system pressure | If low, consult dealer or Hyundai Service Dept. |
| Gradual loss of power as machine warms up | Excessive internal leakage in pump and/or motor | Consult dealer or Hyundai Service Dept. |
| System erratic and/or noisy | Air in system due to low oil level in reservoir | Replenish with 10W30 API SJ oil. |
| | Air in system due to leak at suction fitting | Check fittings and tighten. |
| | Internal pump or motor wear caused by overspeeding | Consult your dealer or Hyundai Service Dept. |
| | Excessive play in linkage or pintle lever | Adjust linkage and tighten or replace pintle lever. |
| Machine will not travel in a straight line | Control levers binding | Check that shields are not stopping lever from full travel. |
| | | Adjust tracking. |

4. MAINTENANCE

3. Final Drive Transmission

| Problem | Cause | Remedy |
|--------------------------------|------------------------------|---|
| Final drive transmission noisy | No lubricating oil | Check and bring oil to the proper level. Use 10W30 API SJ engine oil. |
| | Axles have too much end play | Preload axle bearings removing all end play. |
| | Chain loose | Replace the chain. |

4. Control Levers

| Problem | Cause | Remedy | |
|--|---|--|---|
| Control levers will not center | Linkage out of adjustment | Adjust, check for wear at rod ends, loose counter nuts. | |
| | Linkage disconnected | Reconnect, check for wear at rod ends, loose counter nuts. | |
| | Centering spring broken | Replace | |
| | Linkage binding | Binding of spring bushing in spring box. Align spring box with linkage. | Control levers binding with safety shields or sound insulation. Adjust. |
| | | Control lever bearings binding in lever assembly. Inspect, replace or clean as required. | |
| Machine operates erratically | Control lever linkage loose | Inspect linkage for wear at rod ends, loose counter nuts. | |
| | Bolt in pintle lever worn or broken | Replace bolt. Inspect pintle lever for wear at bolt hole. Ensure bolt clamping lever to pump shaft is tight. | |
| | | See also troubleshooting guide for hydrostatic system. | |
| Machine will not travel in a straight line | Linkage binding | Adjust. | |
| | Control lever travel out of adjustment | Adjust. | |
| Control levers do not operate smoothly | Internal pump and/or motor linkage | See troubleshooting hydrostatic system. | |
| | Control lever linkages out of adjustment. | Adjust control lever linkages. | |
| | Control lever linkages need lubrication. | Lubricate with a silicone based lubricant. | |

5. Electrical

| Problem | Cause | Remedy |
|----------------------------|-----------------------|---|
| Engine will not crank over | Battery failure | Check battery - charge or replace. |
| | Battery cable failure | Check for loose or corroded connectors. Tighten and clean as required. Use di-electric grease to prevent corrosion. |
| | | Check continuity of cables and replace. |
| | Starter failure | Repair or replace. |

4. MAINTENANCE

5. Electrical (Continued)

| Problem | Cause | Remedy |
|---|---|---|
| Engine will not crank over (continued) | Fuse burnt | Check and replace. |
| | Defective relay | Check relay continuity. If defective, replace. |
| | Ignition switch failure | Check continuity, repair or replace. |
| Engine cranks over, but will not start | Auxiliary hydraulics engaged | Engine will smoke, but not run unassisted by starter. Disengage auxiliary hydraulics. |
| | Defective glow plug relay | Check continuity and if defective, replace. |
| | Defective glow plug | Check continuity and if defective, replace. |
| | Broken connection or defective wire | Disconnect the ROPS harness from the engine harness. Open the dash panel and check continuity of the circuit not functioning properly in both engine and ROPS harness. |
| Loader starts, but hydraulic controls will not release. | No fuel | Check fuel levels and system. |
| | Electric solenoids not releasing valve spools | Defective solenoid or binding solenoid locks. Loosen screws and re-adjust. Check continuity of connectors, seat bar switch, seat switch, seat belt switch and wires. |

6. Engine

| Problem | Cause | Remedy |
|----------------------------|---|---|
| Engine does not start | No fuel | Replenish fuel. |
| | Air in the fuel | Vent air. |
| | Water in the fuel | Change fuel and repair or replace fuel system. |
| | Fuel pipe clogged | Clean. |
| | Fuel filter clogged | Clean or change. |
| | Excessively high viscosity of fuel or engine oil at low temperature | Use the specified fuel or engine oil. |
| | Fuel with low octane number | Use the specified fuel. |
| | Fuel leak due to loose injection pipe retaining nut | Tighten nut. |
| | Incorrect injection timing | Adjust. |
| | Fuel cam shaft worn | Replace. |
| | Injection nozzle clogged | Clean. |
| | Injection pump malfunctioning | Repair or replace. |
| | Seizure of crankshaft, camshaft, piston, cylinder liner or bearing | Repair or replace. |
| | Compression leak from cylinder | Replace head gasket, tighten cylinder head bolt, glow plug and nozzle holder. |
| | Improper valve timing | Correct or replace timing gear. |
| Piston ring and liner worn | Replace. | |
| Excessive valve clearance | Adjust. | |

4. MAINTENANCE

6. Engine (Continued)

| Problem | Cause | Remedy |
|---|---|--------------------------------|
| Starter does not run | Battery discharged | Charge. |
| | Starter malfunctioning | Repair or replace. |
| | Key switch malfunctioning | Repair or replace. |
| | Wiring disconnected | Connect. |
| Engine revolution is not smooth | Fuel filter clogged or dirty | Clean or change. |
| | Air cleaner clogged | Clean or change. |
| | Fuel leak due to loose injection pipe retaining nut | Tighten nut. |
| | Injection pump malfunctioning | Repair or replace. |
| | Incorrect nozzle opening pressure | Adjust. |
| | Injection nozzle stuck or clogged | Repair or replace. |
| | Fuel overflow pipe clogged | Clean. |
| | Governor malfunctioning | Repair. |
| Either white or blue exhaust gas is observed | Excessive engine oil | Reduce to the specified level. |
| | Low grade fuel used | Repair or replace. |
| | Fuel filter clogged | Adjust. |
| | Air cleaner clogged | Adjust top clearance. |
| Either black or dark gray exhaust gas is observed | Overload | Lessen the load. |
| | Low grade fuel used | Use the specified fuel. |
| | Fuel filter clogged | Clean or change. |
| | Air cleaner clogged | Clean or change. |
| Excessive lubricant oil consumption | Piston rings gap facing the same direction | Shift gap direction. |
| | Oil ring worn or stuck | Replace. |
| | Piston ring groove worn | Replace. |
| | Valve stem and guide worn | Replace. |
| | Crankshaft bearing and crank pin bearing worn | Replace. |
| Fuel mixed into lubricant oil | Injection pump's plunger worn | Replace pump element or pump. |
| | Injection pump broken | Replace. |
| Water mixed into lubricant oil | Head gasket defective | Replace. |
| | Cylinder block or cylinder head flawed | Replace. |
| Low oil pressure | Engine oil insufficient | Replenish. |
| | Oil strainer clogged | Clean. |
| | Relief valve stuck with dirt | Clean. |
| | Relief valve spring weakened or broken | Replace. |
| | Excessive oil clearance of crankshaft bearing | Replace. |
| | Excessive oil clearance of crank pin bearing | Replace. |
| | Excessive oil clearance of rocker arm bearing | Replace. |
| | Oil passage clogged | Clean. |
| | Oil pump defective | Replace. |
| High oil pressure | Different type of oil | Use the specified oil type. |
| | Relief valve defective | Replace. |

4. MAINTENANCE

6. Engine (Continued)

| Problem | Cause | Remedy |
|----------------------------|---|---|
| Engine overheated | Engine oil insufficient | Replenish. |
| | Fan belt broken or elongated | Change or adjust. |
| | Cooling water insufficient | Replenish. |
| | Radiator net and radiator fin clogged with dust | Clean. |
| | Inside of radiator corroded | Clean or replace. |
| | Cooling water flow route corroded | Clean or replace. |
| | Radiator cap defective | Replace. |
| | Overload running | Lessen the load. |
| | Head gasket defective | Replace. |
| | Incorrect injection timing | Adjust. |
| | Unsuitable fuel used | Use the specified fuel. |
| Deficient output | Incorrect injection timing | Adjust. |
| | Engine's moving parts seem to be seizing | Repair or replace. |
| | Uneven fuel injection | Repair or replace injection pump. |
| | Deficient nozzle injection | Repair or replace nozzle. |
| | Compression leak | Replace head gasket, tighten cylinder head bolt, glow plug and nozzle holder. |
| Battery quickly discharges | Battery electrolyte insufficient | Replenish distilled water recharge. |
| | Fan belt slips | Adjust belt tension or charge. |
| | Wiring disconnected | Connect. |
| | Rectifier defective | Replace. |
| | Alternator defective | Replace. |
| | Battery defective | Change. |

4. MAINTENANCE

4.14 HYDRAULIC / HYDROSTATIC CIRCUIT

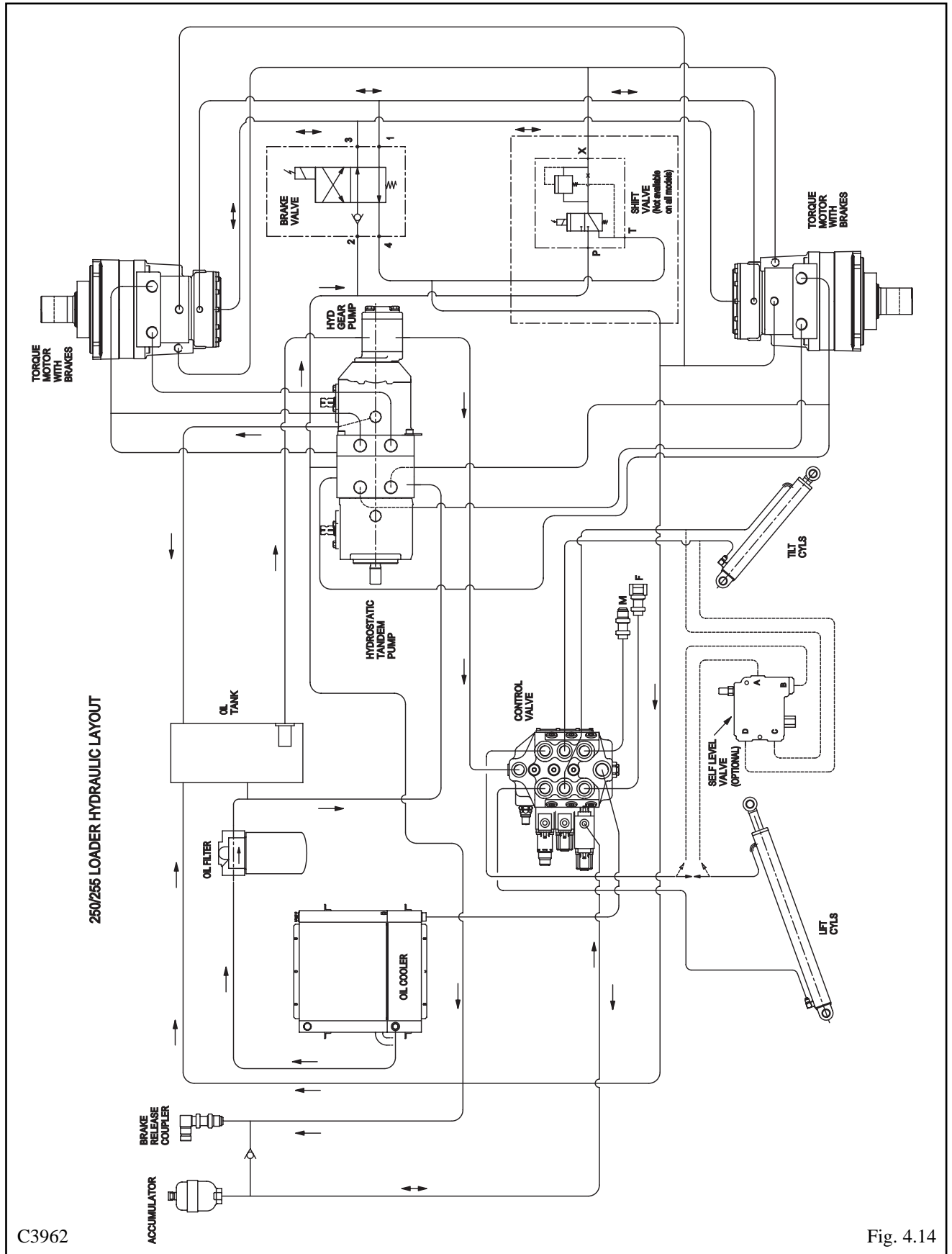

C3962

Fig. 4.14



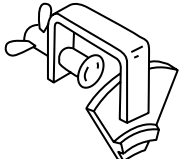
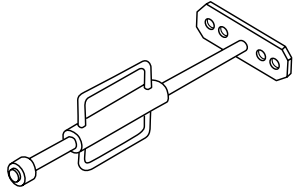
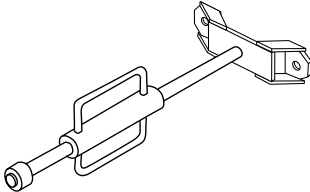
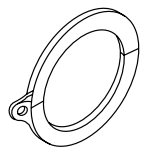
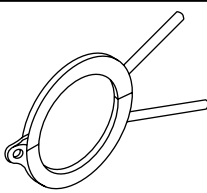
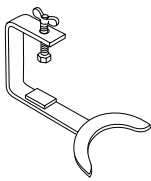
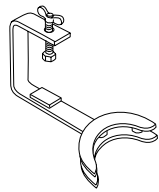
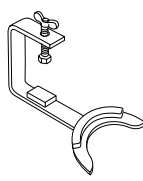
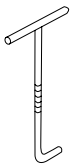

4. MAINTENANCE

4.15 SPECIAL TOOLS

| Part # | ILLUSTRATION | DESCRIPTION | MODEL |
|--------------------|--|---|-------------------|
| 962201 |  C3651 | SEAL INSTALLATION TOOL: To install axle seal in final drive housing. Qty. 3 required | HSL500T |
| 955281 | | | HSL680T |
| 955283 (6 Bolt) |  C3652 | AXLE EXTRACTOR TOOL: To remove axle from final drive housing. Qty. 1 | HSL500T, HSL680T |
| 960475 (8 Bolt) |  C3653 | AXLE EXTRACTOR TOOL: To remove axle from final drive housing. Qty. 1 | HSL800T, HSL1200T |
| 960986 |  C3654 | SEAL INSTALLATION TOOL: To install axle seal in final drive housing. Qty. 1 | HSL400T |
| 955287 |  C3655 | SEAL INSTALLATION TOOL: To install axle seal in final drive housing. Qty. 1 | |
| 957189 |  C3656 | SEAL INSTALLATION TOOL: To install axle seal in final drive housing. Qty. 2 required | |
| 958674 |  C3657 | SEAL INSTALLATION TOOL: To install axle seal in final drive housing. Qty. 2 required | HSL800T |
| 964613 |  C3895 | SEAL INSTALLATION TOOL: To install axle seal in final drive housing. Qty. 2 required | HSL1200T |
| 960997 |  C3658 | CHAIN TENSION TOOL: To test chain tension. | HSL680T |

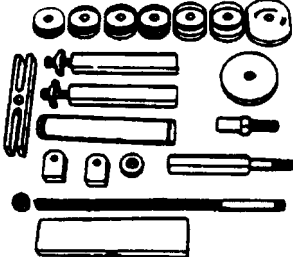
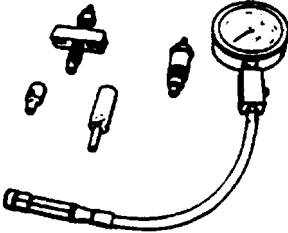
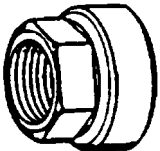





4. MAINTENANCE

4.15 SPECIAL TOOLS (Cont'd)

| Part # | ILLUSTRATION | DESCRIPTION | MODEL |
|---------------------------|---|--|------------|
| U-1288 |  | <p>UNIVERSAL TOOL KIT: 1 each. Combination wrench 7/16", 1/2", 9/16", 11/16", 3/4", 1 1/16", 1 1/4". Sockets, 1", 1/2" drive, 7/8", 1/2" drive, tool pouch, allen wrench 5/32" and 1/8".</p> | ALL MODELS |
| 916-30042 - 01 25197 |  | <p>DRY LINER PULLER: Used for removing and installing the dry liner of the engine.</p> <p>Consists of: 304742 (64mm); 304743 (68mm); 30744 (75mm); 304745 (76mm); 304746 (82mm); 304747 (105mm); Removing Plates; 304748 Installing Plate</p> | KUBOTA |
| 07909-30202 - 01 25198 |  | <p>DIESEL ENGINE COMPRESSION TESTER: Used to measure diesel engine compression and diagnosis of need for major overhaul.</p> | KUBOTA |
| 07916-30820 - 01 25199 |  | <p>CRANKSHAFT NUT SOCKET: Used to take off and fix the crankshaft nut. (46 mm).</p> | KUBOTA |
| 07916-30840 - 01 25200 |  | <p>NOZZLE REMOVER SOCKET: Used to unfasten the screw type nozzle holders.</p> | KUBOTA |
| 70090-01125 - 01 25201 |  | <p>NOZZLE DISASSEMBLY SOCKET: Used in place of a vice for disassembly and repair of nozzles.</p> | KUBOTA |
| 960456 |  | <p>HYDRAULIC FLOW AND PRESSURE GAUGE ASSEMBLY</p> | ALL MODELS |

4. MAINTENANCE

4.15 SPECIAL TOOLS (Cont'd)

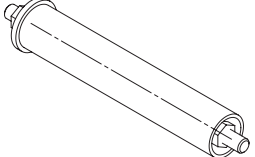
| Part # | ILLUSTRATION | DESCRIPTION | MODEL |
|--------|--|--|------------|
| 43979 |  C1840 | CHAIN PULLER | ALL MODELS |
| 43980 |  C1841 | SPANNER WRENCH 2'' - 4 3/4'': To Repair Hydraulic Cylinders | ALL MODELS |
| 43981 |  C1837 | PHOTO SENSOR / WHEEL SPEED TACHOMETER (Dual Function) | ALL MODELS |
| |  C1839 | FORCE GAUGE, PUSH PULL: For Measuring Restraint Bar Brake Cable Adjustment. Special Order Only | HSL1200T |
| |  C2342 | MULTI METER: For measuring continuity, voltage, etc. | ALL MODELS |
| |  C2343 | ANGLE FINDER: For measuring control angles, U-joint and chassis angles etc. | ALL MODELS |
| 964659 |  C4117 | PIN REMOVAL TOOL | HSL960T |

5. SPECIFICATIONS

5. SPECIFICATIONS

- 5.1 Loader Specifications
- 5.2 Torque Specifications
- 5.3 Decals

5. SPECIFICATIONS

Controls

VEHICLE: Steering direction and speed controlled by two hand operated control levers.
 HYDRAULICS: Lift and bucket tilt are controlled by separate foot pedals or hand controls. Auxiliary hydraulics controlled by electric solenoid.
 ENGINE: Hand throttle, key type ignition switch and shutoff.

Engine

Make and modelKubota V3300-T
 Cylinders4
 Cooling systemLiquid
 Displacement202.5 in³ (3318 cm³)
 Horsepower (Gross)87.4
 Power (ISO 9249 Net Power)61.9 kW
 Power (ISO 9249 Net Power) CE61.5 kW
 Max Torque.....205 ft. lbs. (280 N m @ 1400 RPM)
 Fuel Type.....Diesel No.2
 Air CleanerReplaceable Dry Cartridge w/Indicator
 Maximum RPM (no load)2750
 Maximum RPM (no load) CE.....2500

Hydraulic System

Pump typeGear
 Pump Capacity (theoretical) @ 2750 RPM21.0 GPM (79.5 L/min)
 Pump Capacity (theoretical) @ 2500 RPM.....19.2 GPM (72.7 L/min)
 System Relief Setting3000 PSI (206.8 bar)
 Control ValveSeries type with float on lift and electrical auxiliary
 Filtration5 Micron
 Hydraulic Fluid.....10W30 API Class, SJ
 Oil Cooler1250 BTU/min (315 kCal)

HSL1200T

| | | |
|---------------------|---------------|---------------|
| Cylinders. | Lift | Tilt |
| Type..... | Double acting | Double acting |
| Qty- per mach | 2 | 2 |
| Bore dia | 3 in | 3 in. |
| Rod dia | 2 in | 2 in. |
| Stroke | 27.9 in | 15.5 in. |

Hydrostatic Transmission & Final Drive:

Pump typeTwo in line, axial piston pumps
 Pump displacement2.80 in³ (46 cm³)
 Motor typeRadial Piston
 Motor displacement (250).....41.5 in³ (680 cm³)
 (255 Low Speed).....45.8 in³ (750 cm³)
 (255 High Speed)24.9 in³ (408 cm³)
 System relief setting5000 PSI (345 bar)
 Final driveSingle roller chain running in oil bath to each axle
 Drive chain sizeASA 100H

5. SPECIFICATIONS

Electrical

| | |
|-------------------------------|-----------------|
| Alternator | 60 A |
| Battery | 2 x 12V |
| Type (BCI GROUP)..... | 34/78 |
| Cranking Amps | 730 each (1460) |
| Starter..... | 12 V (2.5 kW) |
| Circuit breaker setting | 40 A |

Tires

| | |
|----------------|---|
| Standard | 12.00 x 16.5, 6 ply rating, 40-45 PSI (276-310 kPa) |
|----------------|---|

Fluid Capacities

| | | |
|--|------------------------|-------------------------------|
| Fuel tank | 28.7 gal. (109 L)..... | Diesel No. 2 |
| Final drive transmissions (each) | 4.5 gal. (17 L) | 10W30 API SJ |
| Hydraulic reservoir | 35 gal. (133 L) | 10W30 API SJ |
| Engine oil | 14 qt. (13.2 L)..... | 5W40 API CF |
| Engine cooling system | 4.2 gal. (16 L)..... | 50/50 water & ethylene glycol |

5.2 TORQUE SPECIFICATIONS

Loader

| | |
|-----------------------|----------------------------------|
| Wheel nuts (24) | 100 - 110 ft lbs. (136 - 149 Nm) |
|-----------------------|----------------------------------|

FOR NON-CRITICAL AND NOT OTHERWISE MENTIONED APPLICATIONS. THE FOLLOWING GENERAL ASSEMBLY TORQUES WILL APPLY:

| <i>Bolts & Nuts</i> | <i>Torque Lbs. ft. (Nm)</i> |
|-------------------------|---------------------------------|
| 1/4 - 20 | 5 - 7 (6.7 - 9.5) |
| 5/16 - 18 | 12 - 15 (16 - 20) |
| 5/16 - 24 | 12 - 15 (16 - 20) |
| 3/8 - 16 | 17 - 22 (23 - 30) |
| 3/8 - 24 | 22 - 27 (30 - 37) |
| 7/16 - 14 | 30 - 35 (41 - 47) |
| 7/16 - 20 | 40 - 45 (54 - 61) |
| 1/2 - 13 | 45 - 50 (61 - 68) |
| 1/2 - 20 | 50 - 60 (68 - 81) |
| 9/16 - 12 | 60 - 70 (81 - 95) |
| 9/16 - 18 | 65 - 75 (88 - 102) |
| 5/8 - 11 | 75 - 85 (102 - 115) |
| 5/8 - 18 | 100 - 110 (136 - 149) |

5. SPECIFICATIONS

5.3 DECALS (HSL1200T)

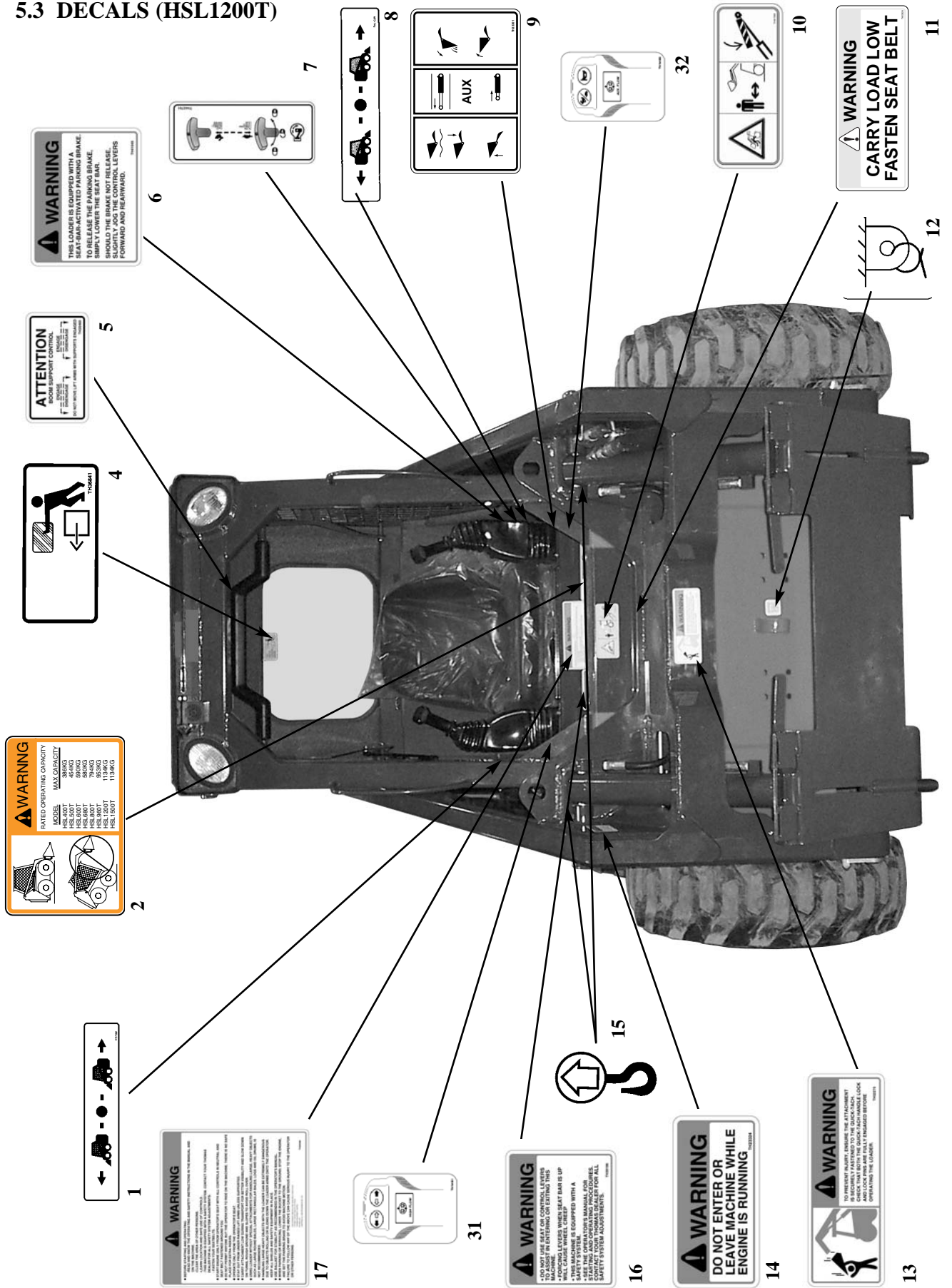

5. SPECIFICATIONS

5.3 DECALS (HSL1200T)

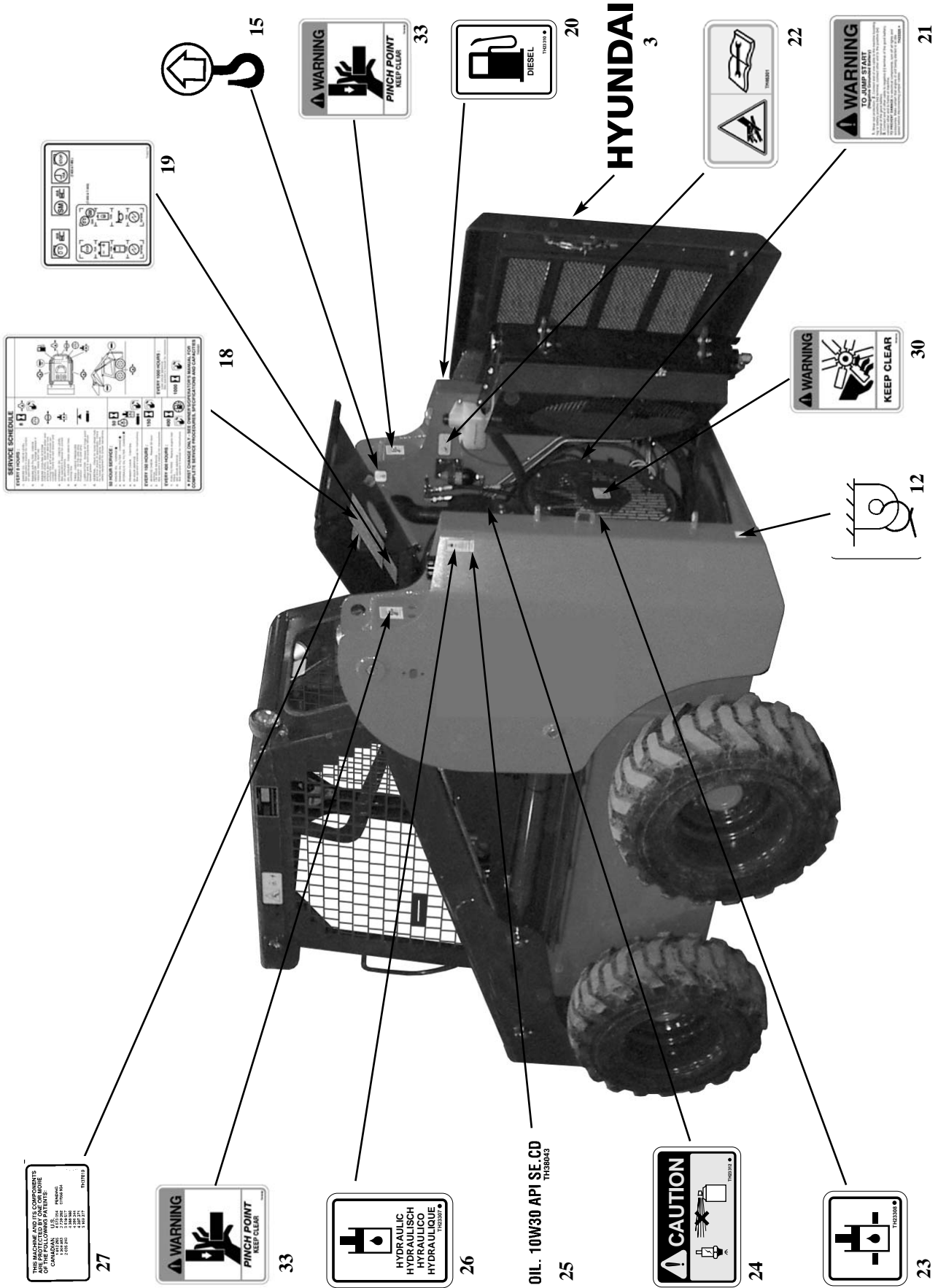

5. SPECIFICATIONS

5.3 DECALS (255)

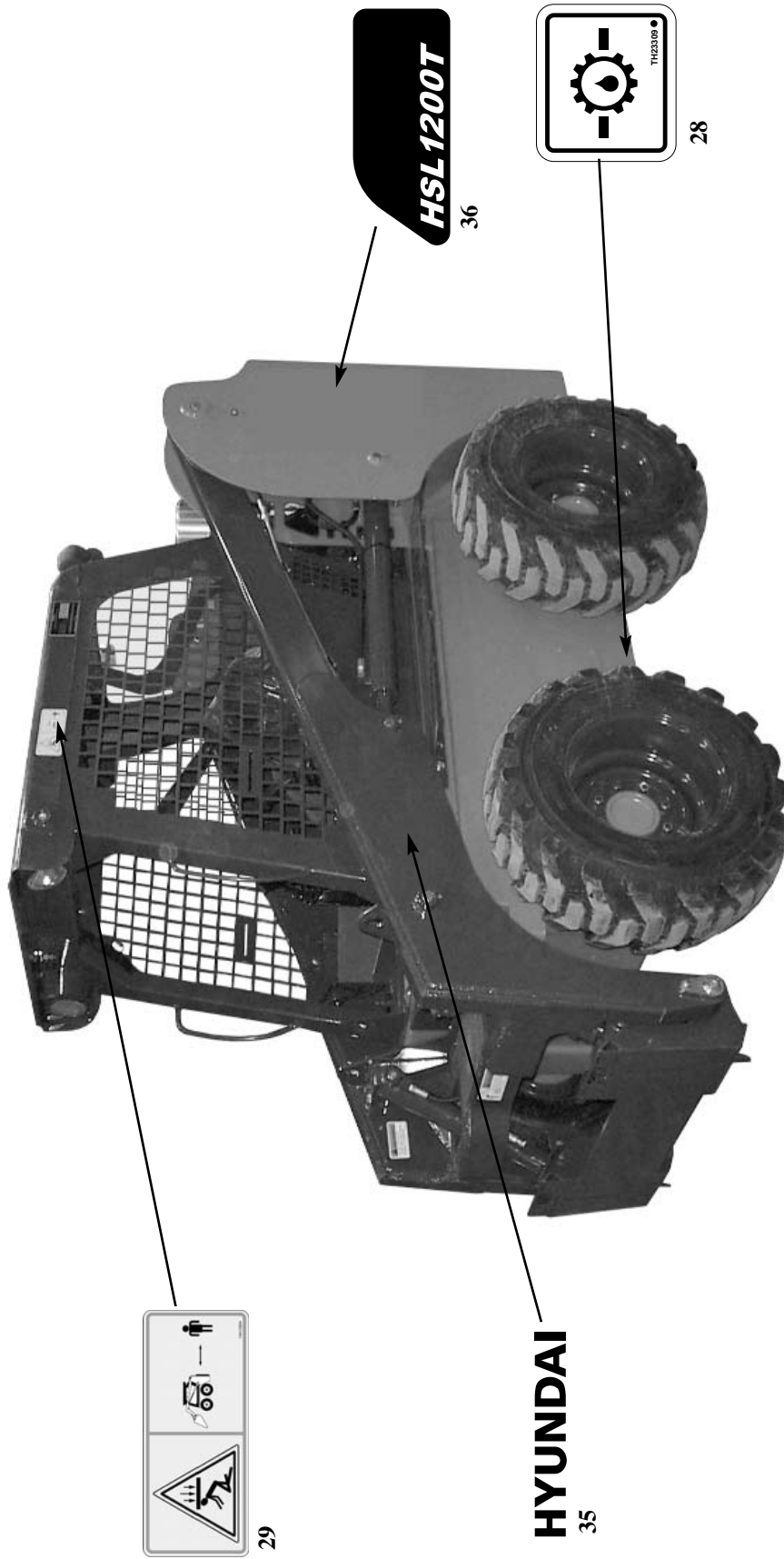

| | | | | | | | |
|----|-------|-----|-------|-----|-------|-----|-------------------------------------|
| 1. | 37060 | 10. | 41066 | 19. | 43766 | 28. | 23309 |
| 2. | 42107 | 11. | 23326 | 20. | 23310 | 29. | 41065 |
| 3. | 52329 | 12. | 39192 | 21. | 23325 | 30. | 49019 |
| 4. | 36841 | 13. | 32275 | 22. | 46301 | 31. | 49021 |
| 5. | 25460 | 14. | 23324 | 23. | 23308 | 32. | 49022 |
| 6. | 41045 | 15. | 39191 | 24. | 23312 | 33. | 49020 |
| 7. | 43791 | 16. | 39196 | 25. | 38043 | 34. | 49023 (Not available on all models) |
| 8. | 37059 | 17. | 36598 | 26. | 23307 | 35. | 52330 |
| 9. | 23301 | 18. | 23321 | 27. | 37010 | 36. | 52332 |

6. ATTACHMENTS AND BUCKETS

6. ATTACHMENTS AND BUCKETS

6. 1 Hyundai Approved Buckets and Attachments

6. ATTACHMENTS AND BUCKETS

6.1 HYUNDAI APPROVED BUCKETS AND ATTACHMENTS

BUCKETS

| Cat. # | Description | SAE Heaped Capacity (ft ³) | Approx. Weight |
|--------|-------------------------------------|--|----------------|
| 1890 | 68" Dirt Bucket | 13.3 | 434 lb |
| 1889 | 73" Dirt Bucket | 14.3 | 456 lb |
| 2454 | 78" Dirt Bucket | 15.8 | 488 lb |
| 2002 | 68" Fertilizer Bucket | 20.6 | 396 lb |
| 2003 | 72" High Capacity Fertilizer Bucket | 26.0 | 565 lb |
| 1936 | 73" Utility Bucket | 16.8 | 480 lb |
| 1956 | 78" Snow and Light Material Bucket | 28.3 | 518 lb |
| 2008 | 72" Produce Bucket | 31.5 | 562 lb |
| 2009 | 78" Produce Bucket | 34.3 | 604 lb |

BUCKET OPTIONS

| Cat. # | Description | Approx. Weight |
|--------|---|----------------|
| 2443 | Toothbar Complete for 73" Dirt Bucket | 101 lb |
| 2444 | Toothbar Complete for 78" Dirt Bucket | 109 lb |
| 2452 | 9 Tooth Kit, Painted for 68" & 73" Bucket | 20 lb |
| 2453 | 10 Tooth Kit, Painted for 78" Bucket | 22 lb |
| 2457 | Kit, Bolt-on Edge for 73" Bucket | 101 lb |
| 2458 | Kit, Bolt-on Edge for 78" Bucket | 109 lb |

PALLET FORKS

| Cat. # | Description | Approx. Weight |
|--------|------------------------------------|----------------|
| 2330 | Pallet Fork Frame (Requires Tines) | 226 lb |
| 99 | 30" Tines (Set of 2) | 110 lb |
| 98 | 36" Tines (Set of 2) | 138 lb |
| 437 | 42" Tines (Set of 2) | 149 lb |
| 2564 | 48" Tines (Set of 2) | 160 lb |

INDUSTRIAL GRAPPLE

| Cat. # | Description | Approx. Weight |
|--------|------------------------|----------------|
| 1931 | 72" Industrial Grapple | 824 lb |

DOZER BLADE

| Cat. # | Description | Approx. Weight |
|--------|----------------------------------|----------------|
| 2039 | 78" Dozer Blade, Hydraulic Swing | 728 lb |

POST HOLE AUGER

| Cat. # | Description | Approx. Weight |
|--------|--|----------------|
| 2569 | Model PA 40 Auger Drive (Requires Mount & Bit) | 160 lb |
| 1891 | Auger Mount | 126 lb |
| 941 | 9" x 48" Auger Bit w/Serrated Edges | 75 lb |
| 943 | 12" x 48" Auger Bit w/Serrated Edges | 100 lb |
| 119 | 14" x 52" Auger Bit w/Serrated Edges | 105 lb |
| 120 | 16" x 52" Auger Bit w/Serrated Edges | 118 lb |

ANGLE BROOM

| Cat. # | Description | Approx. Weight |
|--------|--|----------------|
| 2188 | 72" Angle Broom (Requires Quick Coupler Kit) | 500 lb |
| 1423 | Quick Coupler Kit | 5 lb |

6. ATTACHMENTS AND BUCKETS

6.1 HYUNDAI APPROVED BUCKETS AND ATTACHMENTS (Continued)

COLD PLANER

| Cat. # | Description | Approx. Weight |
|--------|--------------------------------|----------------|
| 2033 | Cold Planer w/16"-50 Pick Drum | 1700 lb |
| 1811 | Attachment Kit | 50 lb |

BUCKET SWEEPER

| Cat. # | Description | Approx. Weight |
|--------|--|----------------|
| 1306 | 72" Bucket Sweeper Drive (Requires Quick Coupler; Plate; Bucket) | 660 lb |
| 1423 | Quick Coupler Kit | 5 lb |
| 1427 | Backing Plate | 5 lb |
| 1935 | 60" Flat Bottom Utility Bucket | 386 lb |
| 1936 | 73" Utility Bucket | 480 lb |

BUCKET SWEEPER OPTIONS

| Cat. # | Description | Approx. Weight |
|--------|------------------------|----------------|
| 1297 | Gutter Brush | 80 lb |
| 1298 | Water Sprinkler System | 50 lb |

HYDRAULIC BREAKER

| Cat. # | Description | Approx. Weight |
|--------|--|----------------|
| 1537 | HH 300-300 ft. lb. Class Hydraulic Breaker | 300 lb |
| 1579 | HH 500-500 ft. lb. Class Hydraulic Breaker | 400 lb |

BREAKER SIDE PLATES & MOUNTS

| Cat. # | Description | Approx. Weight |
|--------|-------------------------|----------------|
| 1694 | HH300/500 Side Plates | 200 lb |
| 1929 | HH300/500 Breaker Mount | 192 lb |

BREAKER TOOLS

| Cat. # | Description | Approx. Weight |
|--------|-----------------------------|----------------|
| 1533 | Moil Point - HH300 | 25 lb |
| 1534 | Chisel Point - HH300 | 35 lb |
| 1535 | Blunt Point - HH300 | 35 lb |
| 1570 | Asphalt Cutter - HH300 | 41 lb |
| 1571 | Tamping Pad 12 x 12 - HH300 | 105 lb |
| 1580 | Moil Point - HH500 | 40 lb |
| 1581 | Chisel Point - HH500 | 32 lb |
| 1583 | Asphalt Cutter - HH500 | 41 lb |
| 1584 | Tamping Pad 12 x 12 - HH500 | 105 lb |
| 1548 | Gas Charger | 2 lb |

HYDRAULIC SPREADER

| Cat. # | Description | Approx. Weight |
|--------|------------------------------|----------------|
| 1943 | Hydraulic Salt/Sand Spreader | 394 lb |

QUICK-TACH

| Cat. # | Description | Approx. Weight |
|--------|---------------------------|----------------|
| 2326 | Quick-Tachs Complete | |
| 2031 | Quick-Tachs Adapter Plate | 69 lb |

6. ATTACHMENTS AND BUCKETS

6.1 HYUNDAI APPROVED BUCKETS AND ATTACHMENTS (Continued)

XR 911 XTREME REACH BACKHOE

| Cat. # | Description | Approx. Weight |
|---------------|-----------------------------|-----------------------|
| 2194 | XR 911 Xtreme Reach Backhoe | 1860 lb |
| 2203 | 14" Bucket w/Teeth | 106 lb |
| 2201 | 18" Bucket w/Teeth | 126 lb |
| 2197 | 24" Bucket w/Teeth | 146 lb |
| 2199 | 36" Bucket w/Teeth | 195 lb |