

SPECIFICATIONS

1. MAJOR COMPONENT

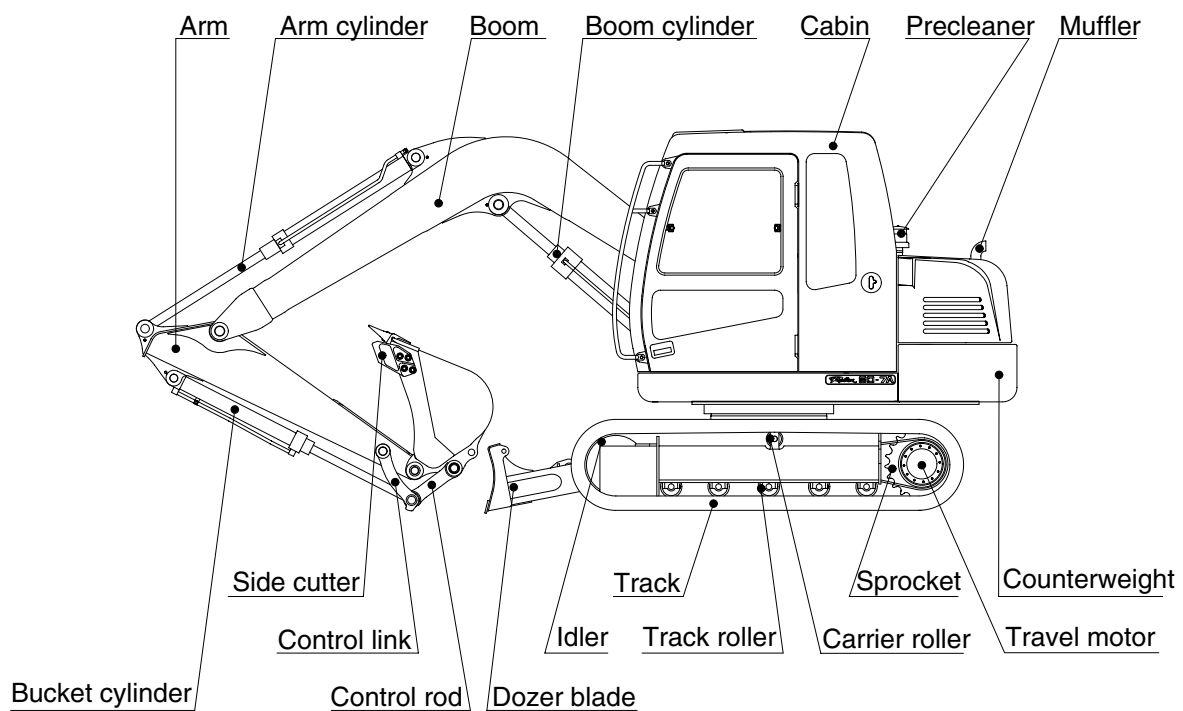
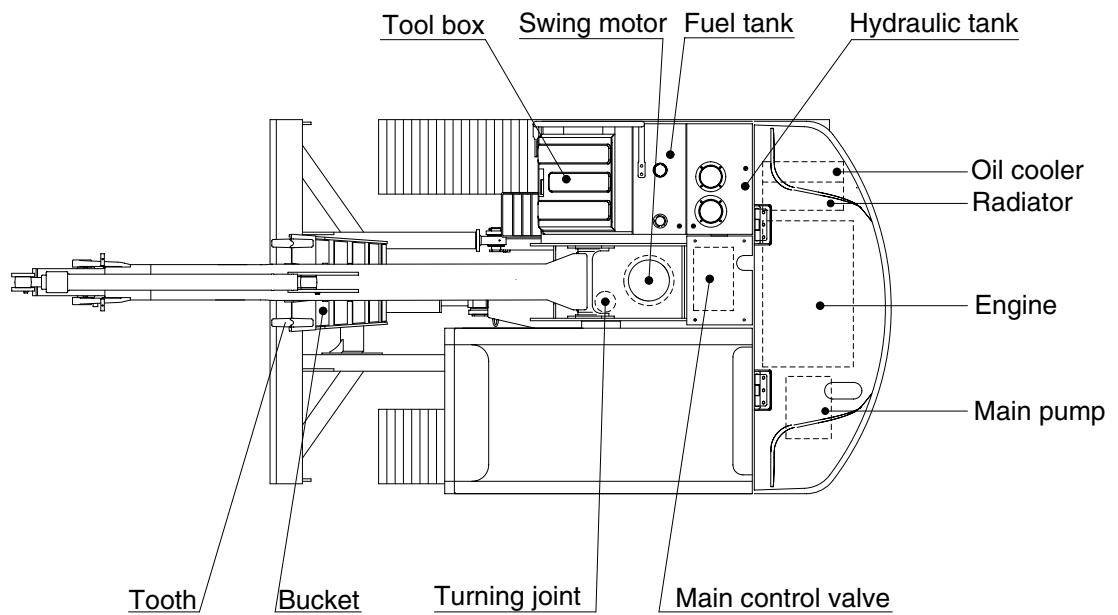

807A2SP01