

6. TRAVELING OF THE MACHINE

1) BASIC OPERATION

(1) Traveling position

It is the position which the traveling motor is in the rear and the working device is forward.

- ▲ **Be careful as the traveling direction will be reversed when the whole machine is swung 180 degree.**

(2) Traveling operation

It is possible to travel by either travel lever or pedal.

- ※ **Do not travel continuously for a long time.**
- ※ **Reduce the engine speed and travel at a low speed when traveling on uneven ground.**

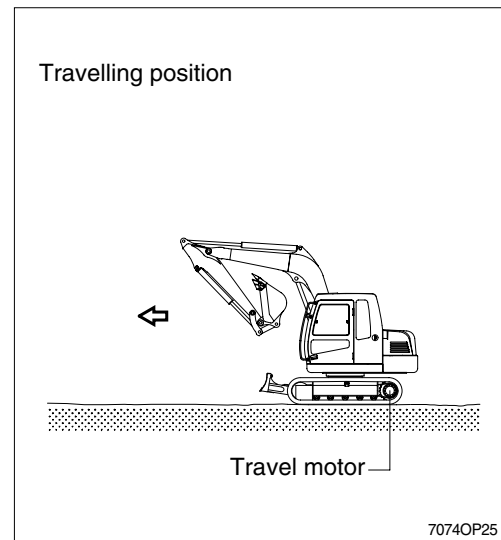

(3) Forward and backward traveling

When the left and right travel lever or pedal are pushed at the same time, the machine will travel forward or backward.

- ※ **The speed can be controlled by the operation stroke of lever or pedal and change of direction will be controlled by difference of the left and right stroke.**

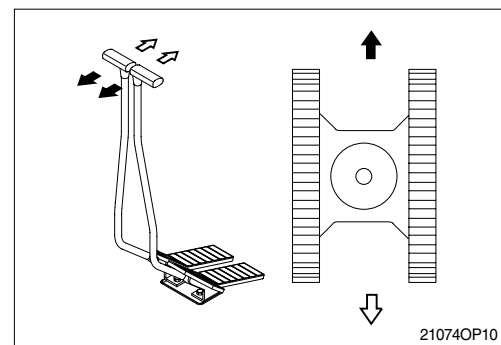

(4) Pivot turning

Operating only one side of lever or pedal make the change of direction possible by moving only one track.

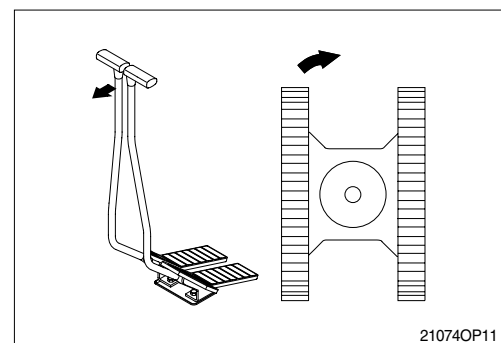

(5) Counter rotation

It is to change the direction at the original place by moving the right and left track. Both side of lever or pedal are operated to the other way at the same time.

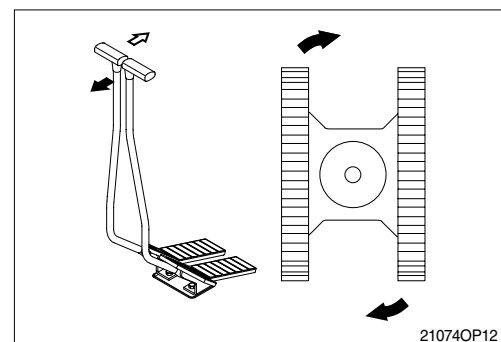

2) TRAVELING ON A SLOPE

- (1) Make sure that the travel lever is properly maneuvered by confirming the travel motor is in the right location.
 - (2) Lower the bucket 20 to 30cm(1ft) to the ground so that it can be used as a brake in an emergency.
 - (3) If the machine starts to slide or loses stability, lower the bucket immediately and brake the machine.
 - (4) When parking on a slope, use the bucket as a brake and place blocks behind the tracks to prevent sliding.
- ※ **Machine cannot travel effectively on a slope when the oil temperature is low. Do the warming-up operation when it is going to travel on a slope.**
- ▲ **Be careful when working on slopes. It may cause the machine to lose its balance and turn over.**
- ▲ **Be sure to keep the travel speed switch on the LOW(Turtle mark) while traveling on a slope.**

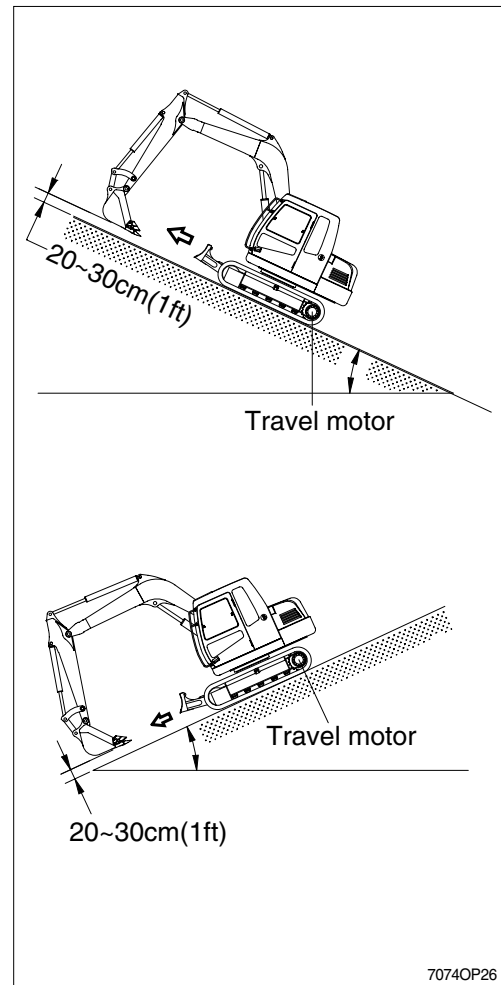

3) TRAVELING ON SOFT GROUND

- ※ **If possible, avoid to operate on soft ground.**
- (1) Move forward as far as machine can move.
 - (2) Take care not to go beyond the depth where towing is impossible on soft ground.
 - (3) When driving becomes impossible, lower bucket and use boom and arm to pull the machine. Operate boom, arm, and travel lever at the same time to avoid the machine sinking.

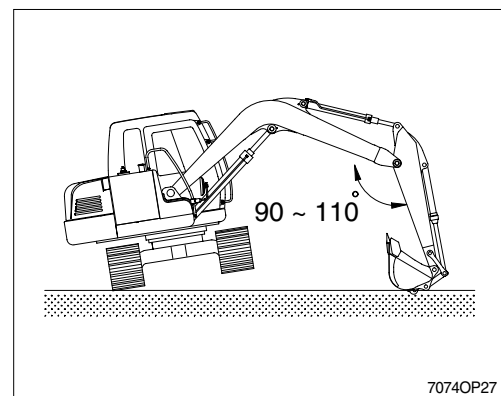

4) TOWING THE MACHINE

Tow the machine as follows when it can not move on it's own.

- (1) Tow the machine by other machine after hook the wire rope to the frame as shown in picture at right.
 - (2) Hook the wire rope to the frame and put a support under each part of wire rope to prevent damage.
- ※ **Never tow the machine using only the tie hole, because this may break.**
 - ▲ **Make sure no personnel are standing close to the tow rope.**

