

## 2. CLUSTER

The cluster consists of gauges and lamps as shown below, to warn the operator in case of abnormal machine operation or conditions for the appropriate operation and inspection.

- Gauges : Indicate operating status of the machine.
- Warning lamp : Indicate abnormality of the machine (red).
- Pilot lamp : Indicate operating status of the machine.

※ **The monitor installed on this machine does not entirely guarantee the condition of the machine. Daily inspection should be performed according to chapter 6, Maintenance.**

※ **When the monitor provides a warning, immediately check the problem and perform the required action.**

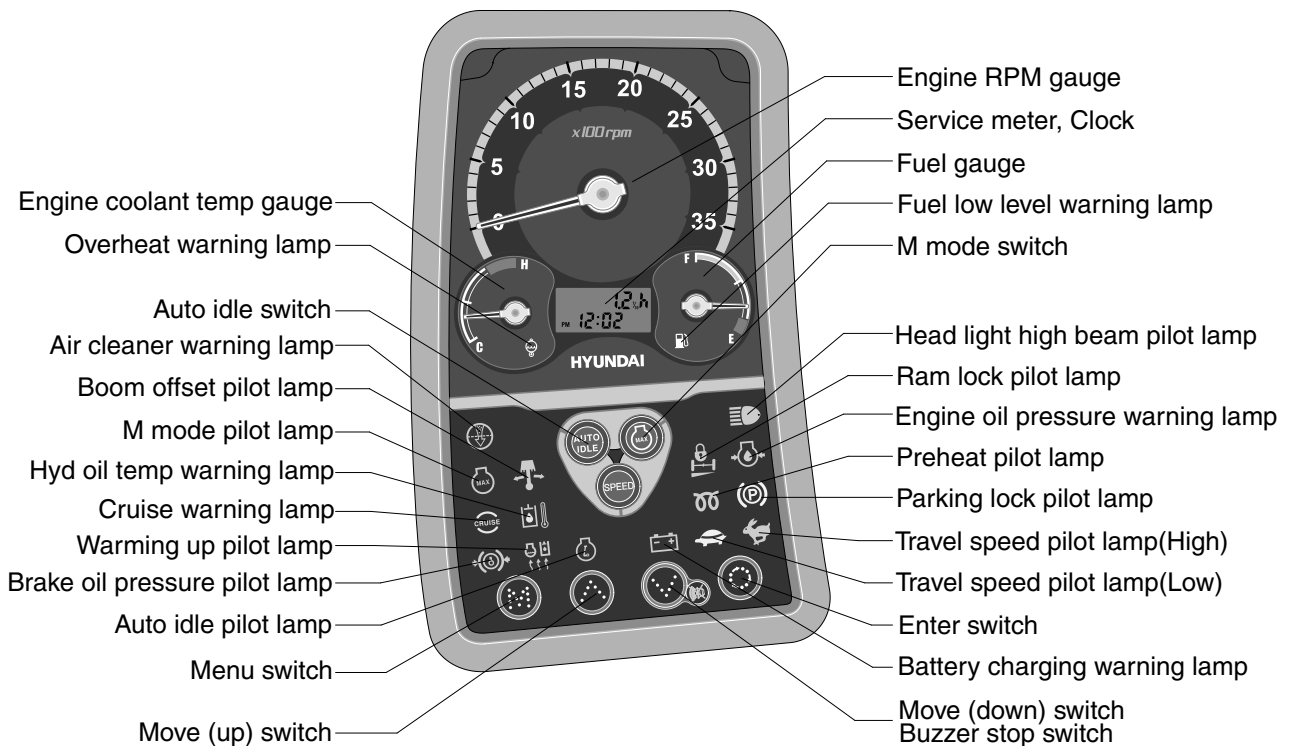

55W93CD02

※ **The warning lamp lights ON and the buzzer sounds when the machine has a problem.**

**In this case, press the buzzer stop switch and buzzer stop, but the warning lamp lights until the problem is cleared.**

## 1) GAUGES AND DISPLAYS

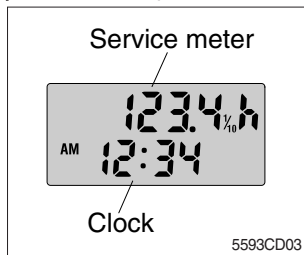

### (1) LCD display

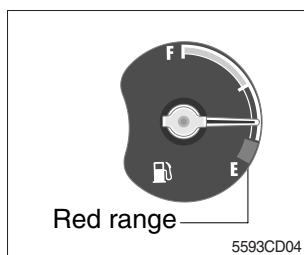

- ① **Service meter** : This meter shows the total operation hours of the machine.
- ※ Always ensure the operating condition of the meter during the machine operation.
  - ※ The last unit  $\frac{4}{10}$  indicates 1/10 of 4 hours.  
(for example :  $\frac{1}{10}$  indicates 6 minutes)
- ② **Clock** : This displays the current time.
- ※ Refer to the "menu switch" for the setting time/ESL switch.

### (2) Fuel gauge



- ① This gauge indicates the amount of fuel in the fuel tank.
- ② Fill the fuel when the red range or warning lamp  blinks.
- ※ **If the gauge indicate the red range or warning lamp  ON. Even though the machine is on the normal condition, check the electric device as that can be caused by the poor connection of electricity or sensor.**

### (3) Engine coolant temperature gauge

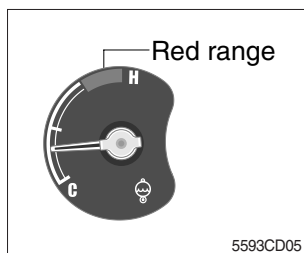

- ① This indicates the temperature of coolant.
- ② When the red range pointed or warning lamp  blinks, engine do not abruptly stop but run it at medium speed to allow it to cool gradually, then stop it.  
Check the radiator and engine.
- ※ **If the engine is stopped without cooled down running, the temperature of engine parts will rise suddenly, this could cause severe engine trouble.**

### (4) Engine rpm gauge

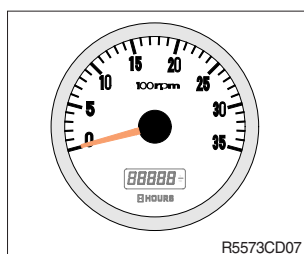

- ① This gauge displays the number of engine revolutions per minute.

## 2) WARNING AND PILOT LAMPS

### (1) Fuel low level warning lamp



- ① This lamp blinks and the buzzer sounds when the level of fuel is below 18 l (4.8 U.S. gal).
- ② Fill the fuel immediately when the lamp blinks.

### (2) Hydraulic oil temperature warning lamp

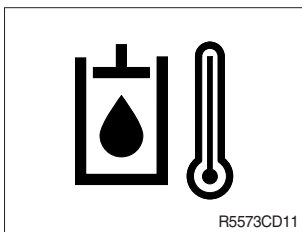

- ① This warning lamp operates and the buzzer sounds when the temperature of hydraulic oil is over 105°C (221°F).
- ② Check the hydraulic oil level when the lamp blinks.
- ③ Check for debris between oil cooler and radiator.

### (3) Overheat warning lamp

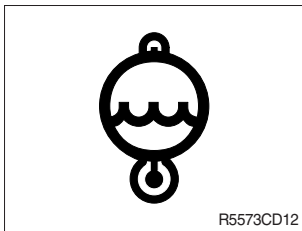

- ① This lamp blinks and the buzzer sounds when the temperature of coolant is over the normal temperature 110°C (230°F).
- ② Check the cooling system when the lamp blinks.

### (4) Engine oil pressure warning lamp

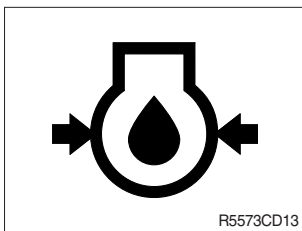

- ① This lamp blinks and the buzzer sounds after starting the engine because of the low oil pressure.
- ② If the lamp blinks during engine operation, shut OFF engine immediately. Check oil level.

### (5) Air cleaner warning lamp

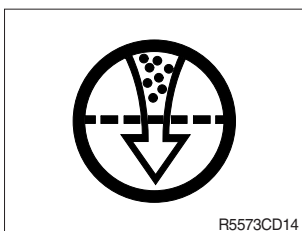

- ① This lamp blinks and the buzzer sounds when the filter of air cleaner is clogged.
- ② Check the filter and clean or replace it.

**(6) Battery charging warning lamp**

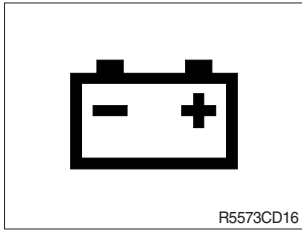

- ① This lamp blinks and the buzzer sounds when the starting switch is ON, it is turned OFF after starting the engine.
- ② Check the battery charging circuit when this lamp blinks during engine operation.

**(7) Warming up pilot lamp**

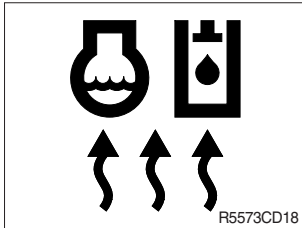

- ① This lamp is turned ON when the coolant temperature is below 30°C (86°F).
- ② The automatic warming up is cancelled when the engine coolant temperature is above 30°C, or when 10 minutes have passed since starting.

**(8) Preheat pilot lamp**

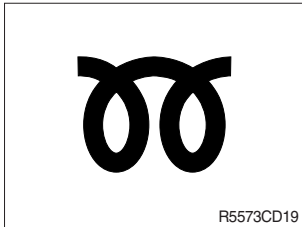

- ① When engine preheating switch is turned ON, pilot lamp comes ON.
- ② Refer to the preheating switch for details.

**(9) Travel speed pilot lamp (high)**

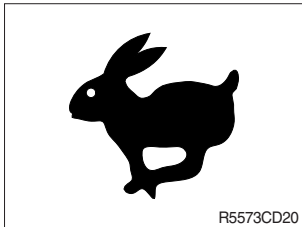

- ① When this lamp turned ON, the machine travel high speed.
- ② Refer to the travel speed select switch for details.

**(10) Travel speed pilot lamp (low)**

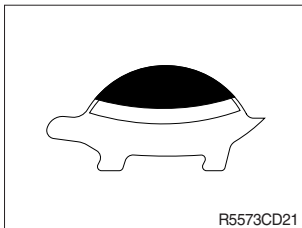

- ① When this lamp turned ON, the machine travel low speed.
- ② Refer to the travel speed select switch for details.

(11) Auto idel pilot lamp

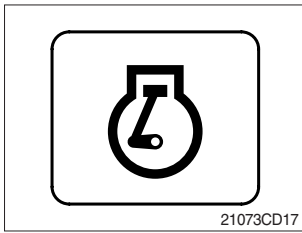

- ① If the control lever and pedal are not moved for several seconds with auto idle switch pressed, the indicator illuminates and engine speed is decelerated.
- ② If the auto idle switch is pressed once more or the control lever or pedal is moved, the indicator turns off and the number of engine revolution is turned to the previous condition.

(12) M mode pilot lamp



- ① This lamp is ON when the M mode switch is pressed.
- ② Engine is operated with a maximum speed.

(13) Boom offset pilot lamp

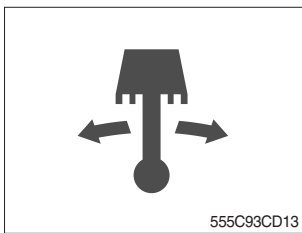

- ① This lamp is ON when the boom offset switch is pressed.

(14) Brake oil pressure warning lamp

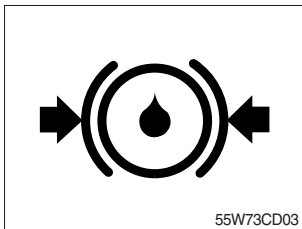

- ① The lamp lights ON when the oil pressure of service brake drops below the normal range.
- ② When the lamp is ON, stop the engine and check for its cause.
- ※ **Do not operate until any problems are corrected.**

(15) Parking lock pilot lamp

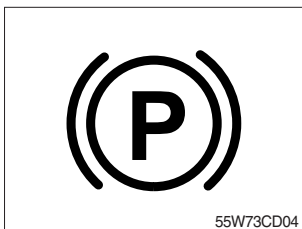

- ① When the parking brake is actuated, the lamp lights ON.
- ※ **Check the lamp is OFF before driving.**

### (16) Ram lock pilot lamp

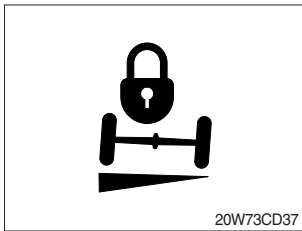

- ① This pilot lamp lights ON when ram lock switch is rear position.
- ② Also, the pilot lamp lights ON when the parking switch is ON or service brake is applied.

### (17) Head light high beam pilot lamp

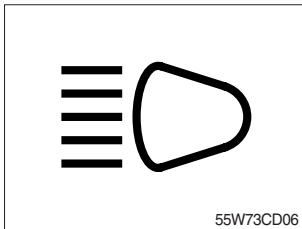

- ① This lamp is ON when the head light switch is high beam position or passing function.
- ② When passing other machines ahead, this lamp must be used for a few seconds to give other machines warning for a few seconds.

### (18) Cruise pilot lamp



- ① When cruise switch is turned ON, pilot lamp comes ON.
- ② Refer to the cruise switch at page 3-16 for details.

### 3) SWITCHES

#### (1) Auto idle switch

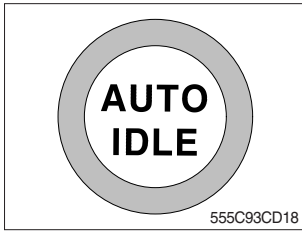

- ① This switch is used to actuate or cancel the auto idle function.
- ② When the switch actuated and all control levers and pedals are at neutral position, engine speed will be lowered automatically to save fuel consumption.

#### (2) M mode switch

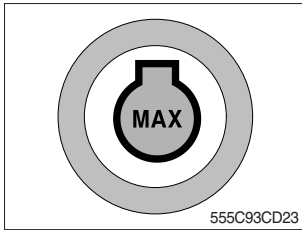

- ① This switch is used to maximum power.
- ② When this switch is pressed, the M mode pilot lamp is ON or OFF.

#### (3) Move (down) & buzzer stop switch

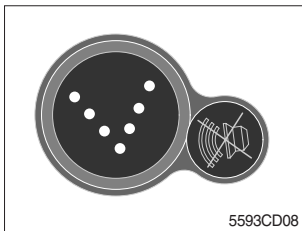

- ① When the starting switch is turned ON first, normally the alarm buzzer sounds for 6 seconds during lamp check operation.
- ② The lamp lights ON and the buzzer sounds when the machine has a problem.  
In this case, press this switch and buzzer stops, but the lamp lights until the problem is cleared.
- ③ This switch is used to move down or decrease input value.  
※ Refer to page 3-9.

#### (4) Move (up) switch

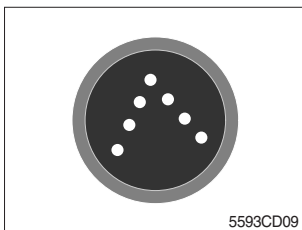

- ① This switch is used to move up or increase input value.  
※ Refer to page 3-9.

## (5) Menu and enter switch

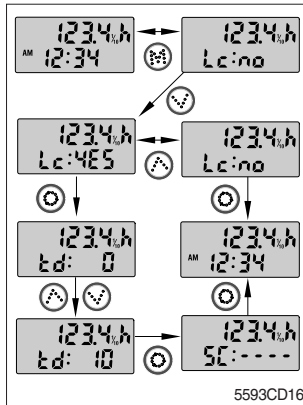
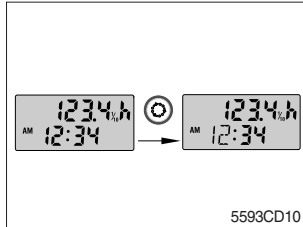
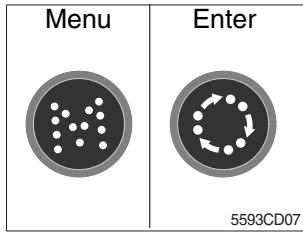

① These switches are used to set time or set ESL (Engine Start Limit) function.

- The Enter button (⊙) is used to select a function.
- The Menu button (⊗) is used to select a menu or return to the time display menu.

### ② Setting time

- Press Enter button (⊙) to set time, then the screen will be changed to a display for time setting as a following picture and time cipher will blink.
- **Set hours** : When the cipher for hour blinks, press up (⬆) or down (⬇) button and set the hour.
- **Set minutes**: When the cipher for minute blinks, press up (⬆) or down (⬇) button and set the minute.

### ③ Set ESL (Engine Start Limit) function

- Press Menu button (⊗), the display is changed from the time display menu to ESL function menu.
- Select YES or NO by Move button (⬆, ⬇) and set the ESL function by the Enter button (⊙).
  - YES : ESL function is activated.
  - NO : ESL function is cancelled.

### ④ Set the interval time

- Select ESL function to YES and press the Enter button (⊙), then the display is changed to the interval time set menu.
- Set the interval time by move button (⬆, ⬇) and press the Enter button (⊙).
- You can finish setting the interval time by inputting the password and pressing the Enter button (⊙) once more.
- Interval times : 5 kinds (0, 10, 30, 60 minutes, 1day)
- ※ **If the ESL function is set to YES, the password is required when a operator starting engine first.**  
**But the operator can restart the engine within the interval time period without inputting the password.**

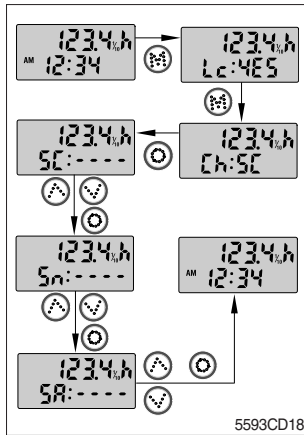

### ⑤ Change password

- Select ESL function to YES and press the Menu button (⊗), the display is shifted to the password change menu.
- Input a new password (Sn : - - - -) after enter the current password successfully (SC : - - - -).
- Push enter (⊗) button for a second to finish the setting after the new password is entered once again (SA : - - - -).
- When the setting is done, the display will blink 3 times and return to the time display screen.

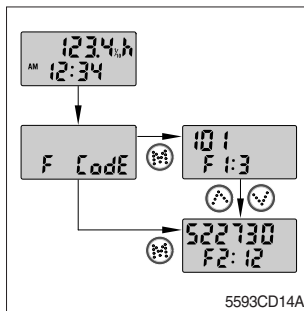

### ⑥ Check machine and engine diagnostic codes

- If the F : Code is displayed on the LCD display, you can check faults of the machine and/or engine.
- The machine fault code is displayed by pressing the Menu button (⊗) and the engine fault code is displayed by pressing the Menu button (⊗) once more.
- Other fault codes can be displayed by using the Move up / down button (⬆, ⬇).

※ Refer to the following pages for the fault codes.

## ⑦ Machine fault code

Fault code		Description
HCESPN	FMI	
105	0	Working pressure sensor data above normal range (or open circuit)
	1	Working pressure sensor data below normal range
	2	Working pressure sensor data error
	4	Working pressure sensor circuit - voltage below normal, or shorted to low source
	14	Working pressure sensor circuit - special instructions
	16	Working pressure sensor circuit - voltage valid but above normal operational range
	18	Working pressure sensor circuit - voltage valid but below normal operational range
167	4	Travel speed solenoid circuit - voltage below normal, or shorted to low source (or open circuit)
	6	Travel speed solenoid circuit - current above normal
503	0	Brake pressure sensor data above normal range (or open circuit)
	1	Brake pressure sensor data below normal range
	2	Brake pressure sensor data error
	4	Brake pressure sensor data - voltage below normal, or shorted to low source
	16	Brake pressure sensor data - voltage valid but above normal operational range
	18	Brake pressure sensor data - voltage valid but below normal operational range
505	0	Working brake pressure sensor data above normal range (or open circuit)
	1	Working brake pressure sensor data below normal range
	2	Working brake pressure sensor data error
	4	Working brake pressure sensor circuit - voltage below normal, or shorted to low source
	16	Working brake pressure sensor circuit - voltage valid but above normal operational range
	18	Working brake pressure sensor circuit - voltage valid but below normal operational range
525	4	Ram lock solenoid circuit - voltage below normal, or shorted to low source (or open circuit)
	6	Ram lock solenoid circuit - current above normal
530	0	Travel fwd pilot pressure sensor data above normal range (or open circuit)
	1	Travel fwd pilot pressure sensor data below normal range
	2	Travel fwd pilot pressure sensor data error
	4	Travel fwd pilot pressure sensor circuit - voltage below normal, or shorted to low source
	14	Travel fwd pilot pressure sensor circuit - special instructions
	16	Travel fwd pilot pressure sensor circuit - voltage valid but above normal operational range
	18	Travel fwd pilot pressure sensor circuit - voltage valid but below normal operational range
701	4	Hour meter circuit - voltage below normal, or shorted to low source
705	0	MCU input voltage high
	1	MCU input voltage low
707	1	Alternator node I voltage low (or open circuit)
714	3	Acc. dial circuit - voltage above normal, or shorted to high source (or open circuit)
	4	Acc. dial circuit - voltage below normal, or shorted to low source
830	12	MCU internal memory error
840	2	Cluster communication data error
841	2	ECM communication data error
850	2	RMCU communication data error

### ⑧ Engine fault code

Fault code		Description
YANMAR SPN	FMI	
1210	4	Engine fuel rack position sensor : shorted to low source
	3	Engine fuel rack position sensor : shorted to high source
91	4	Accelerator pedal position sensor "A" : shorted to low source
	3	Accelerator pedal position sensor "A" : shorted to high source
	2	Accelerator pedal position sensor "A" : intermittent fault
	1	Accelerator pedal position sensor "A" : below normal operational range (SAE J1843)
	0	Accelerator pedal position sensor "A" : above normal operational range (SAE J1843)
	15	Accelerator pedal position sensor "A" : not available (SAE J1843)
29	4	Accelerator pedal position sensor "B" : shorted to low source
	3	Accelerator pedal position sensor "B" : shorted to high source
	2	Accelerator pedal position sensor "B" : intermittent fault
	1	Accelerator pedal position sensor "B" : below normal operational range (SAE J1843)
	0	Accelerator pedal position sensor "B" : above normal operational range (SAE J1843)
	8	Accelerator pedal position sensor "B" : communication fault
	15	Accelerator pedal position sensor "B" : not available (SAE J1843)
108	4	Barometric pressure sensor : shorted to low source
	3	Barometric pressure sensor : shorted to high source
	2	Barometric pressure sensor : intermittent fault
1136	4	E-ECU internal temperature sensor : shorted to low source
	3	E-ECU internal temperature sensor : shorted to high source
	2	E-ECU internal temperature sensor : intermittent fault
	0	E-ECU internal temperature : too high
110	4	Engine coolant temperature sensor : shorted to low source
	3	Engine coolant temperature sensor : shorted to high source
	2	Engine coolant temperature sensor : intermittent fault
	0	Engine coolant temperature : too high
1079	4	Sensor 5V : shorted to low source
	3	Sensor 5V : shorted to high source
	2	Sensor 5V : intermittent fault
158	1	E-ECU system voltage : too low
	0	E-ECU system voltage : too high
1078	4	Engine fuel injection pump speed sensor : shorted to low source
522402	4	Auxiliary speed sensor : shorted to low source
522241	4	Engine fuel rack actuator relay : open circuit
	3	Engine fuel rack actuator relay : short circuit
	7	Engine fuel rack actuator relay : mechanical malfunction
	2	Engine fuel rack actuator relay : intermittent fault
522243	4	Air heater relay : open circuit
	3	Air heater relay : short circuit
	2	Air heater relay : intermittent fault

Fault code		Description
YANMAR SPN	FMI	
522242	4	Cold start device : open circuit
	3	Cold start device : short circuit
	2	Cold start device : intermittent fault
522251	4	EGR stepping motor "A" : open circuit
	3	EGR stepping motor "A" : short circuit
522252	4	EGR stepping motor "B" : open circuit
	3	EGR stepping motor "B" : short circuit
522253	4	EGR stepping motor "C" : open circuit
	3	EGR stepping motor "C" : short circuit
522254	4	EGR stepping motor "D" : open circuit
	3	EGR stepping motor "D" : short circuit
100	4	Oil pressure switch : shorted to low source
	1	Oil pressure : too low
167	4	Battery charge switch : shorted to low source
	1	Battery charge : charge warning
522314	0	Engine coolant temperature : abnormal temperature
522323	0	Air cleaner : mechanical malfunction
522329	0	Oily water separator : mechanical malfunction
190	0	Engine speed : over speed condition
638	4	Engine fuel rack actuator : shorted to low source
	3	Engine fuel rack actuator : shorted to high source
	7	Engine fuel rack actuator : mechanical malfunction
639	12	High speed CAN communication : communication fault
630	2	E-ECU internal fault : EEPROM check sum error (data set 2)
	12	E-ECU internal fault : EEPROM error
628	12	E-ECU internal fault : flashROM check sum error (main software)
	2	E-ECU internal fault : flashROM check sum error (data set 1)
	2	E-ECU internal fault : flashROM check sum error (data set 2)
1485	4	E-ECU main relay : shorted to low source
522727	12	E-ECU internal fault : cyclic redundancy check of sub-CPU error
	12	E-ECU internal fault : acknowledgement of sub-CPU error
	12	E-ECU internal fault : communication with sub-CPU error
522728	12	E-ECU internal fault : engine map data version error
522730	12	Immobilizer : CAN communication fault
	8	Immobilizer : pulse communication fault
1202	2	Immobilizer : system fault