

SPECIFICATIONS

1. MAJOR COMPONENTS

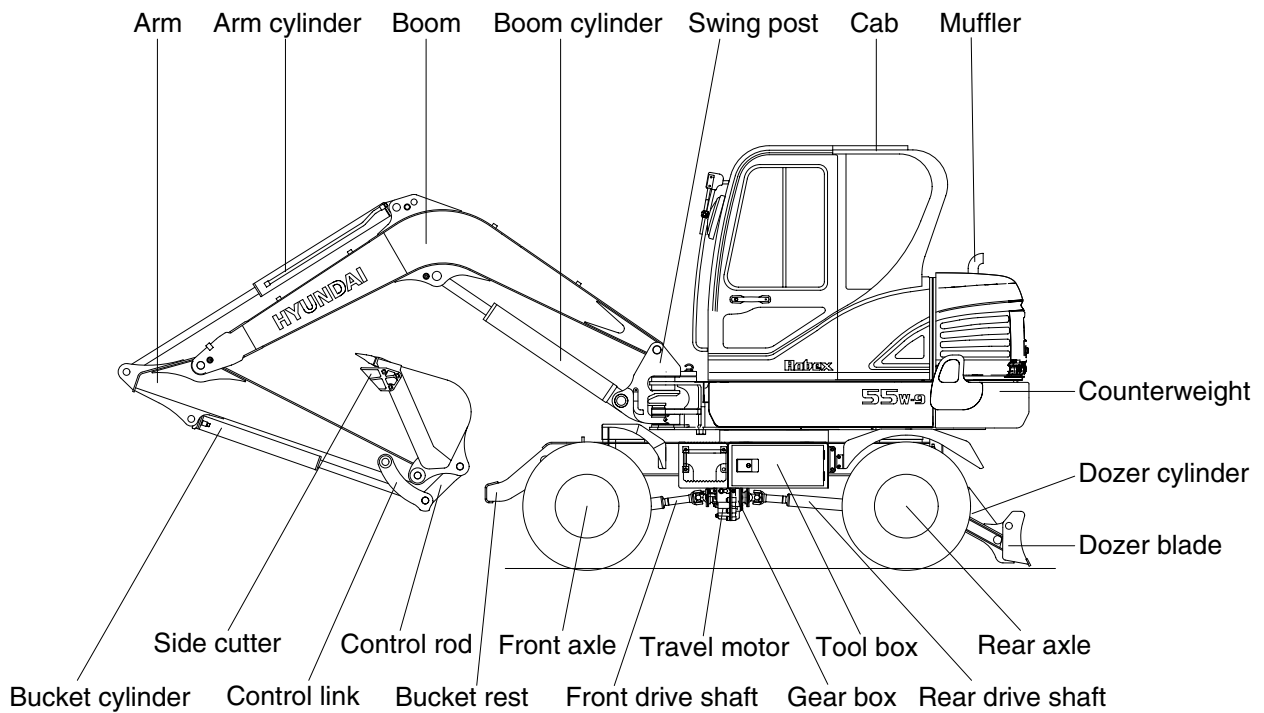
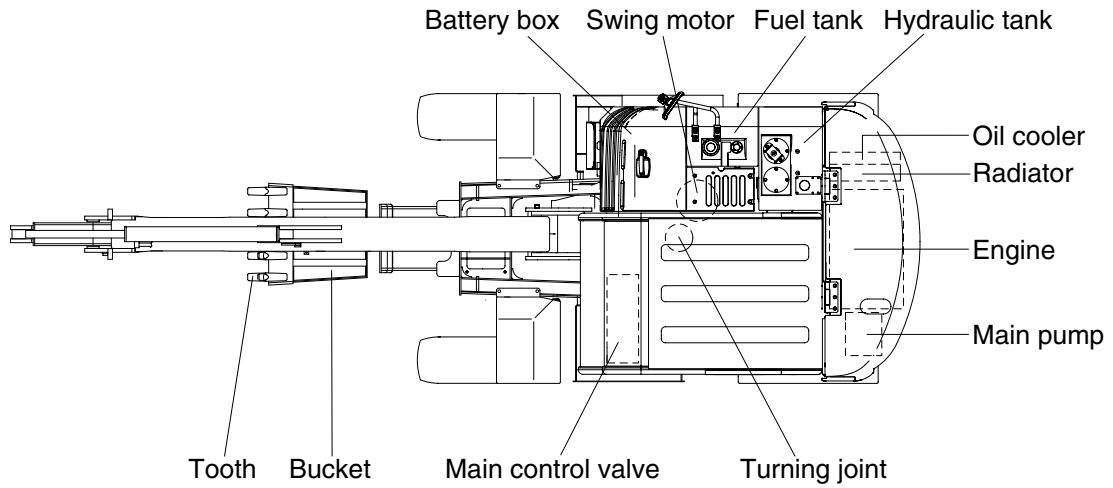

55W92SP01