

## 7. OPERATION IN THE SPECIAL WORK SITES

### 1) OPERATION THE MACHINE IN A COLD WEATHER

- (1) Use proper engine oil and fuel for the weather.
- (2) Fill the required amount of antifreeze in the coolant.
- (3) Refer to the starting engine in cold weather.  
Start the engine and extend the warming up operation.
- (4) Be sure to open the heater cock when using the heater.
- (5) Always keep the battery completely charged.  
※ **Discharged batteries will freeze more easily than fully charged.**
- (6) Clean the machine and park on the wood plates.

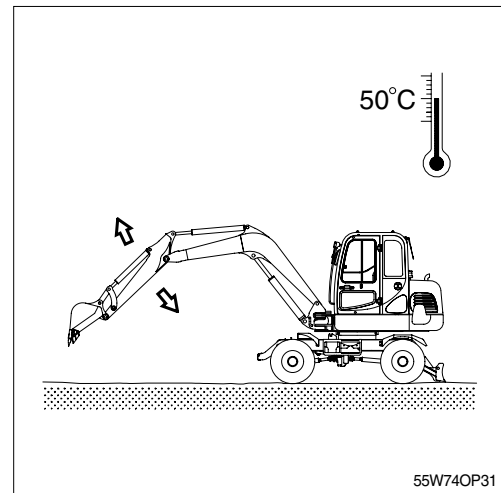

### 2) OPERATION IN SANDY OR DUSTY WORK SITES

- (1) Inspect air cleaner element frequently. Clean or replace element more frequently, if warning lamp comes ON and buzzer sounds simultaneously, regardless of inspection period.  
※ **Replace the inner and outer element after 6 times of cleaning.**
- (2) Inspect radiator frequently, and keep cooling fins clean.
- (3) Prevent sand or dust from getting into fuel tank and hydraulic tank during refilling.
- (4) Prevent sand or dust from penetrating into hydraulic circuit by tightly closing breather cap of hydraulic oil tank. Replace hydraulic oil filter frequently.
- (5) Keep all lubricated part, such as pins and bushings, clean at all times.
- (6) If the air conditioner and heater filters clogged, the heating or cooling capacity will drop. Clean or replace the filter element more frequently.

### 3) SEA SHORE OPERATION

- (1) Prevent ingress of salt by securely tightening plugs, cocks and bolts of each part.
- (2) Wash machine after operation to remove salt residue.  
Pay special attention to electrical parts and hydraulic cylinders to prevent corrosion.
- (3) Inspection and lubrication must be carried out more frequently.  
Supply sufficient grease to replace all old grease in bearings which have been submerged in water for a long time.

