

10. STORAGE

Maintain the machine taking care of following to prevent the deterioration of machine when storing the machine for a long time, over 1 month.

1) CLEANING THE MACHINE

Clean the machine. Check and adjust tracks.
Grease each lubrication part.

2) LUBRICATION POSITION OF EACH PART

Change all oil.

※ Be particularly careful when you reuse the machine.

As oil can be diluted during storage.

Apply an anticorrosive lubricant on the exposed part of piston rod of cylinder and in places where the machine rusts easily.

3) MASTER SWITCH

Turn OFF the master switch mounted electric box and store the machine.

4) Be sure to mix anticorrosive antifreezing solution in the radiator.

5) PREVENTION OF DUST AND MOISTURE

Keep machine dry. Store the machine setting wood on the ground.

※ Cover exposed part of piston rod of cylinder.

※ Lower the bucket to the ground and set a support under track.

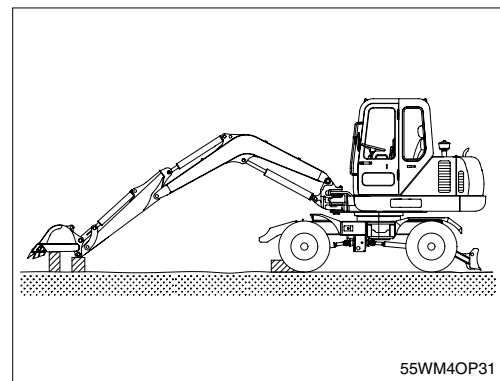
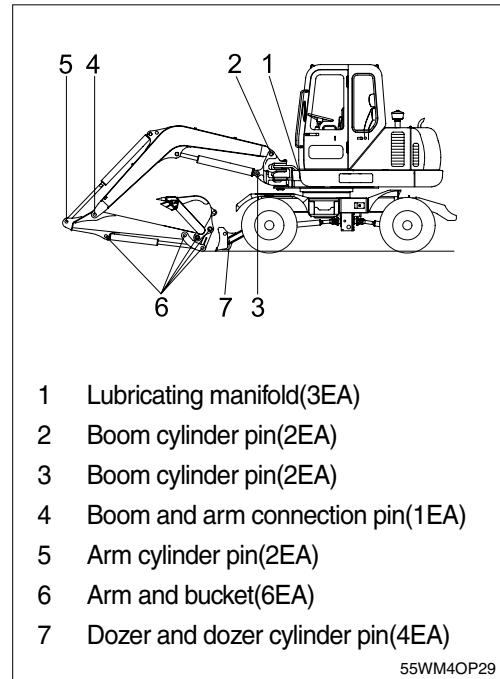

6) DURING STORAGE

Start engine and move the machine and work equipment once a month and apply lubrication to each part.

- ※ Check the level of engine oil and coolant and fill if required when starting engine.
- ※ Clean the anticorrosive on the piston rod of cylinder.
- ※ Operate the machine such as traveling, swing and work equipment operation to make sure enough lubrication of all functional components.

