

4. FIXING THE MACHINE

- 1) Lower down the working device on the loading plate of trailer.
- 2) Keep the safety lever on the LOCK position.
- 3) Turn OFF all the switches and remove the key.

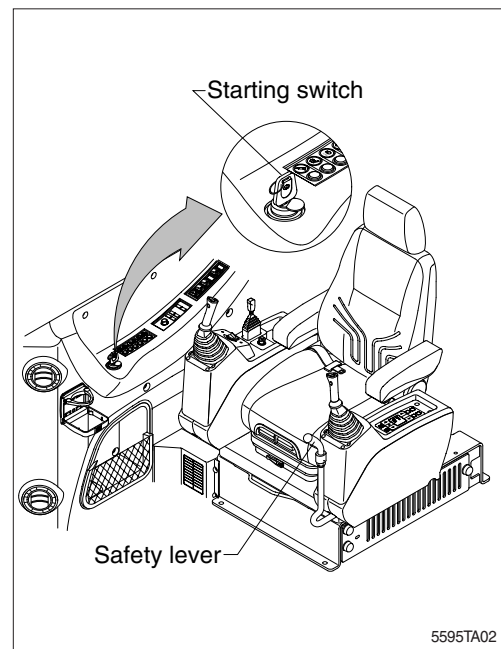

- 5) Secure all locks.

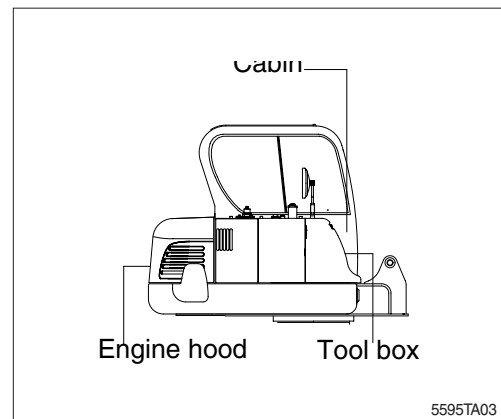

- 6) Place timber underneath of the track and fix firmly with wire rope to prevent the machine from moving forward, backward, right or left.

