

# SAFETY HINTS

## 1. BEFORE OPERATING THE MACHINE

Think-safety first.

In special situation, wear protective clothing including a safety helmet, safety shoes, gloves, safety glasses and ear protection as required by the job condition.

Almost every accident is caused by disregarding the simple and fundamental safety hints.

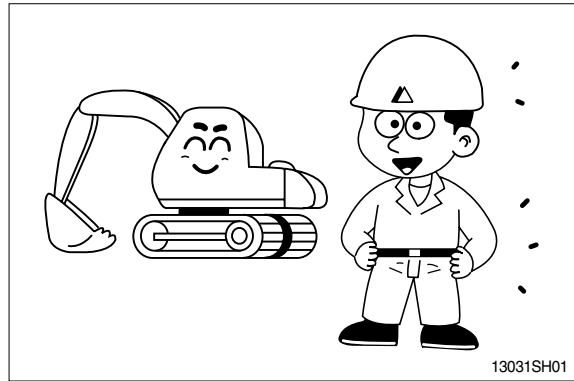

Be sure to understand thoroughly all about the operator's manual before operating the machine.

Proper care is your responsibility.

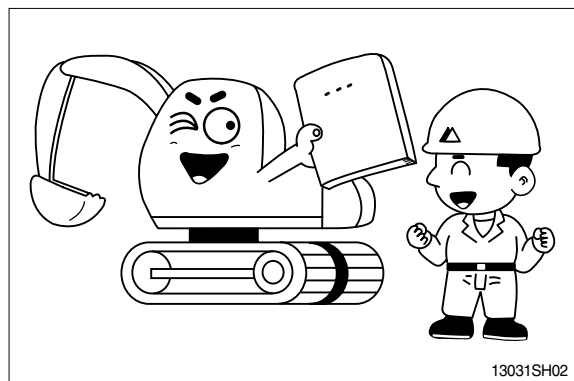

Fully understand the details and process of the construction before starting the work.

If you find anything dangerous on the job, consult with the job supervisor for the preventive measures before operating the machine.

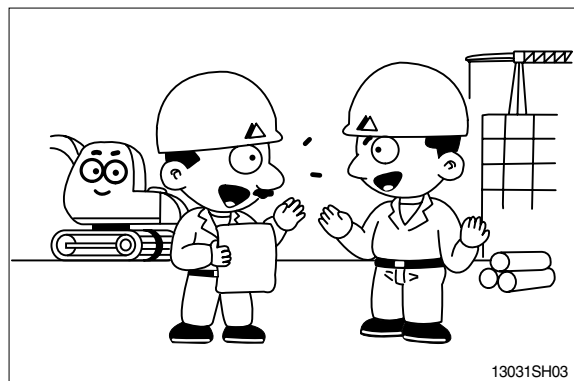

Do not operate when tired, or after drinking alcoholic beverages or any type of drugs.

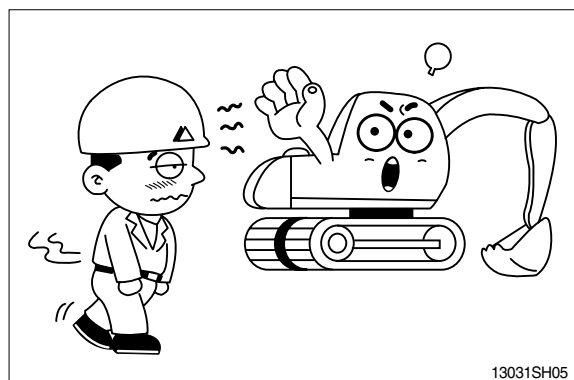

Check daily according to the operation manual.  
Repair the damaged parts and tighten the loosened bolts.

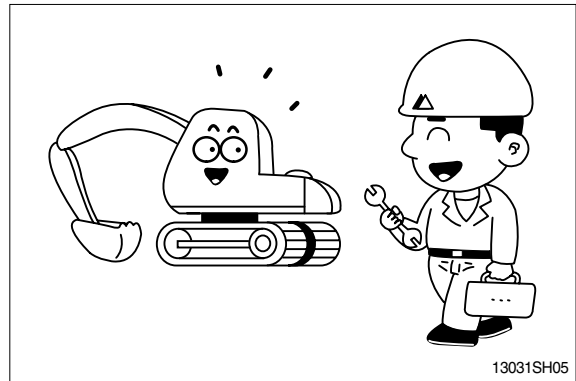

Check for leakage of engine oil, hydraulic oil,  
fuel and coolant.  
Keep machine clean, clean machine regularly.

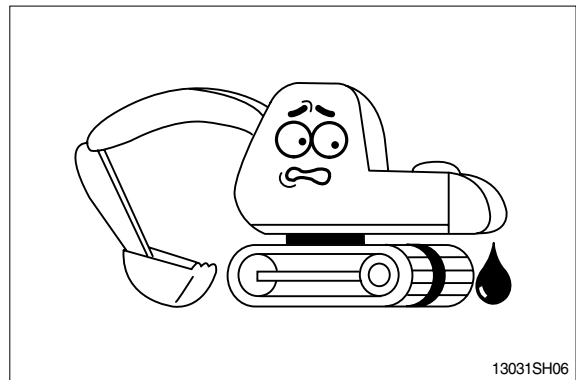

Do not operate the machine if it requires repairs.  
Operate after complete repair.

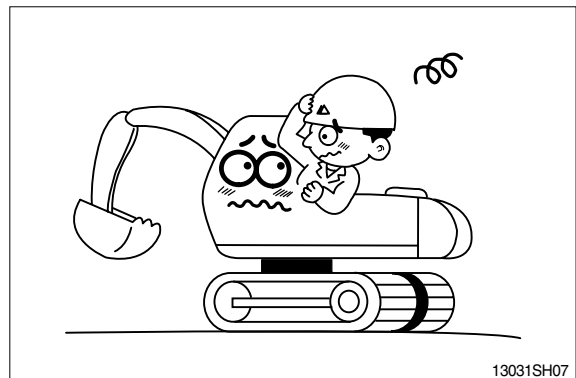

Be prepared if a fire starts.  
Keep a fire extinguisher handy and emergency  
numbers for a fire department near your  
telephone.

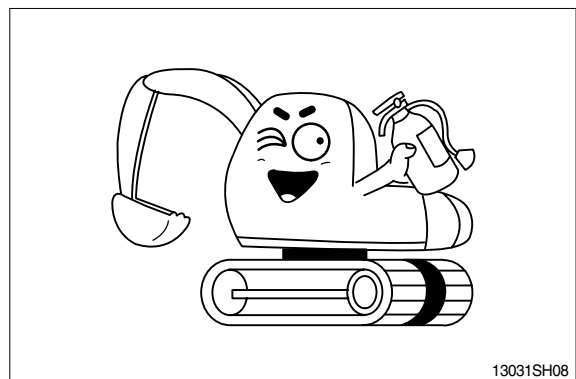

## UNAUTHORIZED MODIFICATION

Any modification made without authorization from Hyundai can create hazards.

Before making a modification, consult your Hyundai distributor. Hyundai will not be responsible for any injury or damage caused by any unauthorized modification.



## PREPARE FOR EMERGENCY

Only in case of emergency, use the installed hammer for breaking the windshield of the cab, and then exit carefully.

Have a fire extinguisher and first aid kit ready for emergencies such as fires or accidents.

Learn how to use the fire extinguisher.

Be sure you know the phone numbers of persons you should contact in case of an emergency.

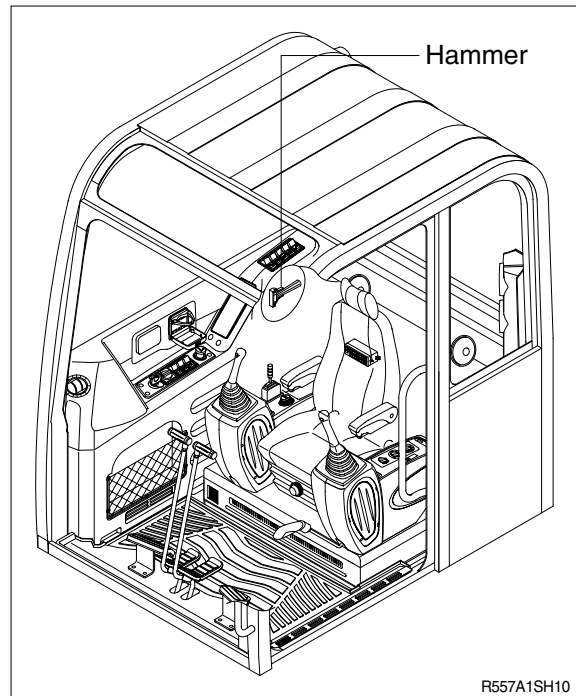

## ROTATING BEACON

When you operate a machine on a road or beside a road, a rotating beacon is required to avoid any traffic accident.

Please contact your Hyundai distributor to install it.

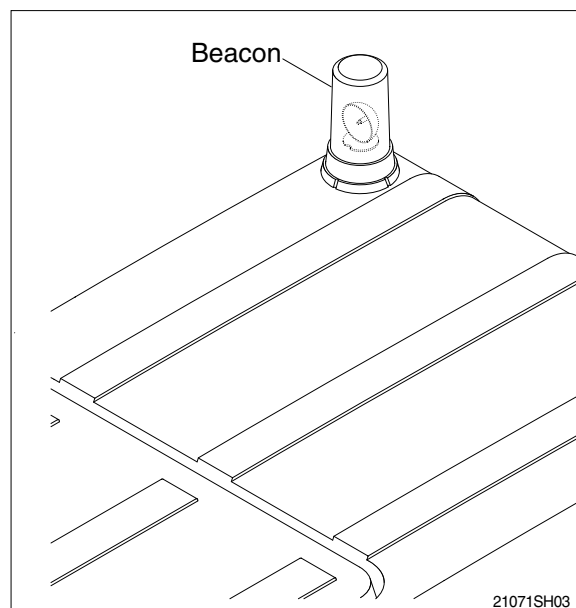

## PRECAUTIONS FOR ATTACHMENTS

When installing and using an optional attachment, read the instruction manual for the attachment and the information related to attachments in this manual.

Do not use attachments that are not authorized by Hyundai or your Hyundai distributor. Use of unauthorized attachments could create a safety problem and adversely affect the proper operation and useful life of the machine.

Any injuries, accidents, product failures resulting from the use of unauthorized attachments are not the responsibility of Hyundai.

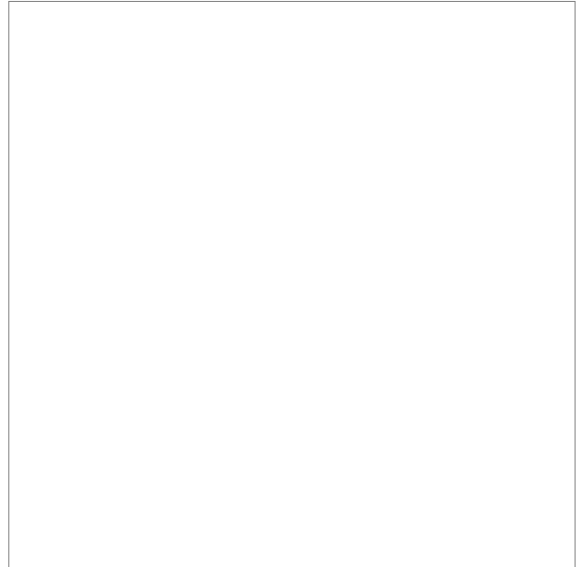

## SAFETY RULES

**Only** trained and authorized personnel can operate and maintain the machine.

Follow all safety rules, precautions and instructions when operating or performing maintenance on the machine.

When working with another operator or a person on worksite traffic duty, be sure all personnel understand all hand signals that are to be used.

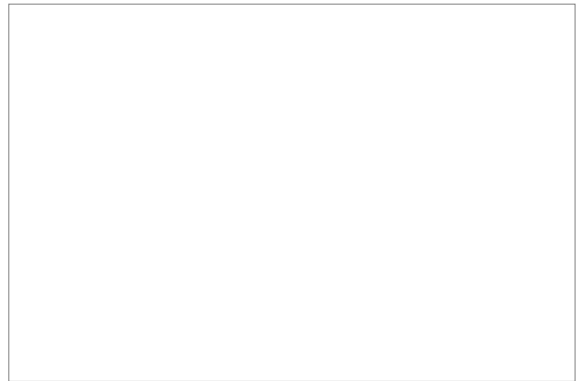

## SAFETY FEATURES

Be sure all guards and covers are in their proper position. Have guards and covers repaired if damaged.

Use safety features such as safety lock and seat belts properly.

**Never** remove any safety features. **Always** keep them in good operating condition.

Improper use of safety features could result in serious bodily injury or death.

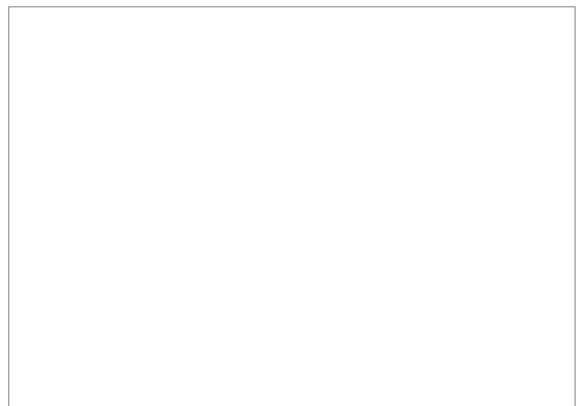

## MACHINE CONTROL PATTERN

Check machine control pattern for conformance to pattern on label in cab.

If not, change label to match pattern before operating machine.

Failure to do so could result in injury.

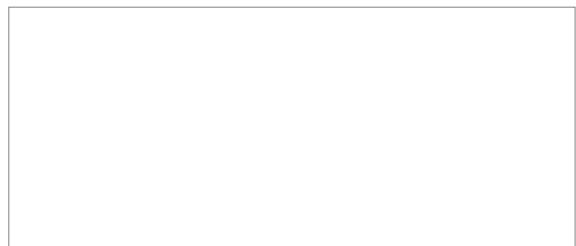

## CALIFORNIA PROPOSITION 65

Diesel engine exhaust and some of its constituents are known to the State of California to cause cancer, birth defects and other reproductive harm.

This product contains or emits chemicals known to the State of California to cause cancer or birth defects or other reproductive harm.

Battery posts, terminals and related accessories contain lead and lead compounds.

**WASH HANDS AFTER HANDLING**



13031SH55

Do not load the machine with the lifting eyes on the counterweight.

**▲** The wrong loading method can result in serious bodily injury or death.

