

# HYDRAULIC BREAKER

## 1. SELECTING HYDRAULIC BREAKER

- 1) Become familiar with the manual and select breakers suitable to machine specifications.
- 2) Make careful selection in consideration of oil quantity, pressure and striking force, to enable satisfied performance.
- 3) When apply a breaker to the machine, consult your local dealer of Hyundai for further explanation.

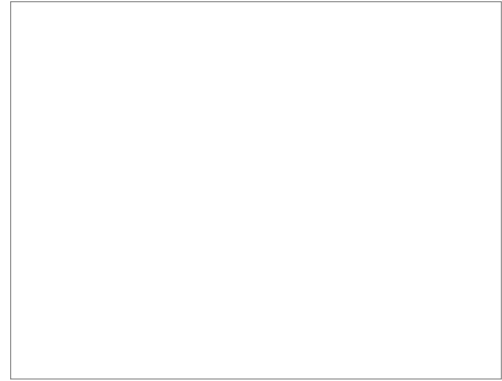

## 2. CIRCUIT CONFIGURATION

- 1) As for breaker oil pressure line, use extra spool of main control valve.
- 2) Set proper breaker pressure on load relief valve.
- 3) The pressure of the ROBEX500LC-7A system is 330kgf/cm<sup>2</sup>(4700psi).



### 4) Adjusting oil quantity

- (1) Use the breaker mode from work mode. Default oil flow quantity is 306lpm at 1800rpm. Use accel dial switch to control the oil flow quantity.
- (2) If the quantity of hydraulic oil is not controlled properly, it causes short lifecycle of the breaker and the machine by increased breaking force and count.

Oil quantity according to engine rpm

Engine rpm	Oil flow l/min	Oil flow U.S.gpm
1700	289	76.4
1600	272	71.9
1500	255	67.4
1400	238	62.9

※ Relief pressure : 200kgf/cm<sup>2</sup>

- 5) The accumulator should be used to the breaker charging and return line.  
If the accumulator is not used, it will be damage as the input wave is delivered.  
※ **Keep the pressure pulsation of pump below 60kgf/cm<sup>2</sup>(853psi) by installing the accumulator.**
- 6) Do not connect the breaker return line to the main control, but connect to the return line front of the cooler.
- 7) Do not connect the breaker return line to drain lines, such as of swing motor, travel motor or pump, otherwise they should be damaged.
- 8) One of spool of the main control valve should be connected to the tank.
- 9) Select the size of pipe laying considering the back pressure.
- 10) Shimless tube should be used for the piping. The hose and seal should be used Hyundai genuine parts.
- 11) Weld the bracket for pipe clamp to prevent damage caused by vibration.

### 3. MAINTENANCE

#### 1) MAINTENANCE OF HYDRAULIC OIL AND FILTER

- (1) As machine with an hydraulic breaker provides the hydraulic oil becomes severely contaminated.
- (2) So, unless frequently maintained, the machine may easily go out of order.
- (3) Inspect and maintain hydraulic oil and 4 kinds of filter elements in particular, in order to prolong machine life.
- (4) Replace when the breaker work is used for short time according to the standard of right graph.

#### 2) RELEASE THE PRESSURE IN BREAKER CIRCUIT

When breaker operating is finished, stop engine and push pedal or switch for breaker to release pressure in breaker circuit.

If pressure still remains, the lifetime of the diaphragm in the accumulator will be shortened.

- 3) Be careful to prevent contamination by dust, sand and etc.  
If such pollution become mixed into the oil, the pump moving parts will wear abnormally, shorten lifetime and become damaged.
- 4) When operating breaker, bolts and nuts of main equipment may be loosened by vibration. So, it must be inspected periodically.

Service interval unit : hours

Attachment	Operating rate	Hydraulic oil	Filter element
Bucket	100%	2,000	250
Breaker	100%	600	100

- **Replace following filter same time**
  - Hydraulic return filter : 1EA
  - Pilot line filter : 1EA
  - Element in hydraulic tank breather : 1EA
  - Drain filter cartridge : 1EA

Filter replace guide for hydraulic breaker

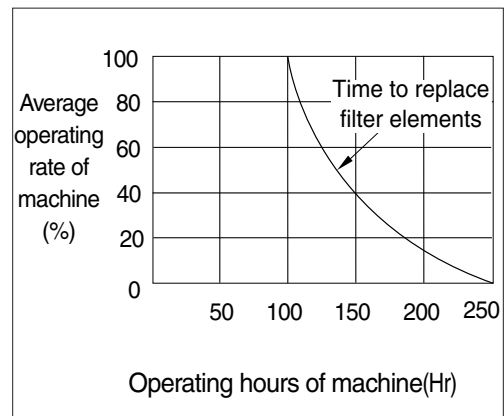

Oil change guide for hydraulic breaker

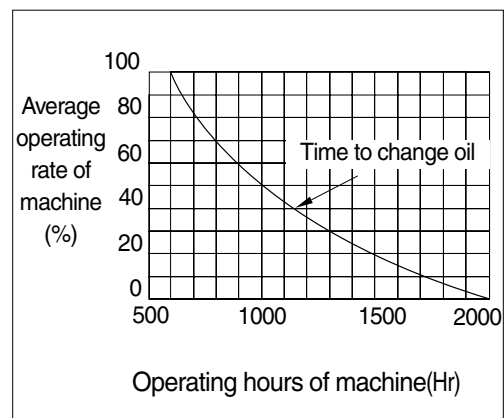

## 4. PRECAUTIONS WHILE OPERATING THE BREAKER

### 1) DO NOT BREAK ROCK WHILE LOWERING

As the breaker is heavy in comparison with bucket, it must be operated slowly.

If breaker is rapidly pushed down, working device may be damaged.

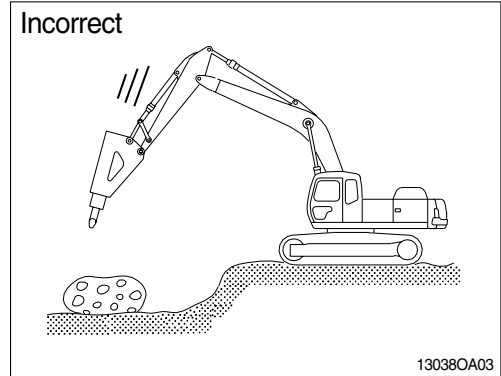

### 2) DO NOT USE BREAKER TO CARRY BROKEN STONE OR ROCK BY SWING OPERATING

This may damage the operation device and swing system.

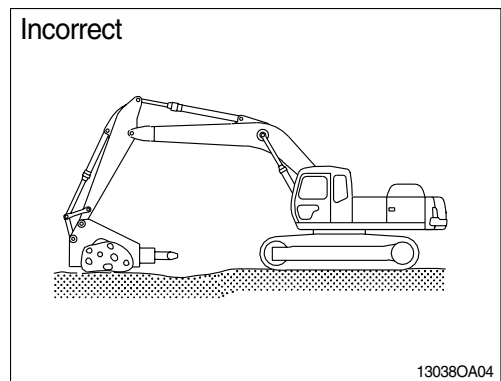

### 3) OPERATE BREAKER WITH A GAP IN EXCESS OF 100mm(4 inches) FROM THE END OF THE STROKE TIP

If breaker is operated with the end tip, the cylinder may be damaged.

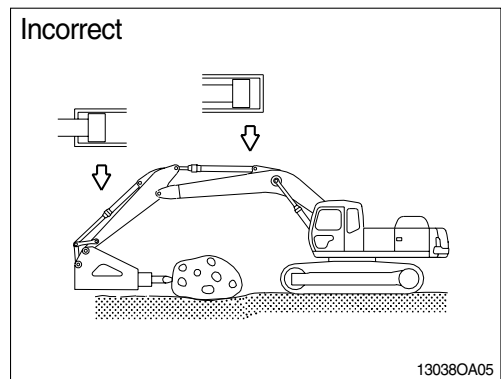

### 4) IF THE HYDRAULIC HOSES VIBRATE EXCESSIVELY

If the machine used in this condition continuously this will effect badly on the machine such as loosening bolt, oil leakage, damage of pump pipe and etc.

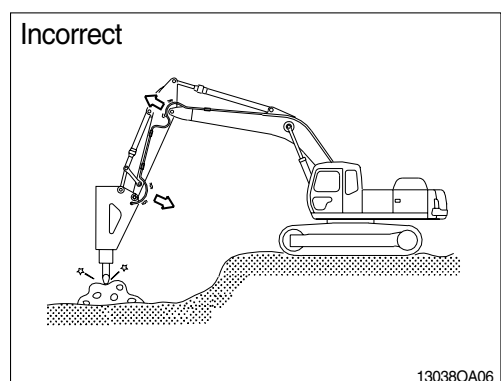

**5) DO NOT CONTINUE TO WORKING OVER ONE MINUTE AT SAME POSITION OF BOOM AND ARM**

This will increase the temperature of the oil, and cause problem in the accumulator and seals.

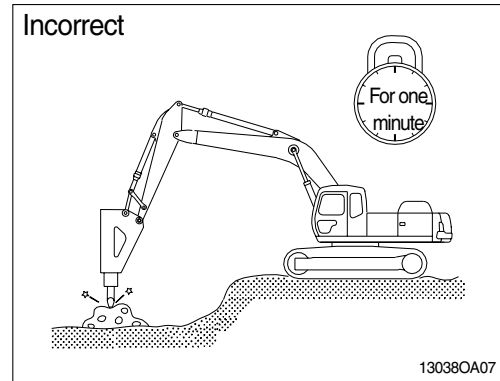

**6) DO NOT MOVE MACHINE OR BREAKER WHILE STRIKING**

Do not move hammer while striking.  
This will cause damage to the working device and the swing system.

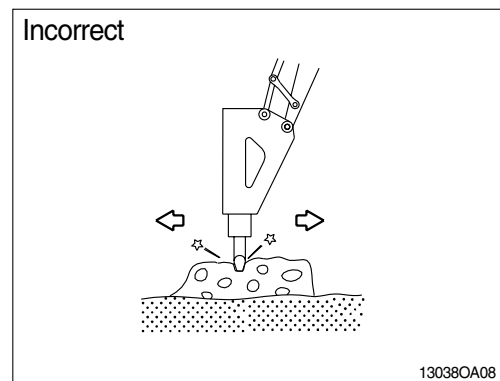

**7) DO NOT WORK WHILE SWING STATE**

Do not work while swing position of superstructure.  
It cause the band of track shoe, oil leakage of roller.

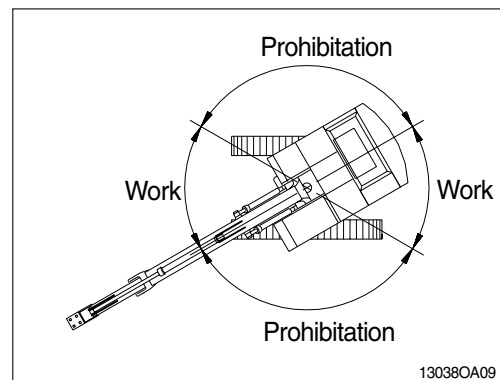

**8) TAKE CARE OF CHISEL AND BOOM INTERFACE**

Make sure of the arm and bucket control lever operation.

