

CONTROL DEVICES

1. CAB DEVICES

1) The ergonomically designed console box and suspension type seat provide the operator with comfort.

2) ELECTRONIC MONITOR SYSTEM

(1) The centralized electronic monitor system allows the status and conditions of the machine to be monitored at a glance.

(2) It is equipped with a safety warning system for early detection of machine malfunction.

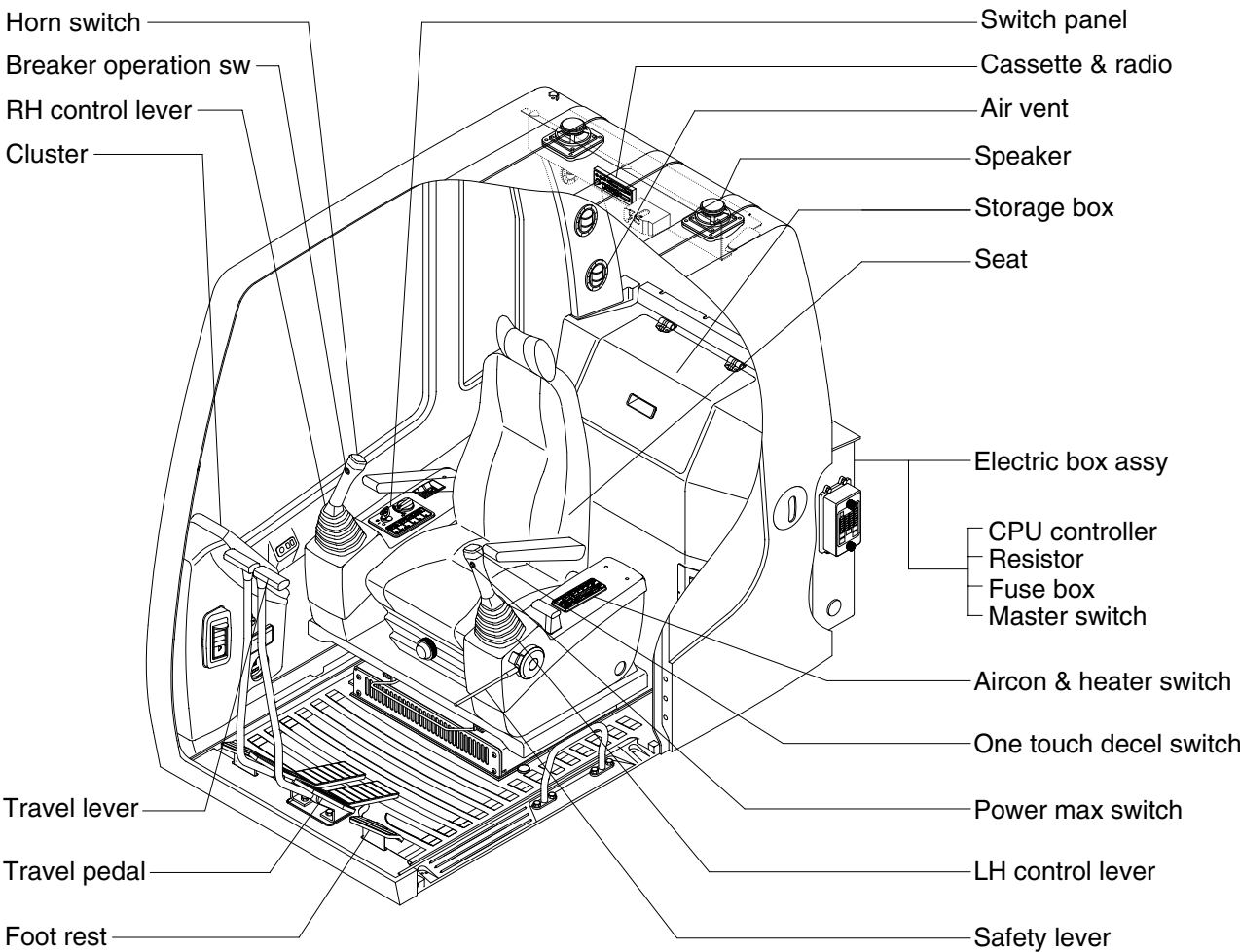

45073CD01

2. CLUSTER

1) MONITOR PANEL

The gauges panel consists of gauges and lamps as shown below, to warn the operator in case of abnormal machine operation or conditions for the appropriate operation and inspection.

- Gauges : Indicate operating status of the machine.
- Warning lamp : Indicate abnormality of the machine(Red).
- Pilot lamp : Indicate operating status of the machine(Amber).

※ The monitor installed on this machine does not entirely guarantee the condition of the machine. Daily inspection should be performed according to chapter 6, Maintenance.

※ When the monitor provides a warning immediately check the problem, and perform the required action.

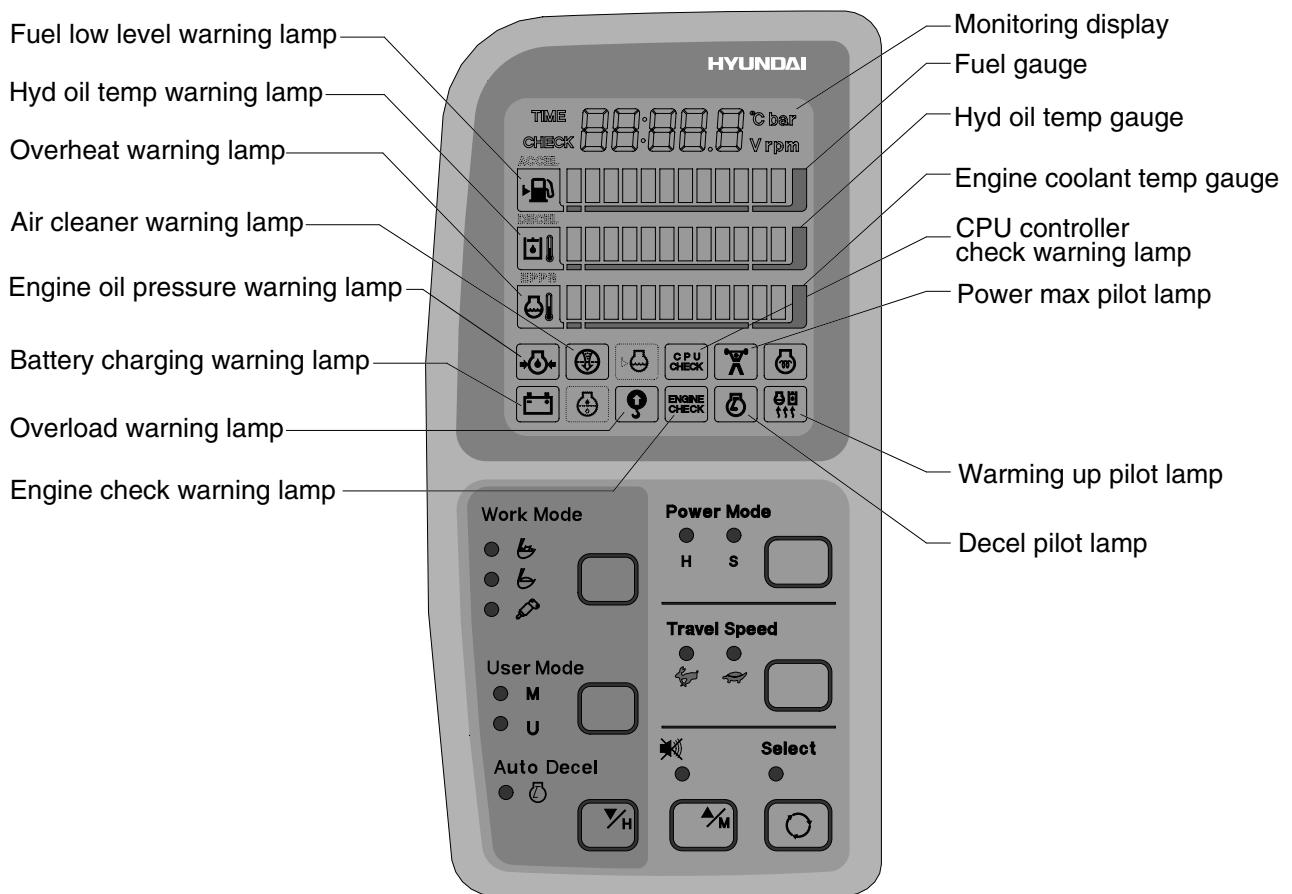

50073CD08

※ The warning lamp lights ON and the buzzer sounds when the machine has a problem. In this case, press the buzzer stop switch and buzzer stop, but the warning lamp lights until the problem is cleared.

(1) Monitoring display

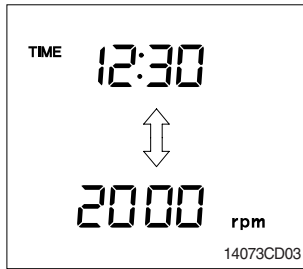

- ① This displays the current time and machine information such as engine rpm, coolant/hydraulic oil temperature, hydraulic oil pressure and also error codes.

※ Refer to the page 4-11 for details.

(2) Fuel gauge

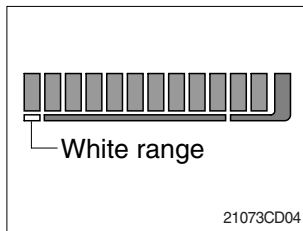

- ① This gauge indicates the amount of fuel in the fuel tank.

- ② Fill the fuel when the white range or warning lamp  blinks.

※ If the gauge illuminates the white range or warning lamp  blinks even though the machine is on the normal condition, check the electric device as that can be caused by the poor connection of electricity or sensor.

(3) Hydraulic oil temperature gauge

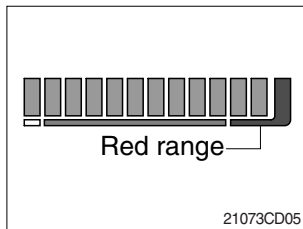

- ① This indicates the temperature of coolant.

- White range : Below 30°C(86°F)
- Green range : 30-105 °C(86-221°F)
- Red range : Above 105°C(221°F)

- ② The green range illuminates when operating.

- ③ Keep idling engine at low speed until the green range illuminates, before operation of machine.

- ④ When the red range illuminates, reduce the load on the system. If the gauge stays in the red range, stop the machine and check the cause of the problem.

(4) Engine coolant temperature gauge

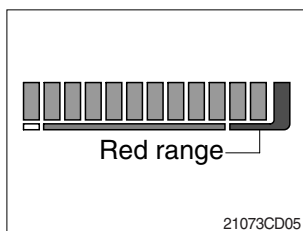

- ① This indicates the temperature of coolant.

- White range : Below 30°C (86°F)
- Green range : 30-105°C (86-221°F)
- Red range : Above 105°C (221°F)

- ② The green range illuminates when operating.

- ③ Keep idling engine at low speed until the green range illuminates, before operation of machine.

- ④ When the red range illuminates, turn OFF the engine, check the radiator and engine.

(5) Fuel low level warning lamp

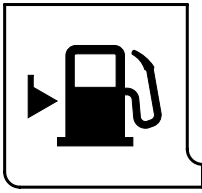

21073CD04A

- ① This lamp blinks and the buzzer sounds when the level of fuel is below 68 l (18U.S. gal).
- ② Fill the fuel immediately when the lamp blinks.

(6) Hydraulic oil temperature warning lamp

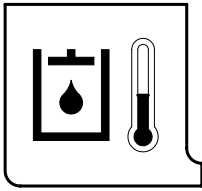

21073CD05A

- ① This warning lamp operates and the buzzer sounds when the temperature of hydraulic oil is over 105°C (221°F).
- ② Check the hydraulic oil level when the lamp blinks.

(7) Overheat warning lamp

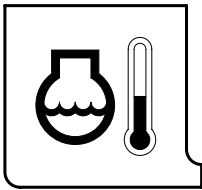

21073CD06A

- ① This lamp blinks and the buzzer sounds when the temperature of coolant is over the normal temperature 110°C (230°F).
- ② Check the cooling system when the lamp blinks.
- ③ Check for debris between oil cooler and radiator.

(8) Engine oil pressure warning lamp

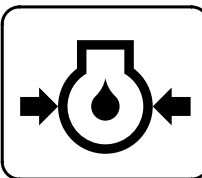

21073CD07

- ① This lamp blinks and the buzzer sounds after starting the engine because of the low oil pressure.
- ② If the lamp blinks during engine operation, shut OFF engine immediately. Check oil level.

(9) Air cleaner warning lamp

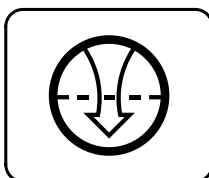

21073CD08

- ① This lamp blinks and the buzzer sounds when the filter of air cleaner is clogged.
- ② Check the filter and clean or replace it.

(10) CPU controller check warning lamp

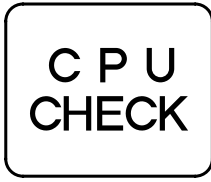

21073CD10

- ① Communication problem between CPU controller and cluster makes the lamp blink and the buzzer sounds.
- ② Check the communication line between CPU controller and cluster.

(11) Engine check warning lamp

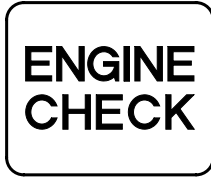

29073CD10

- ① This lamp blinks and buzzer sounds when the communication between CPU controller and ECM on the engine is abnormal or if any fault code received from ECM.
- ② Check the communication line between them.
If the communication line is OK, then check the fault code on the cluster.

(12) Battery charging warning lamp

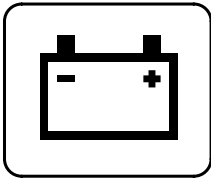

21073CD13

- ① This lamp blinks and the buzzer sounds when the starting switch is ON, it is turned OFF after starting the engine.
- ② Check the battery charging circuit when this lamp blinks, during engine operation.

(13) Overload warning lamp (Option)

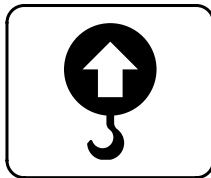

21073CD15

- ① When the machine is overload, the overload warning lamp blinks during the overload switch ON.

(14) Power max pilot lamp



21073CD11

- ① The lamp will be ON when pushing power max switch on the LH RCV lever.

(15) Decel pilot lamp

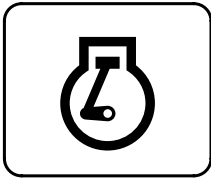

21073CD17

- ① Operating auto decel or one touch decel makes the lamp ON.
- ② The lamp will be ON when pushing one touch decel switch on the LH RCV lever.

(16) Warming up pilot lamp

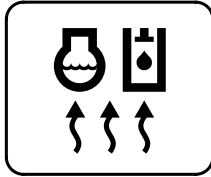

21073CD18

- ① This lamp is turned ON when the coolant temperature is below 30°C (86°F).
- ② The automatic warming up is cancelled when the engine coolant temperature is above 30°C, or when 10 minutes have passed since starting.

2) SWITCH PANEL

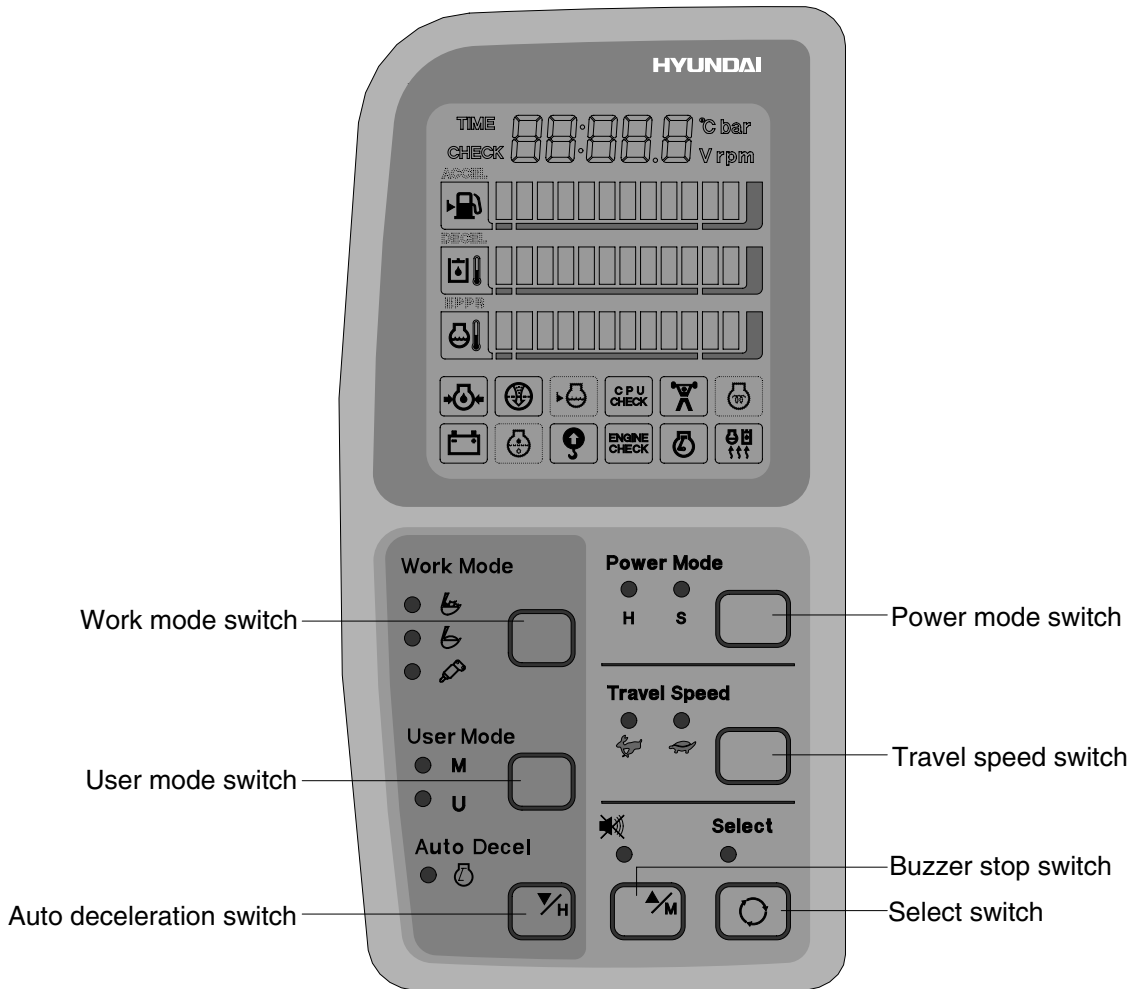

50073CD19

(1) Work mode switch

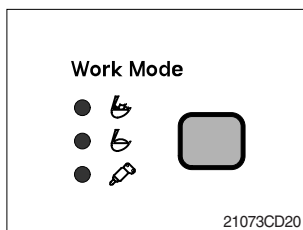

① This switch is to select the machine operation mode, which shifts from general operation mode to heavy operation mode and breaker mode in a row by pressing the switch.

- : Heavy duty work mode
- : General work mode
- : Breaker operation mode

※ Refer to the page 4-6 for details.

(2) User mode switch

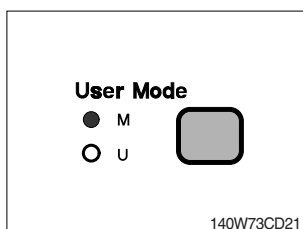

① This switch is to select the maximum power or user mode.

- M : Maximum power
- U : Memorizing operators preferable power setting

※ Refer to the page 4-6 for details.

(3) Auto deceleration switch

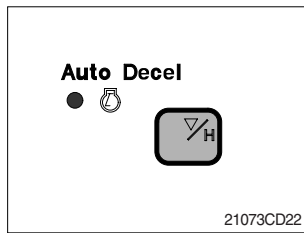

① This switch is used to actuate or cancel the auto deceleration function.

When the switch actuated and all control levers and pedals are at neutral position, engine speed will be lowered automatically to save fuel consumption.

- Light ON : Auto deceleration function is selected.
- Light OFF : Auto deceleration function is cancelled so that the engine speed increased to previous setting value.

② Operating the auto deceleration function makes the decel indicating lamp on the LCD panel ON.

(4) Power mode switch

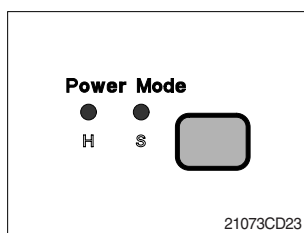

① The lamp of selected mode is turned ON by pressing the switch(), when selecting the power mode to use.

- H : This is used for high power work.
- S : This is used for standard power work.

(5) Travel speed control switch

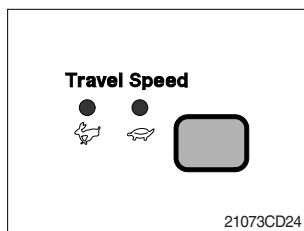

① This switch is to control the travel speed which is changed to high speed(Rabbit mark) by pressing the switch and low speed(Turtle mark) by pressing again.

(6) Buzzer stop switch

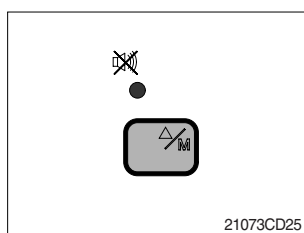

① When the starting switch is turned ON first, normally the alarm buzzer sounds for 2 seconds during lamp check operation.

② The red lamp lights ON and the buzzer sounds when the machine has a problem.

In this case, press this switch and buzzer stops, but the red lamp lights until the problem is cleared.

(7) Select switch

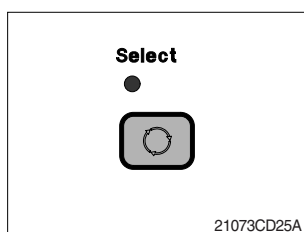

① This switch is used to select the monitor display function.

※ Refer to the page 4-11 for details.

② If the switch is pressed for 3 seconds in time display mode, it moves to time adjusting function, and you can adjust the time as below.

- Hour by auto decel()switch
- Minute by buzzer stop() switch.

③ After time set, the switch is pressed, it returns to clock display.

3. SWITCHES

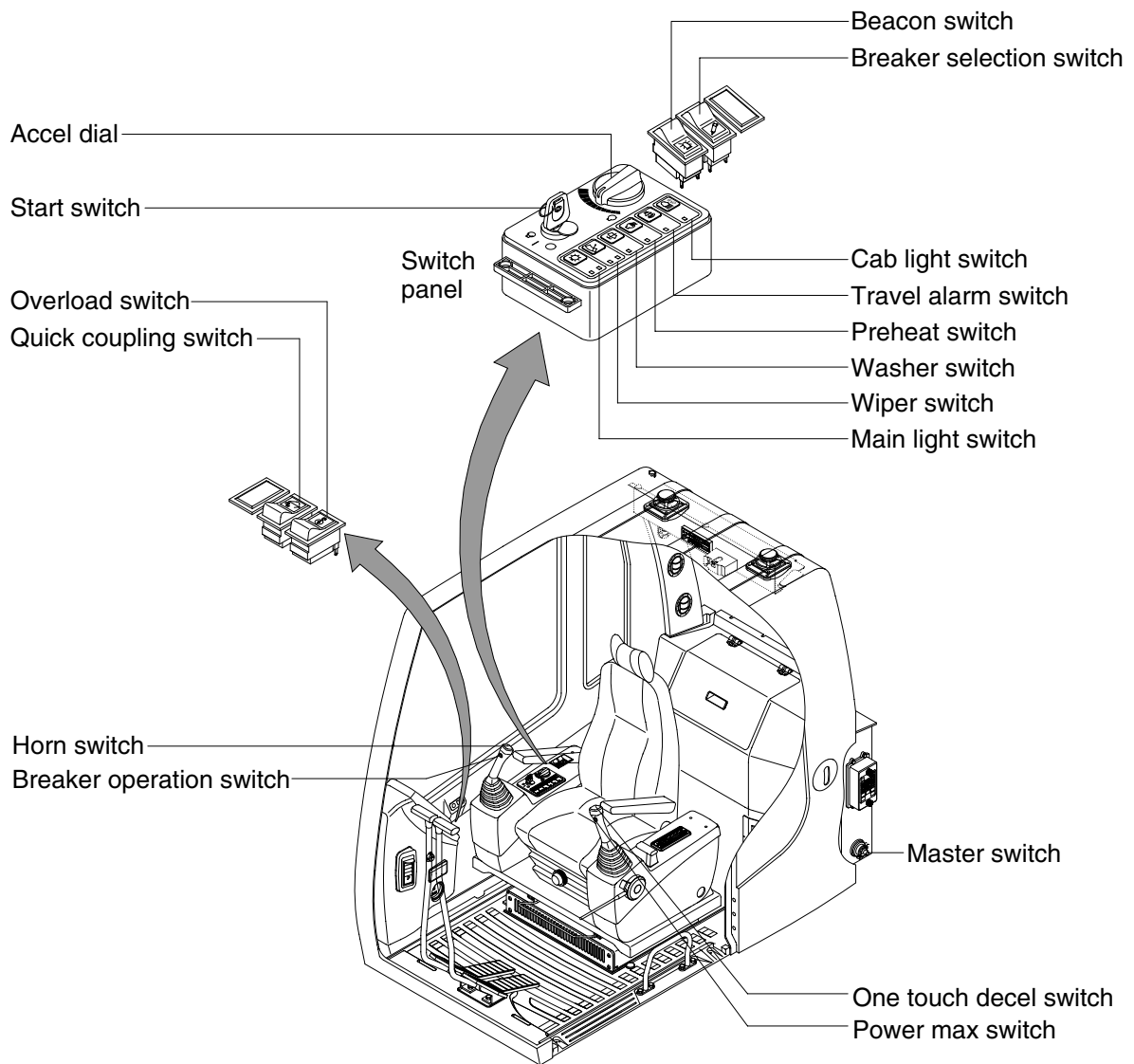

45073CD26

1) STARTING SWITCH

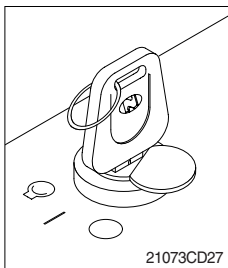

(1) There are three positions, OFF, ON and START.

- ○ (OFF) : None of electrical circuits activate.
- | (ON) : All the systems of machine operate.
- ◯ (START) : Use when starting the engine. Release key immediately after starting.

※ **Key must be in the ON position with engine running to maintain electrical and hydraulic function and prevent serious machine damage.**

2) MASTER SWITCH

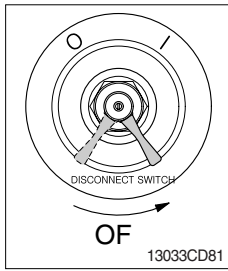

- (1) This switch is used to shut off the entire electrical system.
 - (2) I : The battery remains connected to the electrical system.
O : The battery is disconnected to the electrical system.
- ※ **Never turn the master switch to O(OFF) with the engine running. Engine and electrical system damage could result.**

3) ACCEL DIAL SWITCH

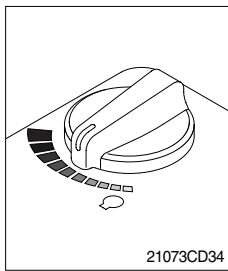

- (1) There are 10 dial setting.
- (2) Setting 1 is low idle and setting 10 is high idle.
 - By rotating the accel dial to right : Engine speed increases
 - By rotating the accel dial to left : Engine speed decreases

4) MAIN LIGHT SWITCH

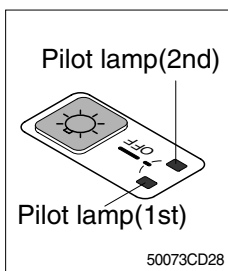

- (1) This switch used to operate the head light and work light.
 - Press the switch once to head light comes ON.
 - Press the switch once more to work light comes ON.
 - Press the switch again, return to a first step position.
 - Press the switch more than one second to turn off lights.

5) WIPER SWITCH

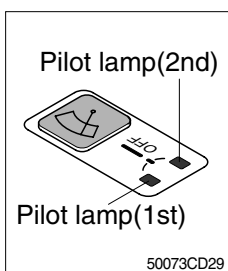

- (1) This switch used to operate wiper.
 - Press the switch once to intermittently operate wiper.
 - Press the switch once more to operate wiper low speed.
 - Press the switch again return to first step position.
 - Press the switch more than one second to turn off wiper.

6) WASHER SWITCH

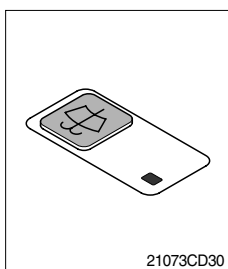

- (1) The washer liquid is sprayed and the wiper is operated only while pressing this switch.
- (2) The indicator lamp is turned ON when operating this switch.

7) PREHEAT SWITCH

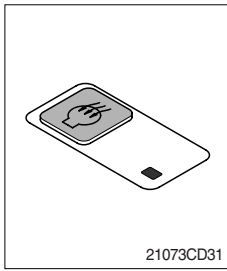

- (1) This switch is used for starting the engine in cold weather. If pressed, starting aid coil warmed to get easier engine starting.
※ **Never hold the push button switch for more than 30 seconds, as this can damage the glow coils.**
- (2) The indicator lamp is turned ON when operating this switch.

8) TRAVEL ALARM SWITCH

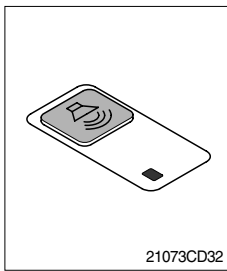

- (1) This switch is to activate travel alarm function surrounding when the machine travels to forward and backward.
- (2) On pressing this switch, the alarm operates only when the machine is traveling.

9) CAB LIGHT SWITCH(Option)

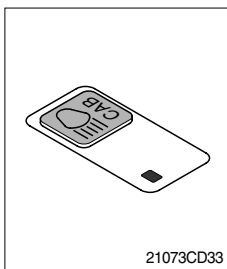

- (1) This switch used to turns ON the cab light on the cab.

10) OVERLOAD SWITCH(Option)

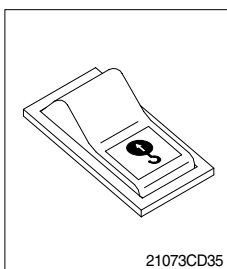

- (1) When this switch turned ON, buzzer makes sound and overload warning lamp comes ON in case that the machine is overload.
- (2) When turn OFF buzzer stops and warning lamp goes out.

11) BREAKER SELECTION SWITCH(Option)

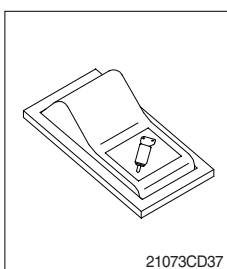

- (1) This switch is used to select breaker.
※ **The breaker operates only when this switch is selected.**

12) BEACON SWITCH (Option)

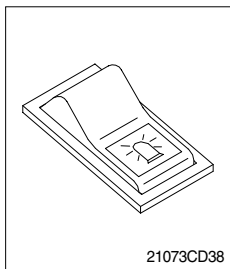

- (1) This switch turns ON the rotary light on the cab.
- (2) The below indicator lamp is turned ON when operating this switch.

13) HORN SWITCH

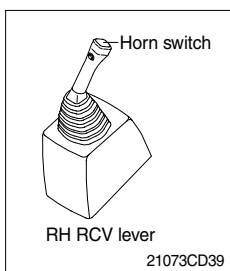

- (1) This switch is at the top of right side control lever. On pressing, the horn sounds.

14) BREAKER OPERATION SWITCH

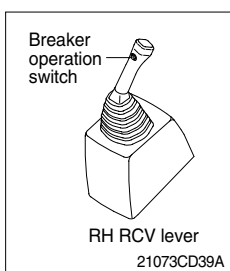

- (1) On pressing this switch, the breaker operates only when the breaker selection switch on the switch panel is selected.

15) ONE TOUCH DECEL SWITCH

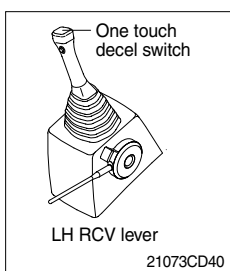

- (1) This switch is used to actuate the deceleration function quickly.
- (2) The engine speed is increased to previous setting value by pressing the switch again.

16) POWER MAX SWITCH

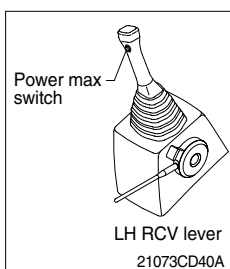

- (1) This switch activate power max function. When this switch is kept pressed, hydraulic power of work equipment will increased approx 110 percent during 8 seconds.
 - (2) After 8 seconds, function is cancelled automatically even switch is keep pressed.
- ※ **Don not use for craning purposes.**

4. LEVERS AND PEDALS

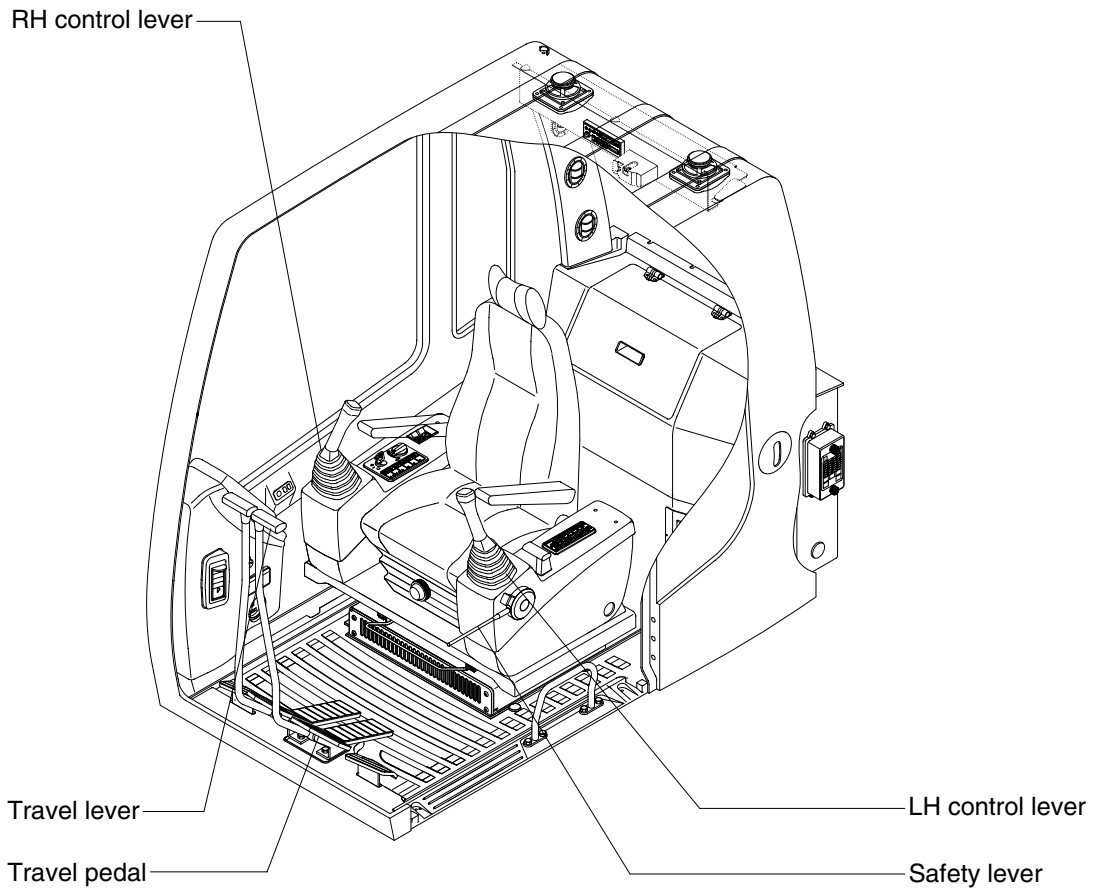

45073CD41

1) LH CONTROL LEVER

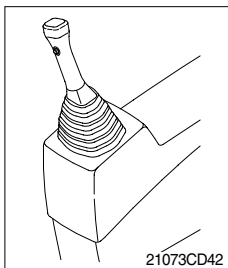

- (1) This joystick is used to control the swing and the arm.
- (2) Refer to **operation of working device** in chapter 4 for details.

2) RH CONTROL LEVER

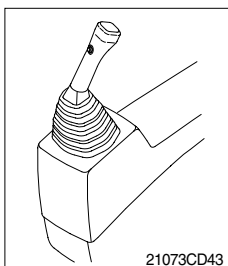

- (1) This joystick is used to control the boom and the bucket.
- (2) Refer to **operation of working device** in chapter 4 for details.

3) SAFETY LEVER

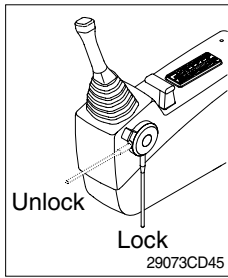

- (1) All control levers and pedals are disabled from operation by locating the lever to lock position as shown.
 - ※ **Be sure to lower the lever to LOCK position when leaving from operator's seat.**
- (2) By pulling lever to UNLOCK position, machine is operational.
 - ※ **Do not use the safety lever for handle when getting on or off the machine.**

4) TRAVEL LEVER

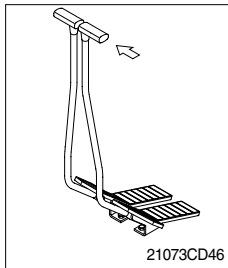

- (1) This lever is mounted on travel pedal and used for traveling by hand. The operation principle is same as the travel pedal.
- (2) Refer to **traveling of the machine** in chapter 4 for details.

5) TRAVEL PEDAL

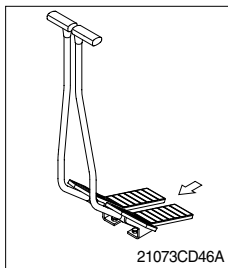

- (1) This pedal is used to move the machine forward or backward.
- (2) If left side pedal is pressed, left track will move.
If right side pedal is pressed, right track will move.
- (3) Refer to **traveling of machine** in chapter 4 for details.

6) SEAT AND CONSOLE BOX ADJUST LEVER

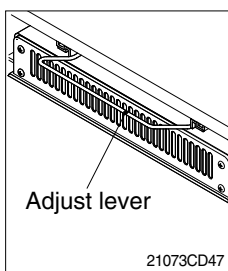

- (1) This lever is used to move the seat and console box to fit the contours of the operator's body.
- (2) Pull the lever to adjust forward or backward over 170mm(6.7").

5. AIR CONDITIONER AND HEATER

Air conditioner and heater are equipped for pleasant operation against outside temperature and defrost on window glass.

- Location of air flow ducts

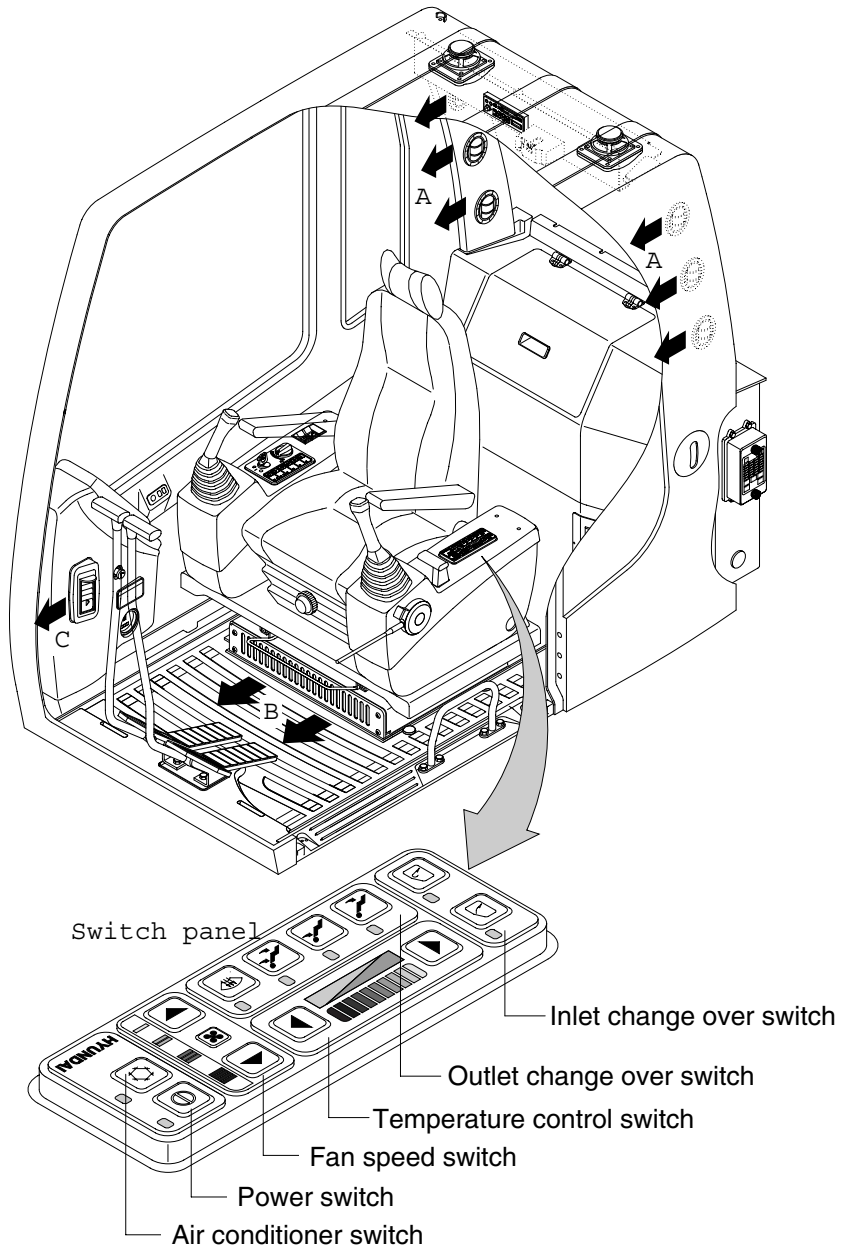

36073CD48

1) POWER SWITCH

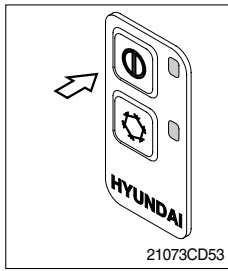

(1) This switch makes the system and the LED simultaneously ON or OFF.

(2) Default setting values

Function	Air conditioner	Fan speed	Temperature	Outlet	Inlet
Value	OFF	1	Max cool	Face	Recirculation

2) AIR CONDITIONER SWITCH(Compressor switch)

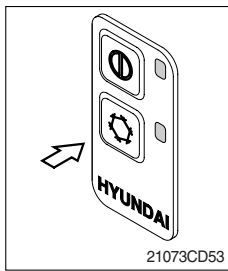

(1) Operating this switch turns the compressor and the LED simultaneously on or off.

(2) In accordance with the evaporator temperature, compressor turns on or off automatically without changing LED state.

※ **Air conditioner operates to remove vapor and drains water through a drain hose. Water can be sprayed into the cab in case that the vacuum valve of drain hose has a problem. In this case, exchange the vacuum valve.**

3) FAN SPEED SWITCH

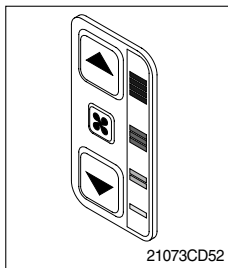

(1) It is possible to control the fan to four steps.

(2) The first step or the fourth step gives 5 times beeps.

4) TEMPERATURE CONTROL SWITCH

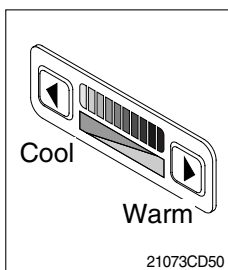

(1) There are 9 steps to control temperature from max cool to max warm controlled up and down by 1 step.

(2) Max cool and max warm arouse 5 times beeps.

(3) For the max warm or the max cool it's better to be configured as following table.

Temperature	Air conditioner	Fan speed	Outlet	Inlet
Max cool	ON	4	Face	Recirculation
Max warm	OFF	3	Foot	Fresh

5) OUTLET CHANGE OVER SWITCH

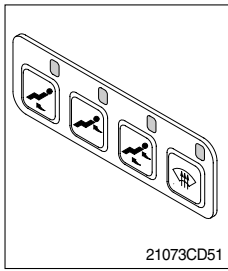

(1) There are four steps of air flow.

Switch position		Mode			
Outlet	A		●	●	
	B	●		●	●
	C				●

(2) When defroster switch operating, INLET switch turns to FRESH mode and air conditioner switch turns ON.

(3) In case of heating range(5~Max warm), air conditioner won't turns ON.

6) INLET CHANGE OVER SWITCH

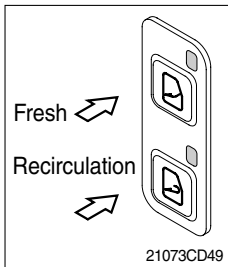

(1) It is possible to change the air-inlet method.

① Fresh

Inhaling air from the outside to pressurize cab inside.

※ **Check out the fresh air filter periodically to keep a good efficiency.**

② Recirculation

It recycles the heated or cooled air to increase the energy efficiency.

※ **Change air occasionally when using recirculation for a long time.**

※ **Check out the recirculation filter periodically to keep a good efficiency.**

(2) Recirculation function operates when the system is OFF but it can be changed whenever needed.

■ **AUTO AIR CONDITIONER AND HEATER(OPTION)**

Auto air conditioner and heater system automatically keeps the optimum condition in accordance with operator's temperature configuration sensing ambient and cabin inside temperature.

- Location of air flow ducts

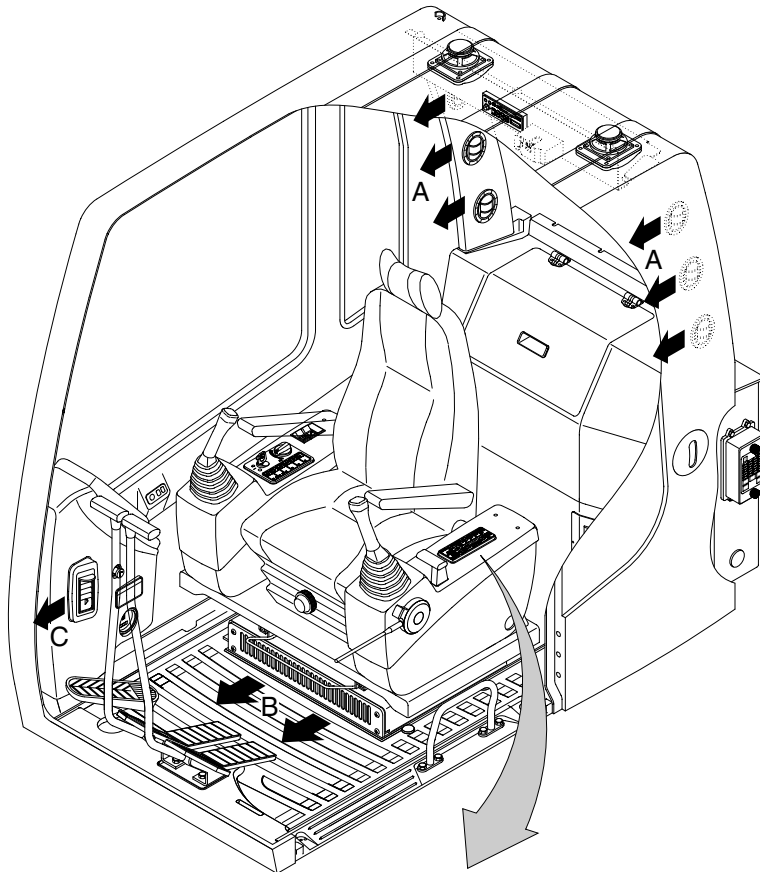

Switch panel

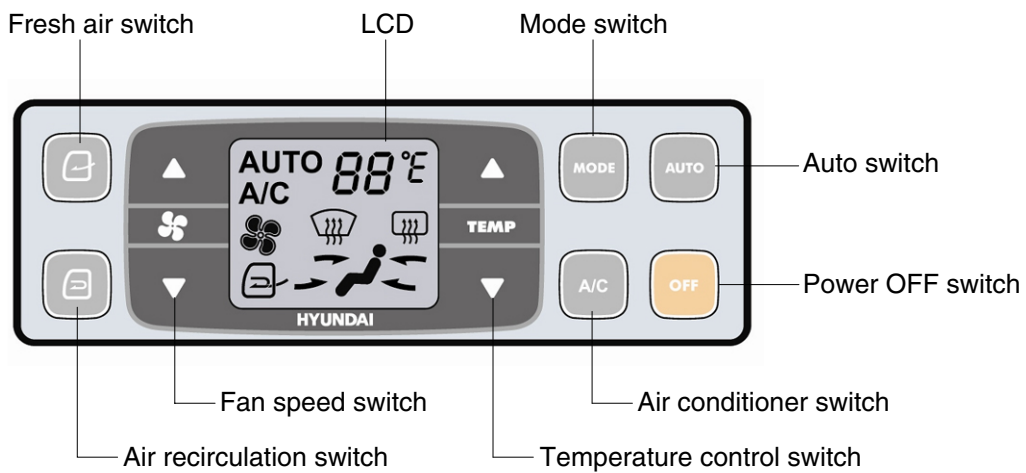

3607A3CD48

1) POWER OFF SWITCH

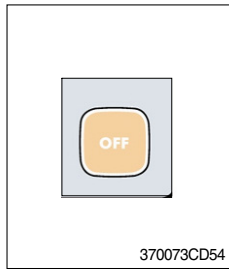

- (1) This switch makes the system and the LED OFF.
Just before the power OFF, setted values are stored.

(2) Default setting values

Function	Air conditioner	In/outlet	LCD	Temperature	Mode
Value	OFF	Inlet	OFF	Previous sw OFF	Previous sw OFF

2) AUTO SWITCH

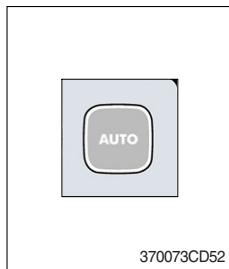

- (1) Turn the starting switch to ON position, LCD lights ON.
Auto air conditioner and heater system automatically keeps the optimum condition in accordance with operator's temperature configuration sensing ambient and cabin inside temperature.
- (2) This switch can restart system after system OFF.

3) AIR CONDITIONER SWITCH(Compressor switch)

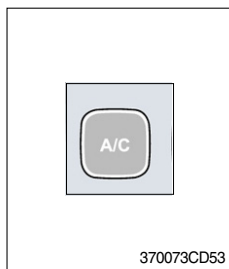

- (1) This switch turns the compressor and the LCD ON.
 - (2) In accordance with the temperature sensed by duct(evaporator) sensor, compressor turns ON or OFF automatically.
- ※ **Air conditioner operates to remove vapor and drains water through a drain hose. Water can be sprayed into the cab in case that the drain cock at the ending point of drain hose has a problem.**
In this case, exchange the drain cock.

4) FAN SPEED SWITCH

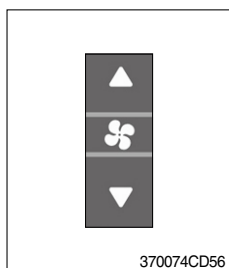

- (1) Fan speed is controlled automatically by setted temperature.
- (2) This switch controls fan speed manually.
 - There are 8 up/down steps to control fan speed.
 - The maximum step or the minimum step beeps 5 times.
- (3) This switch makes the system ON.
 - ▲ : First step(AUTO)
 - ▼ : First step(Manually)

5) TEMPERATURE CONTROL SWITCH

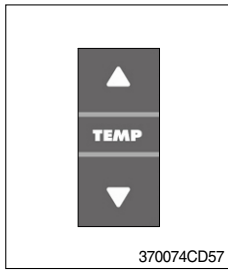

- (1) Setting temperature indication(17~32°C, Scale : 1°C)
- (2) Max cool and max warm beeps 5 times.
- (3) The max cool or the max warm position operates as following table.

Temperature	Compressor	Fan speed	In/Outlet	Mode
Max cool	ON	Max(Hi)	Recirculation	Vent
Max warm	OFF	Max(Hi)	Fresh	Foot

6) MODE SWITCH

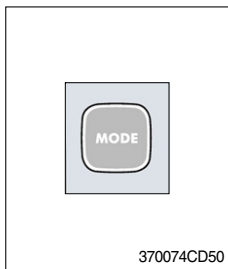

- (1) Operating this switch, it beeps and displays symbol of each mode in order.(Vent → B/L → Foot → Def → Vent)

Mode switch		Vent	B/L	Foot	Defroster
Outlet	A	●	●		
	B		●	●	●
	C				●

- (2) When defroster switch operating, FRESH AIR/AIR RECIRCULATION switch turns to FRESH AIR mode and air conditioner switch turns ON.
- (3) When this switch ON, the system operates with previous configuration.

7) FRESH AIR/AIR RECIRCULATION SWITCH

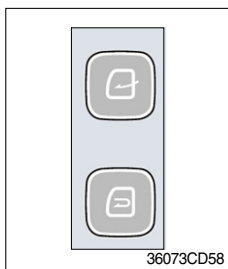

- (1) It is possible to change the air-inlet method.
 - ① **Fresh air** ()
Inhaling air from the outside.
※ **Check out the fresh air filter periodically to keep a good efficiency.**
 - ② **Air recirculation** ()
It recycles the heated or cooled air to increase the energy efficiency.
※ **Change air occasionally when using recirculation for a long time.**
※ **Check out the recirculation filter periodically to keep a good efficiency.**

8) SELF DIAGNOSIS FUNCTION

(1) Procedure

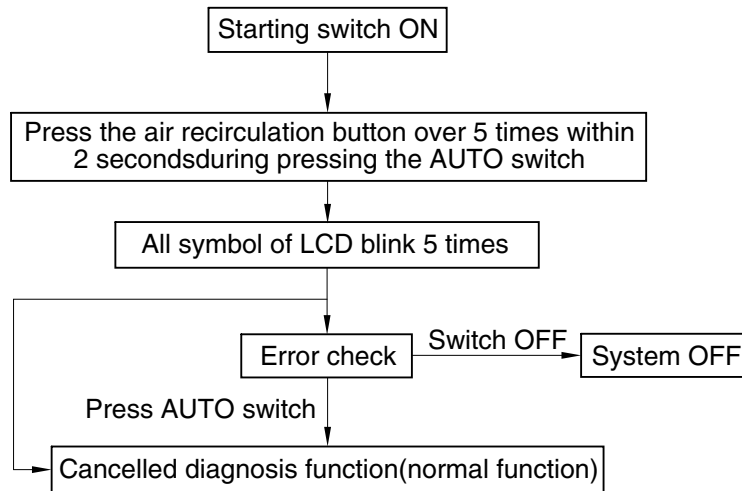

3607A3CD69

(2) Error check

- The corresponding error code flickers on the setup temperature display panel, the other symbol will turn OFF.
- Error code flickers every 0.5 second.
- If error code is more than two, each code flickers 2 times in sequence.
- Error code

Error code	Description	Error code	Description
11	Ambient sensor	14	Duct(evaporator) sensor
12	Cabin inside sensor	15	Temp actuator
13	Coolant temp sensor	16	Mode actuator

(3) Fail safe function

Error description	Fail safe function
Ambient sensor(11)	25°C alternate value control
Cabin inside sensor(12)	20°C alternate value control
Coolant temp sensor(13)	More than 10 minutes after engine start up, the alternate value is ON
Duct(evaporator) sensor(14)	1°C alternate value control
Temp actuator(15)	If opening amount is 0%, the alternate value is 0%
	If not, the alternate value is 100%
Mode actuator(16)	The alternate value is Vent

6. OTHERS

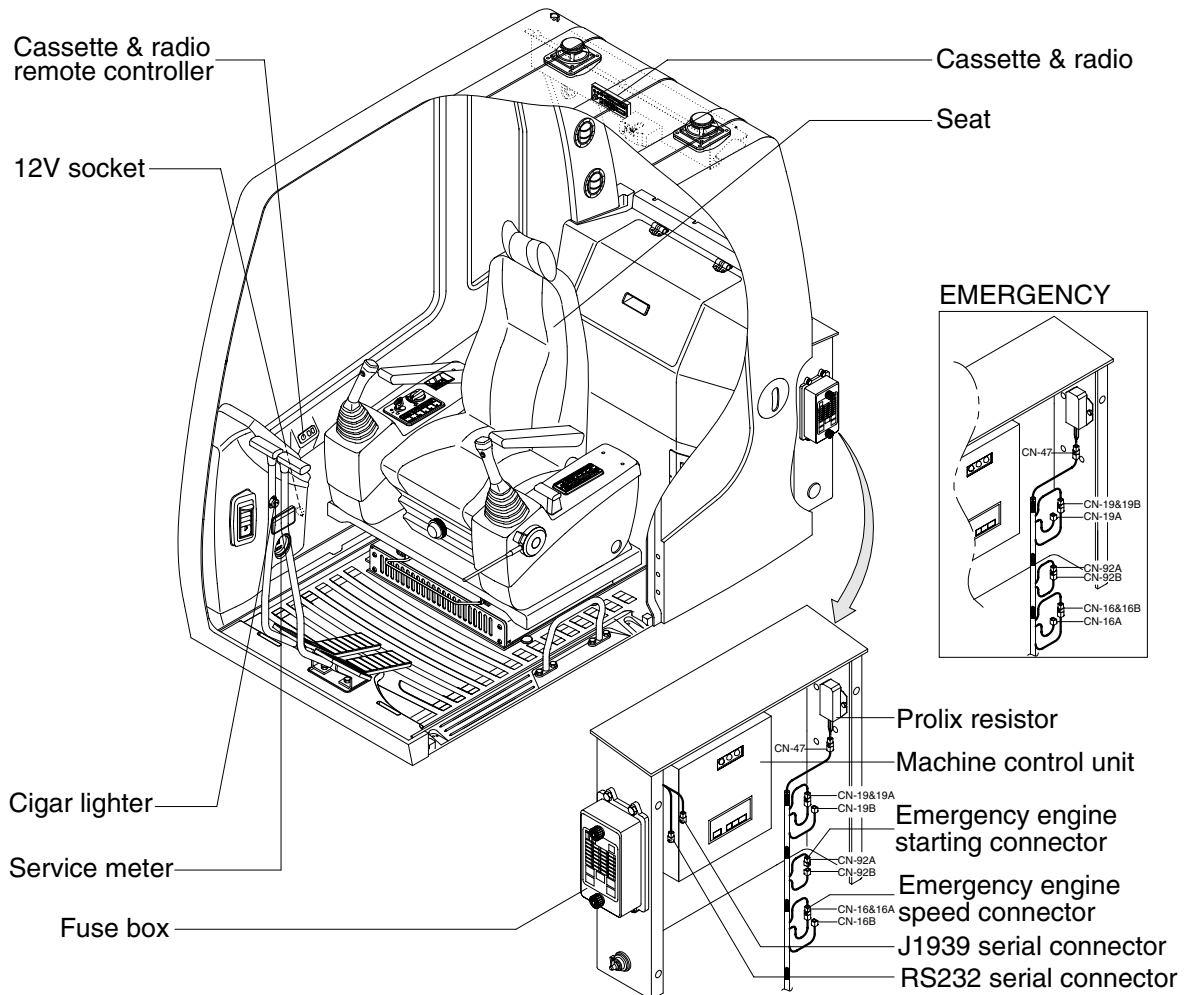

36073CD54

1) CIGAR LIGHTER

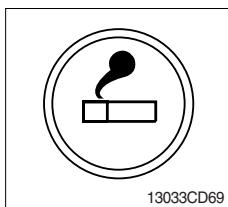

- (1) This can be used when the engine starting switch is ON.
 - (2) The lighter can be used when it springs out in a short while after being pressed down.
- ※ **Service socket**
Use cigar lighter socket when you need emergency power.
Do not use the lighter exceeding 24V, 100W.

2) SEAT

The seat is adjustable to fit the contours of the operator's body. It will reduce operator fatigue due to long work hours and enhance work efficiency.

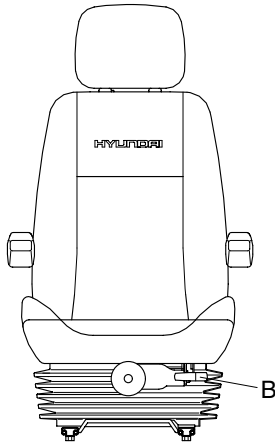

(1) Forward/Backward adjustment(A)

- ① Pull lever A to adjust seat forward or backward.
- ② The seat can be moved forward and backward over 170mm(6.7") in 17 steps.

(2) Upward/Downward adjustment(B)

- ① Pull lever B to adjust seat upward or downward.
- ② Forward or backward side adjustment only can be made, tilting to one side, by moving lever B respectively.

(3) Reclining adjustment(C)

Pull lever C to adjust seat back rest.

(4) Arm rest adjustment(E)

This can be adjusted by pushing the button E to right and left.

(5) Head rest adjustment (D)

This is adjustable vertically to fit operator's requirements.

(6) Cushion adjustment (F)

Adjust the handle to the operator's weight.

▲ Always check the condition of the seat belt and mounting hardware before operating the machine.

▲ Replace the seat belt at least once every three years, regardless of appearance.

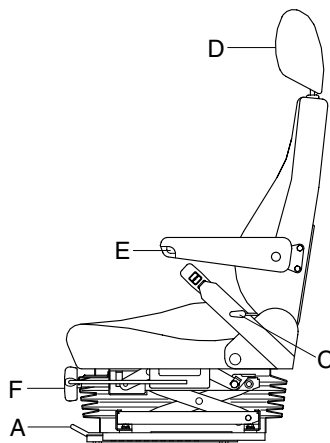

95W33CD16

3) 12V SOCKET(Option)

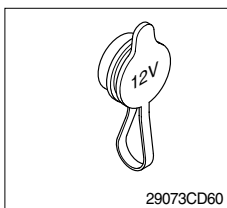

- (1) Utilize the power of 12V as your need and do not exceed power of 12V, 30W.

4) FUSE BOX

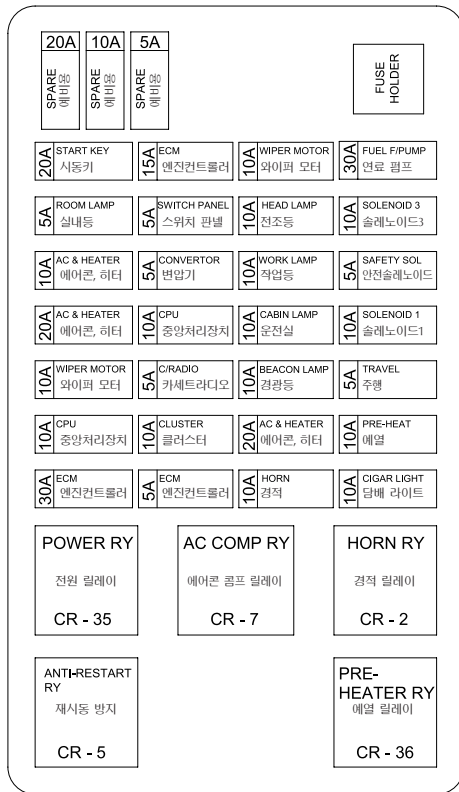

45073CD56

(1) The fuses protect the electrical parts and wiring from burning out.

(2) The fuse box cover indicates the capacity of each fuse and circuit it protects.

※ Replace a fuse with another of the same capacity.

▲ Before replacing a fuse, be sure to turn OFF the starting switch.

5) CPU CONTROLLER

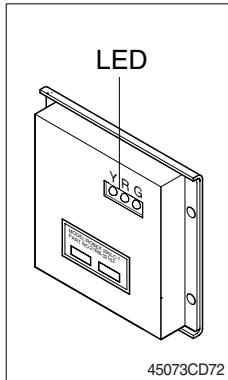

45073CD72

(1) To match the engine torque with the pump absorption torque, CPU controller varies EPPR valve output pressure, which control pump discharge amount whenever feedbacked engine speed drops under the reference rpm of each mode set.

(2) Three LED lamps on the CPU controller display as below.

LED lamp	Trouble	Service
G is turned ON	Normal	-
G and R are turned ON	Trouble on CPU or ROM	· Change the controller
G and Y are turned ON	Trouble on serial communication line	· Check if serial communication lines between controller and cluster are disconnected
Three LED are turned OFF	Trouble on CPU controller power	· Check if the input power wire (24V, GND) of controller is disconnected · Check the fuse

G : green, R : red, Y : yellow

6) EMERGENCY ENGINE STARTING CONNECTOR

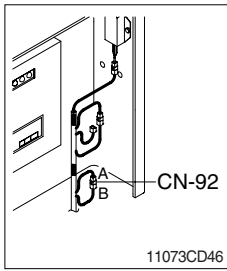

- (1) If the CPU controller is removed, the engine does not start.
 - (2) Before starting the engine, connect the connector CN-92 A with B.
- ※ **Do not connect these connectors when the CPU is not removed.**

7) EMERGENCY ENGINE SPEED CONTROL

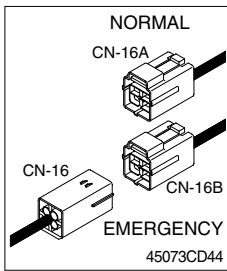

- (1) When the CAN communication between the ECM and the CPU controller is abnormal due to malfunction of the CPU controller, change CN-16 connection from CN-16A to CN-16B and then control the engine speed by rotating accel dial switch.

8) PROLIX RESISTOR

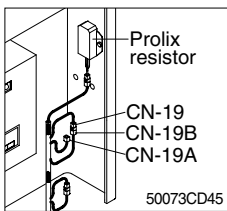

- (1) This resistor is used to continuous working in case of malfunction of the CPU controller.
 - Normal : CN-19 connect with connector CN-19A
 - Emergency : CN-19 connect with connector CN-19B
- ※ **Never connect connector CN-19 with connector CN-19B when CPU controller is in normal operation.**

9) SERVICE METER

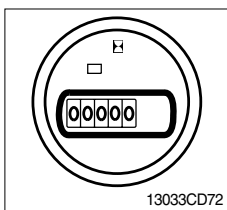

- (1) This meter shows the total operation hours of the machine.
- (2) Always ensure the operating condition of the meter during the machine operation. Inspect and service the machine based on hours as indicated in chapter 6, **maintenance**.

10) RS232 SERIAL CONNECTOR

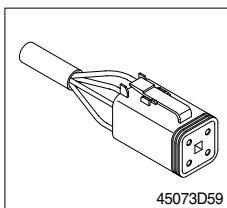

- (1) CPU controller communicates the machine data with Lap top computer through RS232 connector.

11) J1939 SERIAL CONNECTOR

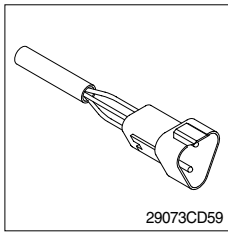

(1) ECM communicates the engine data with cummins INLINE-II adapter through J1939 connector.

- ① ECM fault code check
- ② ECM program change
- ③ Engine data monitoring & test

12) UPPER WINDSHIELD

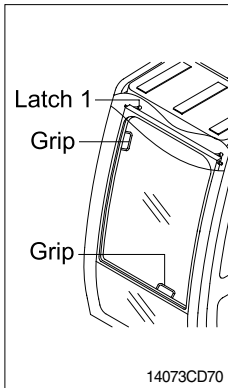

(1) Perform the following procedure in order to open the upper windshield.

- ① Release both latches(1) in order to release the upper windshield.
- ② Hold both grips that are located at the bottom of the windshield frame and at the top of the windshield frame push the windshield upward.
- ③ Hold both grips that are provided on the windshield frame and back into the storage position until auto lock latch(2) is engaged, move the levers of both latches(1) into the locked position. Push the levers toward the rear of the cab in order to hold the windshield in storage position.

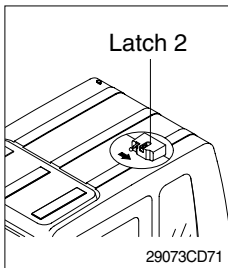

(2) Perform the following procedure in order to close the upper windshield.

- ① Move the lever of the auto lock latch(2) in the direction of the arrow in order to release the auto lock latch.
- ② Reverse step ① through step ③ in order to close the upper windshield.

13) RADIO AND CASSETTE(Standard)

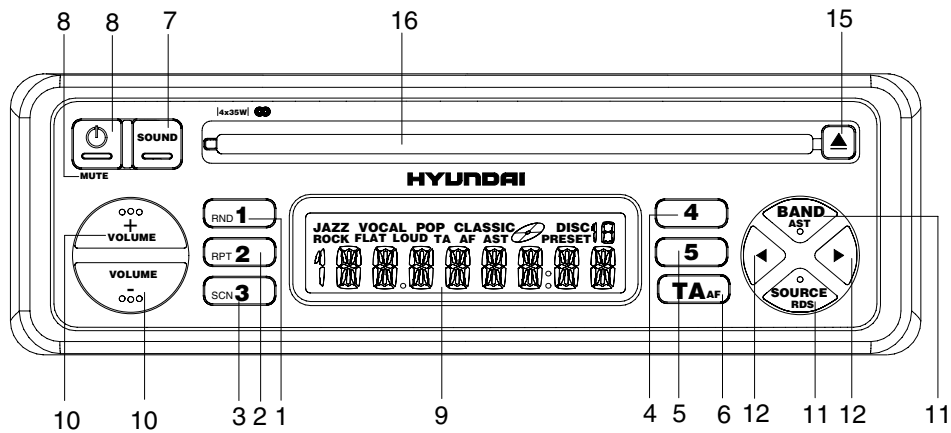

7807A3CD81

RADIO AND CD PLAYER(Optional)

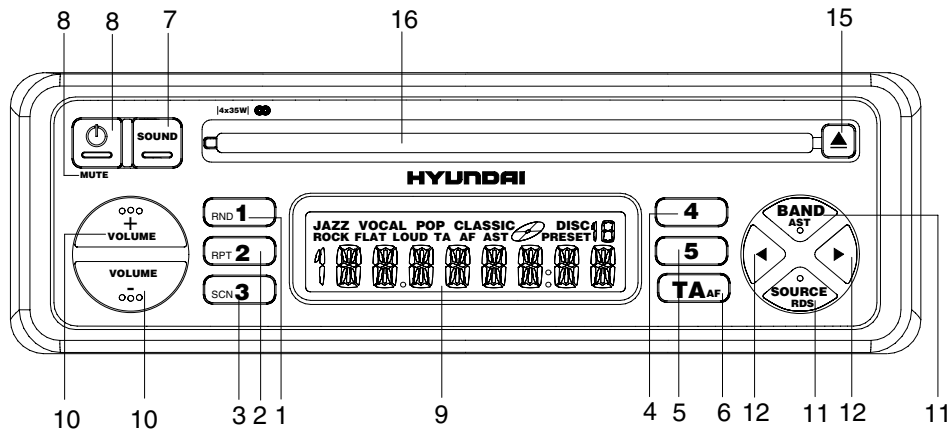

7807A3CD82

■ FRONT PANEL PRESENTATION

- | | | | |
|----|---|----|--|
| 1 | 1 Preset button 1 | 11 | SOURCE .. Short press : Change source(Radio/CD) |
| | RND CD random playback on/off | | RDS Long press : RDS on/off |
| 2 | 2 Preset button 2 | | BAND Short press : To select band |
| | RPT CD repeat track on/off | | AST Long press : Autostore(CD) |
| 3 | 3 Preset button 3 | | Short press : Autostore(Cassette) |
| | SCN CD's track scan | 12 | ◀▶ Tuner mode |
| 4 | 4 Preset button 4 | | Short press : Auto search up/down |
| 5 | 5 Preset button 5 | | Long press : Manual search up/down |
| 6 | TA AF Short press : TA on/off | | Cassette mode : No function |
| | Long press : AF on/off | | CD mode |
| 7 | SOUND Select sound/audio styles | | Short press : Next/previous track |
| 8 | ⏻ Short press : power on | | Long press : Fast forward or fast rewind |
| | Long press : power off | 13 | ▶▶ Fast forward(cassette deck) |
| | MUTE Short press : To mute or cancel mute. | 14 | ◀◀ Fast rewind(cassette deck) |
| 9 | Display | 15 | ▲ Disc eject(CD) |
| 10 | Volume knob : Press up/down to adjust the volume ; adjust selected audio mode | | Eject cassette |
| | | 16 | CD opening / Cassette opening |

■ AUDIO

(1) Power and mute button

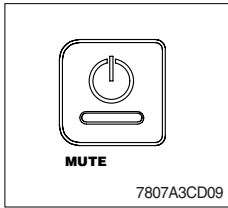

① POWER ON/OFF

Press to switch on the set. Press for more than 2 seconds to switch off the set.

② MUTE(Silence)

Short press key to mute or cancel the mute(silence).

※ The silence period may be interrupted by ALARM announcement or traffic announcement messages(if TA is switched on).

(2) Volume button

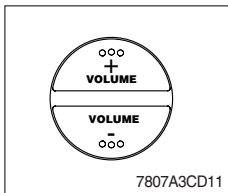

① Press the volume button up/down to adjust the volume.

Please make sure you can still hear the traffic(horns, sirens..).

(3) Sound button

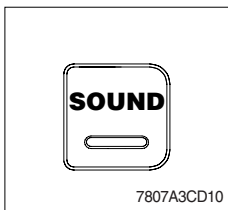

① SOUND

Whether you listen to Jazz, Vocal, Pop, Classic or Rock music, the SOUND button is the perfect setting for your choice.

- Press SOUND then the sound button to select BASS-Treb for your own sound style, or adjust the settings with the volume up/down buttons to select one of the pre define sound styles:

- BASE -TRE : Your own settings of bass and treble.
- FLAT : Original
- JAZZ : Jazz music
- VOCAL : Speech
- POP : Pop music
- CLASSIC : Classical music
- ROCK : Rock music

② AUDIO SETTING

- Press SOUND to select desired audio mode.
- Adjust the settings with the volume up/down buttons :

- Sound style : BASS-TRE, FLAT, JAZZ, VOCAL, POP, CLASSIC, ROCK
- BASS : Low notes
- TREBLE : High notes
- BALANCE : Left-right
- FADER : Rear-front
- LOUD : OFF, LOW, MID, HIGH

- Press the volume button to adjust the selected audio mode. After 5 seconds the display goes back to the last mode of operation. Adjustment of Bass and Treble settings is only possible when BASS-TRE is selected as the sound style.

(4) Source button

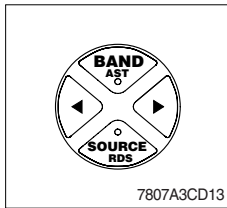

① Press SOURCE to select the desired source :

↻ - TUNER
↻ - CD

※ Products with cassette mechanism will change source to cassette only when a tape is inserted.

■ RADIO

(1) Wave band / Automatic search button

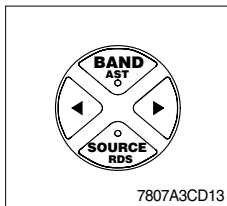

① WAVEBAND

· Press BAND to select the desired band:

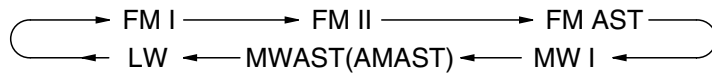

② AUTOMATIC SEARCH

Use search tuning to automatically search for a station.

- Press ◀ to tune a station of a lower frequency or ▶ to a higher frequency.
- To search for another station, press the key again.

③ MANUAL TUNING(If you know the frequency of the required station)

· **To switch to manual tuning :**

Long press the search button ◀ or ▶ for more than 2 seconds will switch the tuning to manual tuning.

· Then press ◀ to tune to a station of a lower frequency or ▶ to a higher frequency.

· When keys are released, a time-out start to count. After 5 seconds time-out, display 'Auto' for one second and return to automatic search.

(2) Preselected button

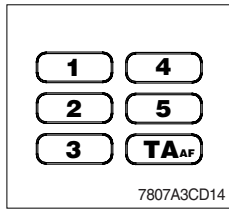

Preselected stations

① Manually storing stations in a preset

Five stations per band can be stored and recalled using the preset keys(1 to 5).

Tune in to the desired station.

- Press the desired preset key(1 to 5) for more than 2 seconds to
- store the current tuned station.

When storing an FM station, the current program station name and the AF mode are stored on the preset(Some stations use alternating program service name).

② Recalling a preset

Press the desired preset key(1 to 5) to recall the stored station.

③ Automatically storing stations(AUTO-STORE)

You can automatically store 5 strongest FM stations on the FM AST band or 5 strongest MW(AM) stations on the MW(AM) AST band. When you use Auto store, the new stations replace any stations previously stored in the FM AST band or the MW(AM) AST band.

- Press AST to activate autostore.
- The set gives a beep and then mutes.
- When it has finished, you hear a beep followed by the station stored on preset 1.
- Sometimes it may not be possible to find 5 stations.

■ RADIO DATA SYSTEM(RDS) ON FM

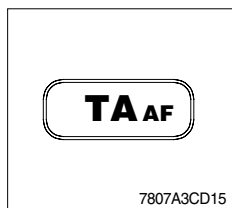

More and more stations broadcasts RDS informations in order to offer you many advantages including:

(1) Program service name(PS)

Allows the radio to display the name of the station instead of its frequency.

(2) Automatic returning(AF)

The set remains tuned to the current station by continually searching the best alternative frequency for best reception.

You can switch AF off.

- Activate/Deactivate AF

This set continuously search for other alternative frequencies for the tuned radio station and automatically selects the best frequency for reception. Long press  for more than 2 second to activate/deactivate AF.

(3) Alarm messages(PHY ALARM)

This set automatically receives emergency messages made by the broadcaster.

- During the messages the display shows 'ALARM' and the station-name alternately.

(4) Traffic announcements(TA)

You can activate the TA modes to give priority so as to hear traffic announcements related to these subjects(even if you play a cassettes/CD or mute the set).

- Activate/Deactivate TA

- Short press BAND to select an FM band.
- Press  to activate/deactivate TA.

- If you activate TA mode

- You will hear the traffic announcements when broadcast by station(even if you play a cassette/CD or mute the set).
- If the tuned station does not enable the reception of traffic announcements, the display shows 'NO TA'. The radio automatically searches and appropriate station.

- Interrupting traffic announcement mode

If you do not wish to continue listening to a particular traffic announcement

- Short press  key to interrupt traffic announcement without switching off the mode
- The set will return to the previous operating mode.

※ You can switch off RDS features if not required.

- Long press RDS key to switch off RDS.
- All RDS related features e.g., TA, etc...will be deactivated when RDS is switch off.

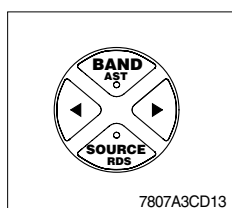

■ CASSETTE PLAYER

(1) Winding/Rewinding button

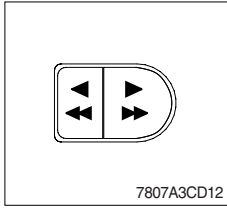

- ※ Only use good quality cassettes.
- ※ To avoid possible tape damage always take out the cassette after use. Protect your cassettes. Put them back in their boxes immediately after use.
- ※ Never expose cassettes to heat or direct sunlight.

① Play back

Slide the cassette, with the open side to the right into the cassette opening. Playback starts.

The direction of playback is shown by indicator ► .

② Stopping playback(▲)

- To stop playback, Press the ▲ button fully home.
- The unit will switch over to radio reception.
- The cassette is partially ejected.

③ Reverse(before the end of the tape)

Press the ◀◀ and ▶▶ buttons at the same time halfway in.

④ Fast rewind / Fast forward(◀◀ or ▶▶)

The direction of fast winding depends on the direction of play indicated on the display.

Display during playback	Action	Key to press
►	Fast forward	▶▶
▶	Fast rewind	◀◀
◀	Fast forward	◀◀
◀	Fast rewind	▶▶

During fast forward or rewind the radio resumes. If you continue fast winding until the end of the tape, play back restarts automatically.

⑤ To stop fast winding

To stop fast winding before the end of the tape, press the key which is not pressed(◀◀ or ▶▶). Playback is then resumed.

⑥ End of the tape

At the end of the tape, playback continues in the revers direction.

⑦ Maintenance

After extended use of the cassette player, dust, contamination or grime can accumulate on the playback head.

This results in diminishing high-note reproduction. This can be remedied using a cleaning cassette(one or twice a month) and playing it through like an ordinary cassette.

■ CD PLAYER

(1) Winding / Rewinding button

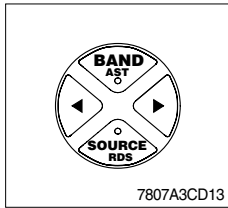

① CD playback

This CD player is suitable only for 12cm disc, do not use irregular shaped CD.

- Slide the disc into the slot with label facing upwards. Playback starts.
- If a disc is already inserted :
Press SOURCE to select CD as the source.
Playback starts.

② Previous / Next track(◀ or ▶)

- Short press the ◀ or ▶ button to select the desired track.
- Playback resume with the chosen track.

③ Fast rewind / Fast forward(◀◀ or ▶▶)

- Long press the ◀◀ or ▶▶ button for more than 2 seconds to quickly move rewind or forward through the disc.
- Normal play back resumes when you release the button.

④ Random track playback

- Press RND to activate / deactivate random track playback.

⑤ Repeat track

- Press RPT to activate / deactivate repeat current track.

⑥ Scan track

The scan function enables you to listen to the first few seconds of each track.

- Press SCN to activate / deactivate scan track.

⑦ Disc eject

- Press ▲ to eject the disc.

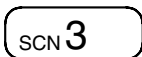
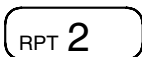
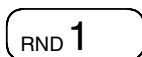

■ RADIO SETTING

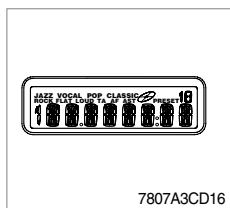

(1) AMERICA

Press , No. 1 and No. 4 buttons at the same time. Set up completes displaying " AMERICA".

(2) SOUTH AMERICA

Press , No. 2 and No. 5 buttons at the same time. Set up completes displaying " SOUTH".

(3) ASIA

Press , No. 1 and No. 5 buttons at the same time. Set up completes displaying " ASIA".

(4) EUROPE

Press power, No. 2 and No. 4 buttons at the same time. Set up completes displaying " EUROP".

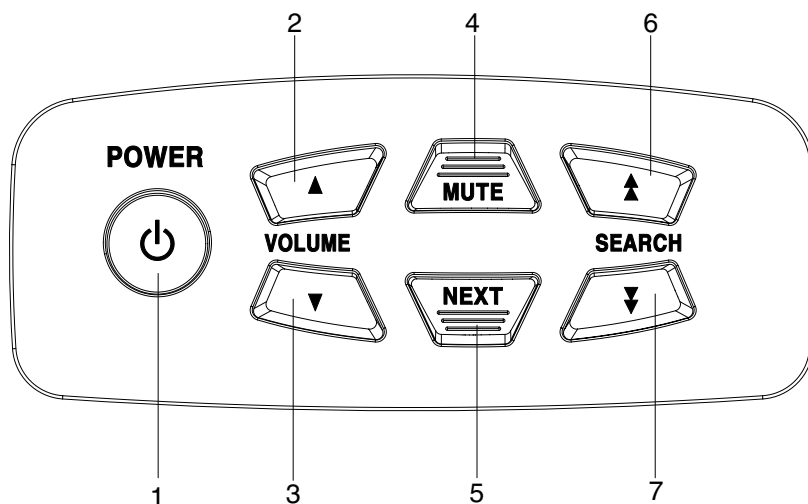

14) REMOTE CONTROLLER

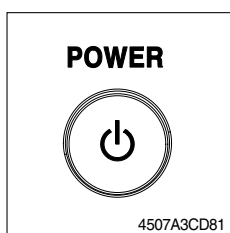

4507A3CD90

(1) Power ON/OFF button



① Press  to switch ON the set. Press  for more than 2seconds to switch OFF the set.

(2) Volume button(up)

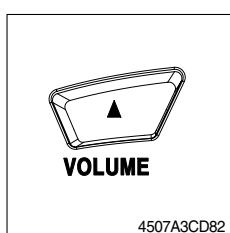

- Short press : Volume up one step
- Long press : Volume up continuous

(3) Volume button(down)

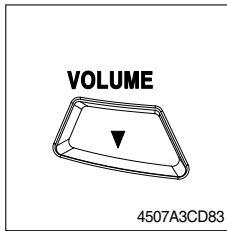

- Short press : Volume down one step
- Long press : Volume down continuous.

(4) Source & mute button



- Short press : Change source(Radio/CD)
- Long press : To mute or cancel mute.

(5) Next button

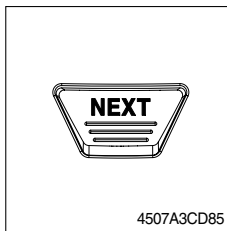

- ① Tuner mode
 - Short press : Preset up
 - Long press : Band up
- ② Cassette mode
 - Short press : Reverse(before the end of the tape)
 - Long press : No function
- ③ CD mode
 - Short press : Track 1
 - Long press : Scan track

(6) Search button(up)

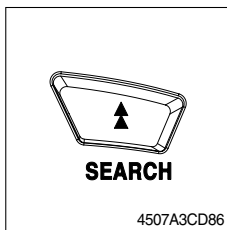

- ① Tuner mode
 - Short press : Search up one step
 - Long press : Search up continuous
- ② Cassette & CD mode
 - Short press : Next track
 - Long press : Fast forward

(7) Search button(down)

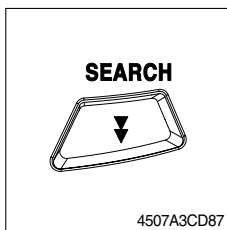

- ① Tuner mode
 - Short press : Search down one step
 - Long press : Search down continuous
- ② Cassette & CD mode
 - Short press : Previous track
 - Long press : Fast rewind