

# SPECIFICATIONS

## 1. MAJOR COMPONENT

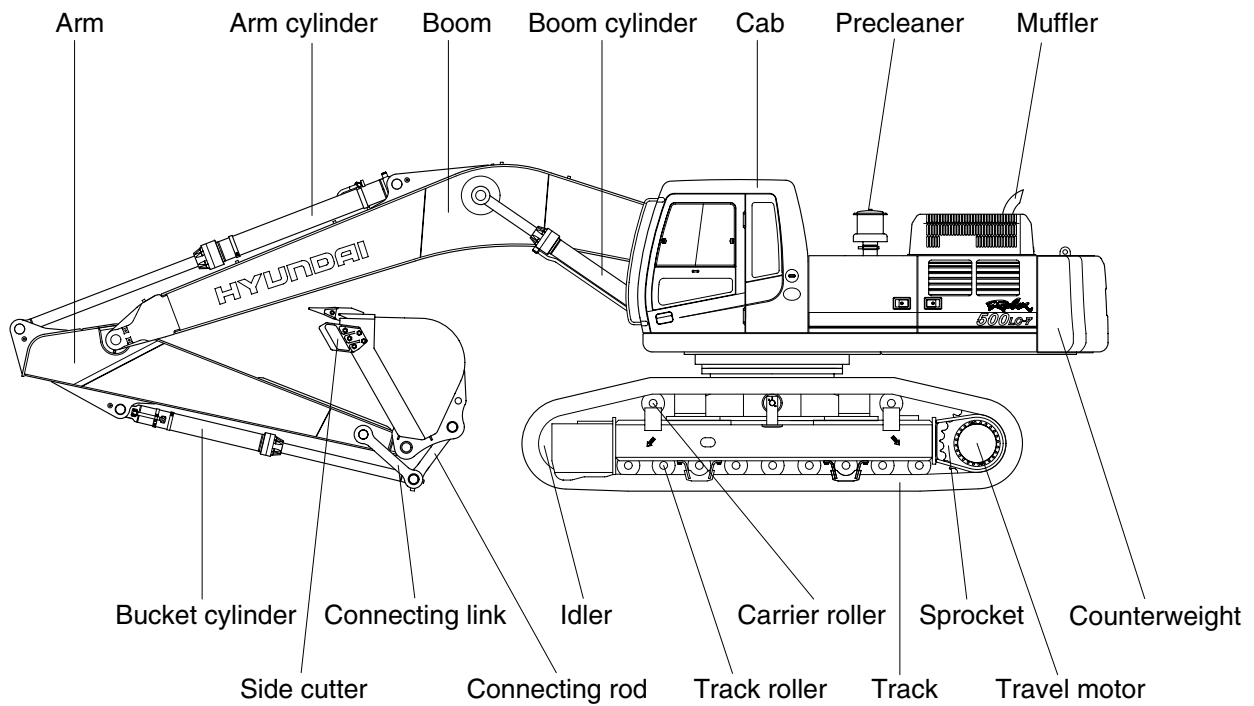
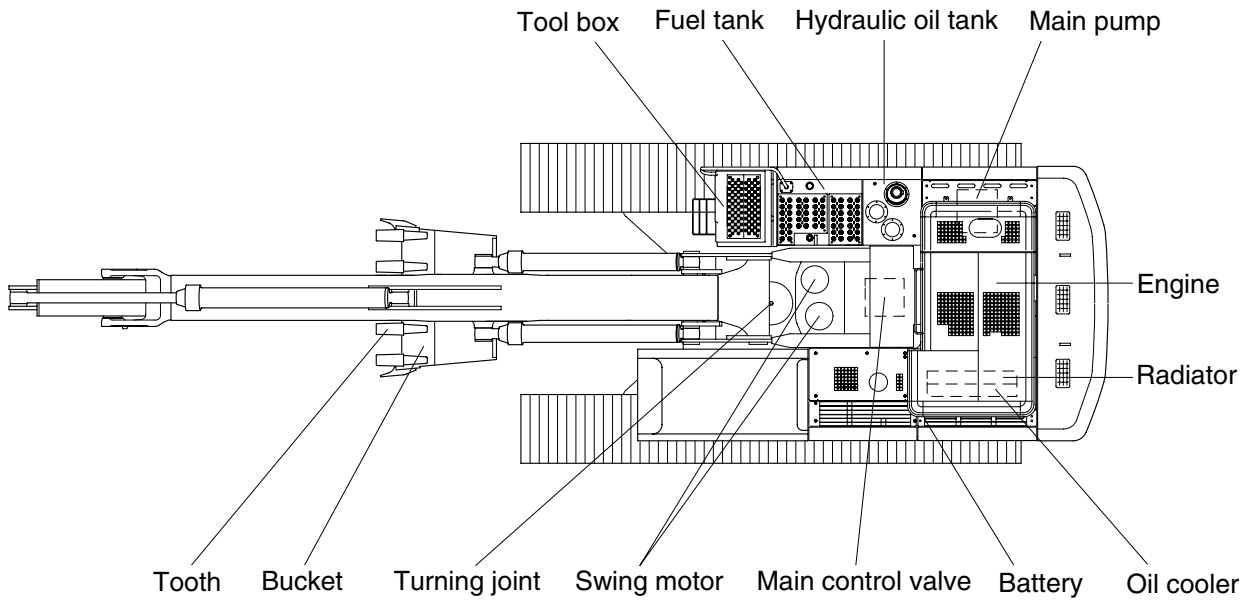

50072SP00

## 2. SPECIFICATIONS

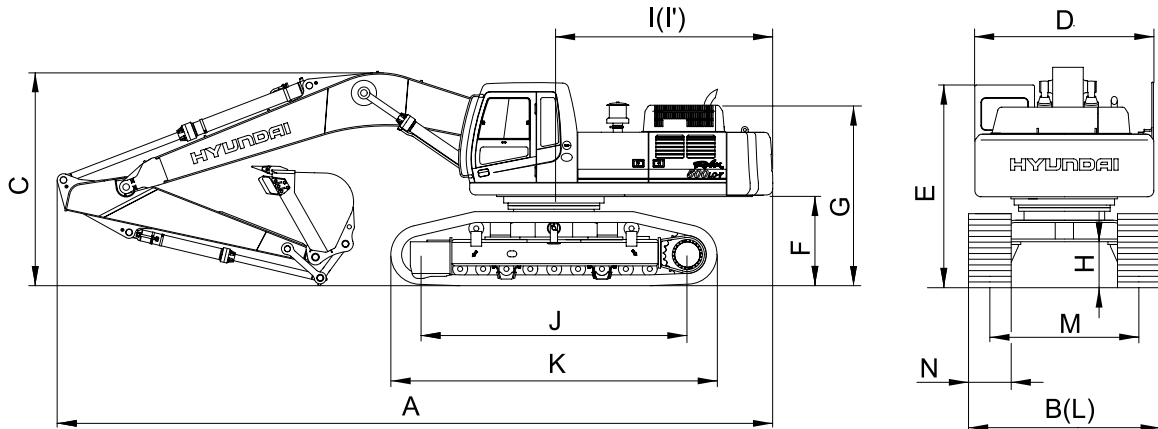

50072SP02

Description		Unit	Specification
Operating weight		kg(lb)	48800(107580)
Bucket capacity(SAE heaped), standard		m <sup>3</sup> (yd <sup>3</sup> )	2.15(2.81)
Overall length	A	mm(ft-in)	11980(39' 4")
Overall width, with 600mm shoe (Transport position/Working position)	B		2990/3540(9'10"/11'7")
Overall height	C		3670(12' 0")
Superstructure width	D		2980( 9' 9")
Overall height of cab	E		3390(11' 1")
Ground clearance of counterweight	F		1500( 4'11")
Engine cover height	G		3015( 9'11")
Minimum ground clearance	H		770( 2' 6")
Rear-end distance	I		3665(12' 0")
Rear-end swing radius	I'		3720(12' 2")
Distance between tumbler	J		4470(14' 8")
Undercarriage length	K		5460(17'11")
Undercarriage width (Transport position/Working position)	L		2990/3540(9'10"/11' 7")
Track gauge (Transport position/Working position)	M		2380/2940( 7'10"/ 9' 8')
Track shoe width, standard	N		600(24")
Travel speed(Low/high)		km/hr(mph)	3.3/5.2(2.0/3.2)
Swing speed		rpm	10.0
Gradeability		Degree(%)	35(70)
Ground pressure(600mm shoe)		kgf/cm <sup>2</sup> (psi)	0.86(12.2)

### 3. WORKING RANGE

- 7.06m(23' 2") BOOM

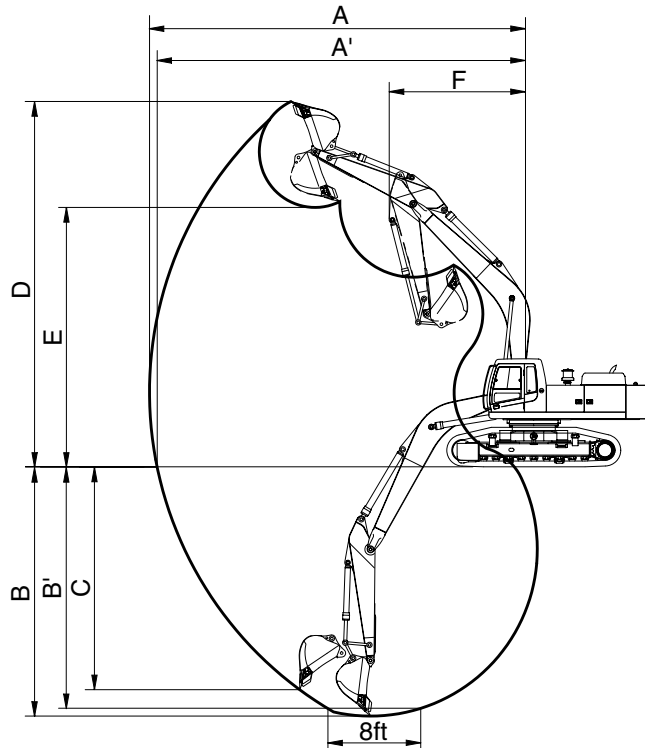

500072SP04

Description		2.40m(7'10") Arm	2.90m(9' 6") Arm	3.38m(11' 1") Arm	4.00m(13' 1") Arm	4.50m(14' 9") Arm
Max digging reach	A	11160mm (36' 7")	11550mm (37'11")	12100mm (39' 8")	12660mm (41' 6")	13150mm (43' 2")
Max digging reach on ground	A'	10900mm (35' 9")	11310mm (37' 1")	11870mm (38'11")	12440mm (40'10")	12930mm (42' 5")
Max digging depth	B	6630mm (21' 9")	7130mm (23' 5")	7610mm (24'12")	8230mm (27' 0")	8730mm (28' 8")
Max digging depth (8ft level)	B'	6450mm (21' 2")	6970mm (22'10")	7460mm (24' 6")	8100mm (26' 7")	8610mm (28' 3")
Max vertical wall digging depth	C	5810mm (19' 1")	5670mm (18' 7")	6380mm (20'11")	7120mm (23' 4")	7510mm (24' 8")
Max digging height	D	10690mm (35' 1")	10640mm (34'11")	11120mm (36' 6")	11330mm (37' 2")	11580mm (37'12")
Max dumping height	E	7270mm (23'10")	7330mm (24' 1")	7750mm (25' 5")	7960mm (26' 1")	8210mm (26'11")
Min swing radius	F	5090mm (16' 8")	4900mm (16' 1")	4780mm (15' 8")	4830mm (15'10")	4870mm (15'12")
Bucket digging force	SAE	246.2[268.5] kN	246.2[268.5] kN	246.2[268.5] kN	246.2[268.5] kN	246.2[268.5] kN
		25100[27380] kgf	25100[27380] kgf	25100[27380] kgf	25100[27380] kgf	25100[27380] kgf
		55340[60370] lbf	55340[60370] lbf	55340[60370] lbf	55340[60370] lbf	55340[60370] lbf
	ISO	292.2[318.8] kN	292.2[318.8] kN	292.2[318.8] kN	292.2[318.8] kN	292.2[318.8] kN
		29800[32510] kgf	29800[32510] kgf	29800[32510] kgf	29800[32510] kgf	29800[32510] kgf
		65700[71670] lbf	65700[71670] lbf	65700[71670] lbf	65700[71670] lbf	65700[71670] lbf
Arm crowd force	SAE	273.6[298.5] kN	222.6[242.9] kN	186.3[203.3] kN	169.7[185.1] kN	157.9[172.2] kN
		27900[30440] kgf	22700[24760] kgf	19000[20730] kgf	17300[18870] kgf	16100[17560] kgf
		61510[67100] lbf	50040[54590] lbf	41890[45700] lbf	38140[41610] lbf	35490[38720] lbf
	ISO	291.3[317.7] kN	235.4[256.8] kN	196.1[214.0] kN	177.5[193.6] kN	164.8[179.7] kN
		29700[32400] kgf	24000[26180] kgf	20000[21820] kgf	18100[19750] kgf	16800[18330] kgf
		65480[71430] lbf	52910[57720] lbf	44090[48100] lbf	39900[43530] lbf	37040[40410] lbf

[ ] : Power boost

· 6.55m(21' 6") BOOM

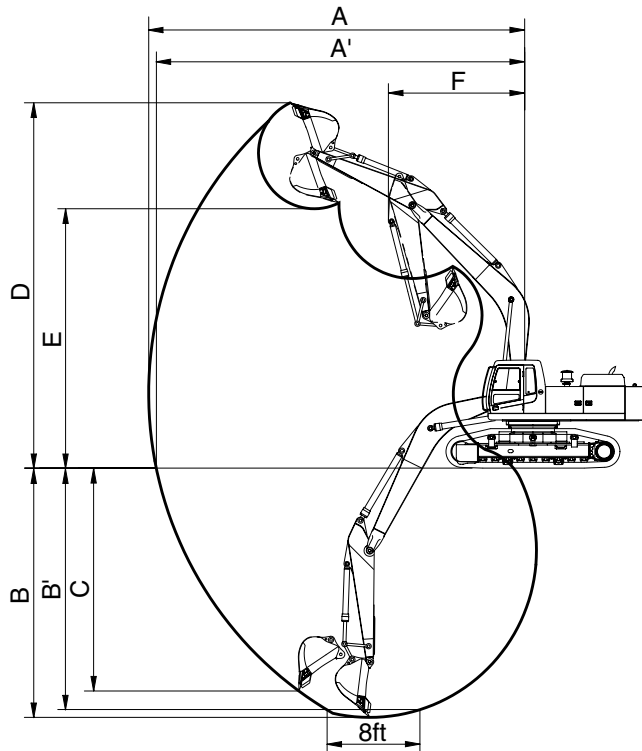

500072SP04

Description		2.40m(7' 10") Arm
Max digging reach	A	10610mm (34'10")
Max digging reach on ground	A'	10340mm (33'11")
Max digging depth	B	6150mm (20' 2")
Max digging depth (8ft level)	B'	5970mm (19' 7")
Max vertical wall digging depth	C	5250mm (17' 3")
Max digging height	D	10300mm (33'10")
Max dumping height	E	6900mm (22' 8")
Min swing radius	F	4640mm (15' 3")
Bucket digging force	SAE	246.2[268.5] kN
		25100[27380] kgf
		55340[60370] lbf
	ISO	292.2[318.8] kN
		29800[32510] kgf
		65700[71670] lbf
Arm crowd force	SAE	273.6[298.5] kN
		27900[30440] kgf
		61510[67100] lbf
	ISO	291.3[317.7] kN
		29700[32400] kgf
		65480[71430] lbf

[ ] : Power boost

- 9.00m(29' 6") BOOM

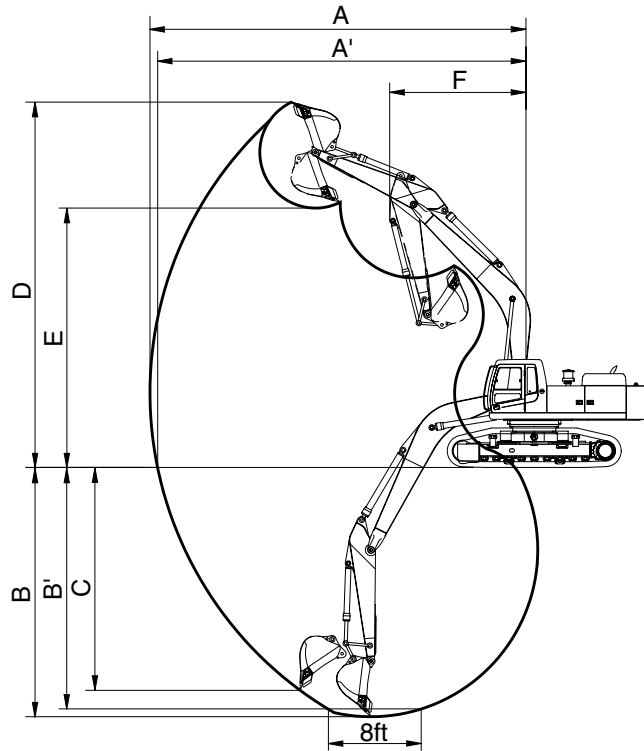

500072SP04

Description		5.85m(19' 2") Arm
Max digging reach	A	16280mm (53' 5")
Max digging reach on ground	A'	16100mm (52'10")
Max digging depth	B	11380mm (37' 4")
Max digging depth (8ft level)	B'	11280mm (37' 0")
Max vertical wall digging depth	C	10070mm (33' 0")
Max digging height	D	13930mm (45' 8")
Max dumping height	E	10530mm (34' 7")
Min swing radius	F	5940mm (19' 6")
Bucket digging force	SAE	251.1[273.9] kN
		25600[27930] kgf
		56440[61570] lbf
	ISO	296.2[323.1] kN
		30200[32950] kgf
		66580[72630] lbf
Arm crowd force	SAE	126.5[138.0] kN
		12900[14070] kgf
		28440[31030] lbf
	ISO	130.4[142.3] kN
		13300[14510] kgf
		29320[31990] lbf

[ ] : Power boost

## 4. WEIGHT











Item	R500LC-7	
	kg	lb
Upperstructure assembly	24540	54100
Main frame weld assembly	3550	7830
Engine assembly	940	2070
Main pump assembly	180	400
Main control valve assembly	420	930
Swing motor assembly	230	510
Hydraulic oil tank assembly	450	990
Fuel tank assembly	250	550
Counterweight	10200	22500
Cab assembly	310	680
Center frame support	8070	17790
Lower chassis assembly	15200	33510
Lower track frame	2130	4700
Swing bearing	600	1320
Travel motor assembly	360	790
Turning joint	50	110
Track recoil spring and idler	300	660
Idler	250	550
Carrier roller	80	180
Track roller	80	180
Track-chain assembly(600mm standard triple grouser shoe)	6050	13330
Front attachment assembly(7.06m boom, 3.38m arm, 2.15m <sup>3</sup> SAE heaped bucket)	10160	22400
7.06m boom assembly	3300	7360
3.38m arm assembly	1450	3200
2.15m <sup>3</sup> SAE heaped bucket	2540	5600
Boom cylinder assembly	910	2010
Arm cylinder assembly	540	1190
Bucket cylinder assembly	300	660
Bucket control rod assembly	130	290

## 5. LIFTING CAPACITIES

1) 6.55m(21' 6") boom, 2.40m(7'10") arm equipped with 2.15m<sup>3</sup>(SAE heaped) bucket, 600mm (24") triple grouser shoe and 10,200kg(22,490lb) counterweight.













•  : Rating over-front

•  : Rating over-side or 360 degree













Load point height		Load radius								At max. reach		
		3.0m(10.0ft)		4.5m(15.0ft)		6.0m(20.0ft)		7.5m(25.0ft)		Capacity		Reach
												m(ft)
7.5m (25.0ft)	kg lb									*10040 *22130	8720 19220	8.44 (27.7)
6.0m (20.0ft)	kg lb					*13190 *29080	*13190 *29080	*11580 *25530	10370 22860	*9900 *21830	7260 16010	9.23 (30.3)
4.5m (15.0ft)	kg lb			*19750 *43540	*19750 *43540	*14810 *32650	14470 31900	*12280 *27070	10050 22160	*9900 *21830	6490 14310	9.69 (31.8)
3.0m (10.0ft)	kg lb					*16480 *36330	13650 30090	*13090 *28860	9650 21270	9840 21690	6140 13540	9.86 (32.3)
1.5m (5.0ft)	kg lb					*17540 *38670	13010 28680	*13650 *30090	9290 20480	9870 21760	6120 13490	9.77 (32.1)
Ground Line	kg lb			*23620 *52070	19860 43780	*17620 *38850	12670 27930	*13660 *30120	9070 20000	*9950 *21940	6460 14240	9.41 (30.9)
-1.5m (-5.0ft)	kg lb	*26210 *57780	*26210 *57780	*21590 *47600	19950 43980	*16590 *36570	12600 27780	*12760 *28130	9020 19890	*9650 *21270	7310 16120	8.72 (28.6)
-3.0m (-10.0ft)	kg lb	*22070 *48660	*22070 *48660	*18190 *40100	*18190 *40100	*14140 *31170	12780 28180			*8660 *19090	*8660 *19090	7.62 (25.0)
-4.5m (-15.0ft)	kg lb			*12430 *27400	*12430 *27400							

- Note
1. Lifting capacity are based on SAE J1097 and ISO 10567.
  2. Lifting capacity of the ROBEX series does not exceed 75% of tipping load with the machine on firm, level ground or 87% of full hydraulic capacity.
  3. The load point is a hook located on the back of the bucket.
  4. \*indicates load limited by hydraulic capacity.















2) 7.06m(23' 2") boom, 2.40m(7' 10") arm equipped with 2.15m<sup>3</sup>(SAE heaped) bucket, 600mm (24") triple grouser shoe and 10,200kg(22,490lb) counterweight.

Load point height		Load radius										At max. reach		
		3.0m(10.0ft)		4.5m(15.0ft)		6.0m(20.0ft)		7.5m(25.0ft)		9.0m(30.0ft)		Capacity		Reach
														m(ft)
7.5m (25.0ft)	kg lb							*10410 *22950	*10410 *22950			*9050 *19950	7490 16510	9.09 (29.8)
6.0m (20.0ft)	kg lb					*12670 *27930	*12670 *27930	*10880 *23990	10210 22510			*8960 *19750	6330 13960	9.83 (32.3)
4.5m (15.0ft)	kg lb					*14410 *31770	14010 30890	*11710 *25820	9790 21580	*10160 *22400	7140 15740	*8960 *19750	5700 12570	10.26 (33.7)
3.0m (10.0ft)	kg lb					*16080 *35450	13100 28880	*12580 *27730	9330 20570	*10530 *23210	6930 15280	8810 19420	5400 11900	10.42 (34.2)
1.5m (5.0ft)	kg lb					*17070 *37630	12460 27470	*13200 *29100	8950 19730	*10770 *23740	6730 14840	8820 19440	5380 11860	10.33 (33.9)
Ground Line	kg lb					*17110 *37720	12160 26810	*13310 *29340	8720 19220			*9080 *20020	5650 12460	9.99 (32.8)
-1.5m (-5.0ft)	kg lb			*20730 *45700	19330 42620	*16250 *35830	12130 26740	*12710 *28020	8660 19090			*8900 *19620	6320 13930	9.36 (30.7)
-3.0m (-10.0ft)	kg lb	*20940 *46160	*20940 *46160	*17990 *39660	*17990 *39660	*14340 *31610	12310 27140	*10990 *24230	8810 19420			*8260 *18210	7720 17020	8.36 (27.4)
-4.5m (-15.0ft)	kg lb			*13590 *29960	*13590 *29960	*10660 *23500	*10660 *23500							















3) 7.06m(23' 2") boom, 2.90m(9' 6") arm equipped with 2.15m<sup>3</sup>(SAE heaped) bucket, 600mm (24") triple grouser shoe and 10,200kg(22,490lb) counterweight.

Load point height		Load radius										At max. reach		
		3.0m(10.0ft)		4.5m(15.0ft)		6.0m(20.0ft)		7.5m(25.0ft)		9.0m(30.0ft)		Capacity		Reach
														m(ft)
7.5m (25.0ft)	kg lb							*9660 *21300	*9660 *21300			*8360 *18430	6890 15190	9.55 (31.3)
6.0m (20.0ft)	kg lb							*10230 *22550	*10230 *22550			*8320 *18340	5880 12960	10.25 (33.6)
4.5m (15.0ft)	kg lb			*18360 *40480	*18360 *40480	*13580 *29940	*13580 *29940	*11140 *24560	9890 21800	*9690 *21360	7190 15850	*8380 *18470	5310 11710	10.66 (35.0)
3.0m (10.0ft)	kg lb			*22060 *48630	20430 45040	*15410 *33970	13270 29260	*12120 *26720	9380 20680	*10180 *22440	6930 15280	8260 18210	5030 11090	10.81 (35.5)
1.5m (5.0ft)	kg lb			*23550 *51920	19290 42530	*16670 *36750	12520 27600	*12880 *28400	8950 19730	*10550 *23260	6690 14750	8250 18190	5000 11020	10.73 (35.2)
Ground Line	kg lb			*23160 *51060	19000 41890	*17060 *37610	12110 26700	*13190 *29080	8650 19070	*10620 *23410	6530 14400	8620 19000	5210 11490	10.40 (34.1)
-1.5m (-5.0ft)	kg lb	*21420 *47220	*21420 *47220	*21740 *47930	19060 42020	*16540 *36460	11980 26410	*12870 *28370	8540 18830			*8630 *19030	5770 12720	9.80 (32.2)
-3.0m (-10.0ft)	kg lb	*24420 *53840	*24420 *53840	*19320 *42590	*19320 *42590	*15030 *33140	12090 26650	*11640 *25660	8600 18960			*8300 *18300	6900 15210	8.86 (29.1)
-4.5m (-15.0ft)	kg lb	*19000 *41890	*19000 *41890	*15480 *34130	*15480 *34130	*12100 *26680	*12100 *26680					*7100 *15650	*7100 *15650	7.42 (24.3)















4) 7.06m(23' 2") boom, 3.38m(11' 1") arm equipped with 2.15m<sup>3</sup>(SAE heaped) bucket, 600mm (24") triple grouser shoe and 10,200kg(22,490lb) counterweight.

Load point height		Load radius										At max. reach				
		3.0m(10.0ft)		4.5m(15.0ft)		6.0m(20.0ft)		7.5m(25.0ft)		9.0m(30.0ft)		Capacity		Reach		
																m(ft)
7.5m (25.0ft)	kg lb													*7870 *17350	6190 13650	10.18 (33.4)
6.0m (20.0ft)	kg lb							*9730 *21450	*9730 *21450	*8620 *19000	7560 16670	*7850 *17310	5370 11840	10.83 (35.5)		
4.5m (15.0ft)	kg lb			*17090 *37680	*17090 *37680	*12920 *28480	*12920 *28480	*10720 *23630	10070 22200	*9390 *20700	7330 16160	*7900 *17420	4890 10780	11.21 (36.8)		
3.0m (10.0ft)	kg lb			*21120 *46560	*21120 *46560	*14910 *32870	13590 29960	*11800 *26010	9560 21080	*9960 *21960	7060 15560	7660 16890	4660 10190	11.36 (37.3)		
1.5m (5.0ft)	kg lb			*23430 *51650	19850 43760	*16450 *36270	12800 28220	*12720 *28040	9100 20060	*10450 *23040	6790 14970	7650 16870	4620 10190	11.28 (37.0)		
Ground Line	kg lb	*13300 *29320	*13300 *29320	*23730 *52320	19310 42570	*17140 *37790	12310 27140	*13220 *29150	8770 19330	*10670 *23520	6590 14530	7950 17530	4800 10580	10.97 (36.0)		
-1.5m (-5.0ft)	kg lb	*19310 *42570	*19310 *42570	*22730 *50110	19220 42370	*16930 *37320	12100 26680	*13120 *28920	8600 18960	*10420 *22970	6500 14330	*8140 *17950	5250 11570	10.41 (34.2)		
-3.0m (-10.0ft)	kg lb	*25700 *56660	*25700 *56660	*20660 *45550	19390 42750	*15760 *34740	12120 26720	*12230 *26960	8600 18960			*7910 *17440	6130 13510	9.54 (31.3)		
-4.5m (-15.0ft)	kg lb	*22360 *49300	*22360 *49300	*17250 *38030	*17250 *38030	*13340 *29410	12360 27250	*9970 *21980	8820 19440			*7110 *15670	*7110 *15670	8.25 (27.1)		
-6.0m (-20.0ft)	kg lb			*11650 *25680	*11650 *25680											















5) 7.06m(23' 2") boom, 4.00m(13' 1") arm equipped with 2.15m<sup>3</sup>(SAE heaped) bucket, 600mm (24") triple grouser shoe and 10,200kg(22,490lb) counterweight.

Load point height		Load radius										At max. reach				
		3.0m(10.0ft)		4.5m(15.0ft)		6.0m(20.0ft)		7.5m(25.0ft)		9.0m(30.0ft)		10.5m(35.0ft)		Capacity		Reach
																m(ft)
7.5m (25.0ft)	kg lb									*6580 *14510	*6580 *14510			*7130 *15720	5520 12170	10.81 (35.5)
6.0m (20.0ft)	kg lb									*8200 *18080	7640 16840			*7150 *15760	4820 10630	11.42 (37.5)
4.5m (15.0ft)	kg lb							*9910 *21850	*9910 *21850	*8760 *19310	7370 16250	*5530 *12190	5470 12060	*7220 *15920	4410 9720	11.78 (38.6)
3.0m (10.0ft)	kg lb			*19310 *42570	*19310 *42570	*13880 *30600	13790 30400	*11090 *24450	9620 21210	*9420 *20770	7060 15560	*7170 *15810	5310 11710	7000 15430	4190 9240	11.92 (39.1)
1.5m (5.0ft)	kg lb			*22370 *49320	20130 44380	*15680 *34570	12890 28420	*12150 *26790	9100 20060	*10030 *22110	6750 14880	*7960 *17550	5140 11330	6980 15390	4150 9150	11.85 (38.9)
Ground Line	kg lb	*13920 *30690	*13920 *30690	*23510 *51830	19280 42510	*16730 *36880	12270 27050	*12860 *28350	8710 19200	*10410 *22950	6510 14350	*7220 *15920	5010 11050	7210 15900	4290 9460	11.56 (37.9)
-1.5m (-5.0ft)	kg lb	*18330 *40410	*18330 *40410	*23140 *51010	18990 41870	*16900 *37260	11960 26370	*13030 *28730	8470 18670	*10410 *22950	6360 14020			*7610 *16780	4640 10230	11.03 (36.2)
-3.0m (-10.0ft)	kg lb	*23530 *51870	*23530 *51870	*21600 *47620	19040 41980	*16150 *35600	11890 26210	*12500 *27560	8400 18520	*9760 *21520	6340 13980			*7540 *16620	5340 11770	10.21 (33.5)
-4.5m (-15.0ft)	kg lb	*25640 *56530	*25640 *56530	*18800 *41450	*18800 *41450	*14300 *31530	12050 26570	*10940 *24120	8520 18780					*7120 *15700	6670 14700	9.04 (29.7)
-6.0m (-20.0ft)	kg lb	*18550 *40900	*18550 *40900	*14200 *31310	*14200 *31310	*10730 *23660	*10730 *23660									

6) 7.06m(23' 2") boom, 4.50m(14' 9") arm equipped with 2.15m<sup>3</sup>(SAE heaped) bucket, 600mm (24") triple grouser shoe and 10,200kg(22,490lb) counterweight.

Load point height		Load radius												At max. reach		
		3.0m(10.0ft)		4.5m(15.0ft)		6.0m(20.0ft)		7.5m(25.0ft)		9.0m(30.0ft)		10.5m(35.0ft)		Capacity		Reach
																m(ft)
7.5m (25.0ft)	kg lb									*6900 *15210	*6900 *15210			*6590 *14530	4980 10980	11.35 (37.2)
6.0m (20.0ft)	kg lb									*7620 *16800	*7620 *16800	*5070 *11180	*5070 *11180	*6610 *14570	4370 9630	11.93 (39.1)
4.5m (15.0ft)	kg lb							*9230 *20350	*9230 *20350	*8220 *18120	7400 16310	*6810 *15010	5470 12060	*6680 *14730	4000 8820	12.27 (40.3)
3.0m (10.0ft)	kg lb			*17760 *39150	*17760 *39150	*12980 *28620	*12980 *28620	*10470 *23080	9670 21320	*8940 *19710	7050 15540	*7920 *17460	5270 11620	*6660 14240	3800 8380	12.40 (40.7)
1.5m (5.0ft)	kg lb			*21260 *46870	20360 44890	*14940 *32940	12950 28550	*11630 *25640	9100 20060	*9620 *21210	6710 14790	*8270 *18230	5070 11180	6430 14180	3760 8290	12.33 (40.5)
Ground Line	kg lb	*14070 *31020	*14070 *31020	*23000 *50710	19220 42370	*16240 *35800	12220 26940	*12470 *27490	8630 19030	*10120 *22310	6420 14150	8270 18230	4910 10820	6620 14590	3860 8510	12.06 (39.6)
-1.5m (-5.0ft)	kg lb	*17560 *38710	*17560 *38710	*23140 *51010	18750 41340	*16700 *36820	11800 26010	*12830 *28290	8330 18360	*10280 *22660	6230 13730	*7920 *17460	4810 10600	7080 15610	4160 9170	11.55 (37.9)
-3.0m (-10.0ft)	kg lb	*22030 *48570	*22030 *48570	*22050 *48610	18680 41180	*16270 *35870	11650 25680	*12550 *27670	8210 18100	*9900 *21830	6160 13580			*7100 *15650	4720 10410	10.79 (35.4)
-4.5m (-15.0ft)	kg lb	*27690 *61050	*27690 *61050	*19730 *43500	18900 41670	*14820 *32670	11740 25880	*11390 *25110	8260 18210	*8530 *18810	6260 13800			*6850 *15100	5780 12740	9.69 (31.8)
-6.0m (-20.0ft)	kg lb	*21410 *47200	*21410 *47200	*15800 *34830	*15800 *34830	*11940 *26320	*11940 *26320	*8660 *19090	8560 18870					*5940 *13100	*5940 *13100	8.10 (26.6)

7) 9.00m(29' 6") boom, 5.85m(19' 2") arm equipped with 1.65m<sup>3</sup>(SAE heaped) bucket, 600mm (24") triple grouser shoe and 10,200kg(22,490lb) counterweight.

Load point height		Load radius												At max. reach		
		3.0m(10.0ft)		5.0m(15.0ft)		7.0m(25.0ft)		9.0m(30.0ft)		11.0m(35.0ft)		13.0m(45.0ft)		Capacity		Reach
																m(ft)
10.0m (35.0ft)	kg lb													*4350 *9590	3530 7780	13.66 (44.8)
8.0m (25.0ft)	kg lb									*4910 *10820	*4910 *10820	*2810 *6190	*2810 *6190	*4290 *9460	2860 6310	14.63 (48.0)
6.0m (20.0ft)	kg lb									*5320 *11730	*5320 *11730	*4370 *9630	3650 8050	*4290 *9460	2450 5400	15.25 (50.0)
4.0m (15.0ft)	kg lb					*9040 *19930	*9040 *19930	*7050 *15540	*7050 *15540	*5880 *12960	4990 11000	*5110 *11270	3450 7610	4200 9260	2200 4850	15.57 (51.1)
2.0m (-5.0ft)	kg lb			*16870 *37190	16620 36640	*10900 *24030	9970 21980	*8070 *17790	6630 14620	*6460 14240	4600 10140	*5410 *11930	3230 7120	4080 8990	2100 4630	15.60 (51.2)
Ground Line	kg lb			*17270 *38070	15020 33110	*12210 *26920	9020 19890	*8880 *19580	6060 13360	*6930 *15280	4250 9370	5550 12240	3030 6680	4140 9130	2110 4650	15.35 (50.4)
-2.0m (-5.0ft)	kg lb	*11700 *25790	*11700 *25790	*18210 *40150	14440 31830	*12720 *28040	8480 18700	*9290 *20480	5680 12520	*7160 *15790	4010 8840	5400 11900	2890 6370	4390 9680	2270 5000	14.80 (48.6)
-4.0m (-15.0ft)	kg lb	*15000 *33070	*15000 *33070	*17860 *39370	14390 31720	*12450 *27450	8290 18280	*9180 *20240	5500 12130	*7000 *15430	3890 8580	*4190 *9240	2870 6330	*4530 *9990	2620 5780	13.91 (45.6)
-6.0m (-20.0ft)	kg lb	*18860 *41580	*18860 *41580	*15810 *34860	14660 32320	*11330 *24980	8360 18430	*8400 *18520	5530 12190	*6190 *13650	3940 8690			*4380 *9660	3290 7250	12.61 (41.4)
-8.0m (-25.0ft)	kg lb	*17900 *39460	*17900 *39460	*12440 *27430	*12440 *27430	*9090 *20040	8680 19140	*6540 *14420	5780 12740					*3820 *8420	*3820 *8420	10.72 (35.2)

## 6. BUCKET SELECTION GUIDE

### 1) GENERAL BUCKET

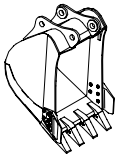
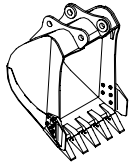
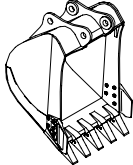
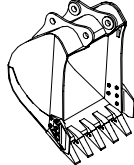
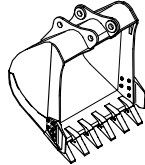
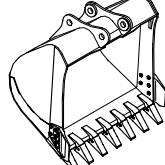
					
1.38m³ SAE ★1.38m³ SAE 1.65m³ SAE heaped bucket	★1.65m³ SAE 1.84m³ SAE heaped bucket	※2.15m³ SAE heaped bucket	2.56m³ SAE 2.79m³ SAE heaped bucket	3.03m³ SAE heaped bucket	3.20m³ SAE 3.60m³ SAE heaped bucket

Capacity		Width		Weight	Recommendation							
SAE heaped	CECE heaped	Without side cutter	With side cutter		7.06m (23' 2") boom					6.55m(21'5") boom	9.00m(29'6") boom	
					2.4m arm (7' 10")	2.9m arm (9' 6")	3.38m arm (11' 1")	4.0m arm (13' 1")	4.5m arm (14' 9")	2.4m arm (7' 10")	5.85m arm (19' 2")	
1.38m³ (1.80yd³)	1.25m³ (1.63yd³)	995mm (39.2")	1145mm (45.1")	1420kg (3130lb)								
1.65m³ (2.16yd³)	1.48m³ (1.94yd³)	1140mm (44.9")	1290mm (50.8")	1520kg (3350lb)								
1.84m³ (2.41yd³)	1.65m³ (2.16yd³)	1245mm (49.0")	1395mm (54.9")	1630kg (3590lb)								
※2.15m³ (2.81yd³)	1.892m³ (2.51yd³)	1415mm (55.7")	1565mm (61.6")	1740kg (3840lb)								
2.56m³ (3.35yd³)	2.27m³ (2.97yd³)	1635mm (64.4")	1785mm (70.3")	1870kg (4120lb)								
2.79m³ (3.65yd³)	2.47m³ (3.23yd³)	1760mm (69.3")	1910mm (75.2")	1960kg (4320lb)								
3.03m³ (3.96yd³)	2.67m³ (3.49yd³)	1890mm (74.4")	2040mm (80.3")	2090kg (4610lb)								
3.20m³ (4.19yd³)	2.82m³ (3.69yd³)	1980mm (78.0")	2130mm (83.9")	2205kg (4860lb)								
3.60m³ (4.71yd³)	3.17m³ (4.15yd³)	2200mm (86.6")	2350mm (92.5")	2395kg (5280lb)								
★1.38m³ (1.80yd³)	1.20m³ (1.57yd³)	1100mm (43.3")	1250mm (49.2")	1360kg (3000lb)								
★1.65m³ (2.16yd³)	1.44m³ (1.88yd³)	1350mm (53.1")	1500mm (59.1")	1550kg (3420lb)								

※ : Standard bucket, ★ : 9.00m Boom, 5.85m Arm only

 Applicable for materials with density of 2000kgf/m³ (3370lbf/yd³) or less

 Applicable for materials with density of 1600kgf/m³ (2700lbf/yd³) or less

 Applicable for materials with density of 1100kgf/m³ (1850lbf/yd³) or less

## 2) ROCK AND HEAVY DUTY BUCKET

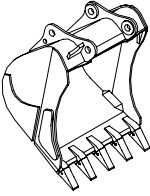
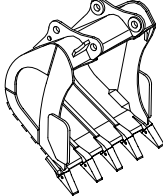
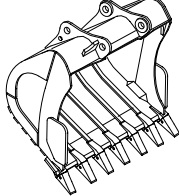
		
◆ 2.2m <sup>3</sup> SAE heaped bucket	⊙ 1.8m <sup>3</sup> SAE ⊙ 2.2m <sup>3</sup> SAE ⊙ 2.43m <sup>3</sup> SAE heaped bucket	⊙ 3.20m <sup>3</sup> SAE heaped bucket

Capacity		Width		Weight	Recommendation						
SAE heaped	CECE heaped	Without side cutter	With side cutter		7.06m (23' 2") boom					6.55m boom	
					2.4m arm (7' 10")	2.9m arm (9' 6")	3.38m arm (11' 1")	4.0m arm (13' 1")	4.5m arm (14' 9")		2.4m arm (7' 10")
◆2.20m <sup>3</sup> (2.88yd <sup>3</sup> )	1.80m <sup>3</sup> (2.35yd <sup>3</sup> )	1840mm (71.3")	-	2170kg (4780lb)							
⊙1.80m <sup>3</sup> (2.35yd <sup>3</sup> )	1.50m <sup>3</sup> (1.96yd <sup>3</sup> )	1560mm (61.4")	-	2090kg (4610lb)							
⊙2.20m <sup>3</sup> (2.88yd <sup>3</sup> )	1.80m <sup>3</sup> (2.35yd <sup>3</sup> )	1835mm (72.2")	-	2295kg (5060lb)							
⊙2.43m <sup>3</sup> (3.18yd <sup>3</sup> )	2.10m <sup>3</sup> (2.75yd <sup>3</sup> )	1885mm (74.2")	-	2335kg (5150lb)							
⊙3.20m <sup>3</sup> (4.19yd <sup>3</sup> )	2.80m <sup>3</sup> (3.66yd <sup>3</sup> )	2095mm (82.5")	-	2900kg (6390lb)							

◆ : Heavy duty bucket

⊙ : Rock bucket

 Applicable for materials with density of 2000kgf/m<sup>3</sup> (3370lbf/yd<sup>3</sup>) or less

 Applicable for materials with density of 1600kgf/m<sup>3</sup> (2700lbf/yd<sup>3</sup>) or less

 Applicable for materials with density of 1100kgf/m<sup>3</sup> (1850lbf/yd<sup>3</sup>) or less

## 7. UNDERCARRIAGE

### 1) TRACKS

X-leg type center frame is integrally welded with reinforced box-section track frames. The design includes dry tracks, lubricated rollers, idlers, sprockets, hydraulic track adjusters with shock absorbing springs and assembled track-type tractor shoes with triple grousers.

### 2) TYPES OF SHOES

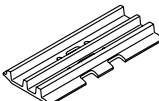
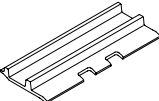
Model	Shapes		Triple grouser				Double grouser	
								
R500LC-7	Shoe width	mm(in)	600(24)	700(28)	750(30)	800(32)	600(24)	700(28)
	Operating weight	kg(lb)	48800(107580)	49340(108770)	49590(109330)	49850(109900)	48800(107580)	49340(108770)
	Ground pressure	kgf/cm <sup>2</sup> (psi)	0.84(11.94)	0.73( 10.38)	0.69( 9.81)	0.65( 9.24)	0.84( 11.94)	0.73( 10.38)
	Overall width	mm(ft-in)	3540(11' 7")	3640(11' 11")	3690(12' 1")	3740(12' 3")	3540(11' 7")	3640(11' 11")

### 3) NUMBER OF ROLLERS AND SHOES ON EACH SIDE

Item	Quantity
Carrier rollers	3EA
Track rollers	9EA
Track shoes	53EA

### 4) SELECTION OF TRACK SHOE

Suitable track shoes should be selected according to operating conditions.

#### Method of selecting shoes

Confirm the category from the list of applications in **table 2**, then use **table 1** to select the shoe. Wide shoes(Categories B and C) have limitations on applications. Before using wide shoes, check the precautions, then investigate and study the operating conditions to confirm if these shoes are suitable.

Select the narrowest shoe possible to meet the required flotation and ground pressure. Application of wider shoes than recommendations will cause unexpected problem such as bending of shoes, crack of link, breakage of pin, loosening of shoe bolts and the other various problems.

※ **Table 1**

Track shoe	Specification	Category
600mm triple grouser	Standard	A
600mm double grouser	Option	A
700mm triple grouser, double grouser	Option	B
750mm triple grouser	Option	B
800mm triple grouser	Option	C

※ **Table 2**

Category	Applications	Precautions
A	Rocky ground, river beds, normal soil	<ul style="list-style-type: none"> <li>• Travel at low speed on rough ground with large obstacles such as boulders or fallen trees</li> </ul>
B	Normal soil, soft ground	<ul style="list-style-type: none"> <li>• These shoes cannot be used on rough ground with large obstacles such as boulders or fallen trees</li> <li>• Travel at high speed only on flat ground</li> <li>• Travel slowly at low speed if it is impossible to avoid going over obstacles</li> </ul>
C	Extremely soft ground (Swampy ground)	<ul style="list-style-type: none"> <li>• Use the shoes only in the conditions that the machine sinks and it is impossible to use the shoes of category A or B</li> <li>• These shoes cannot be used on rough ground with large obstacles such as boulders or fallen trees</li> <li>• Travel at high speed only on flat ground</li> <li>• Travel slowly at low speed if it is impossible to avoid going over obstacles</li> </ul>

## 8. SPECIFICATIONS FOR MAJOR COMPONENTS

### 1) ENGINE

Item	Specification
Model	Cummins QSM 11
Type	4-cycle turbocharged diesel engine
Cooling method	Water cooling
Number of cylinders and arrangement	6 cylinders, in-line
Firing order	1-5-3-6-2-4
Combustion chamber type	Direct injection type
Cylinder bore × stroke	125 × 147.1mm(4.92" × 5.79")
Piston displacement	10800cc(505cu in)
Compression ratio	16.3 : 1
Rated gross horse power(SAE J1995)	358ps at 1900rpm(353Hp / 263kW at 1900rpm)
Maximum torque	182.5kgf · m(1320lb · ft) at 1300rpm
Engine oil quantity	37.85 l (10U.S. gal)
Dry weight	942kg(2077lb)
High idling speed	1950 ± 50rpm
Low idling speed	800 ± 50rpm
Rated fuel consumption	144g/Hp · hr at 1900rpm
Starting motor	Delco remy 42MT (24V-7.2kW)
Alternator	Delco Remy 24V-50A
Battery	2 × 12V × 160Ah

### 2) MAIN PUMP

Item	Specification
Type	Variable displacement tandem axis piston pumps
Capacity	2 × 200cc/rev
Maximum pressure	330kgf/cm <sup>2</sup> (4690psi)[360kgf/cm <sup>2</sup> (5120psi)]
Rated oil flow	2 × 380 l /min (100.4U.S. gpm/83.6U.K. gpm)
Rated speed	1900rpm

[ ]: Power boost

### 3) GEAR PUMP

Item	Specification
Type	Fixed displacement gear pump single stage
Capacity	15cc/rev
Maximum pressure	35kgf/cm <sup>2</sup> (498psi)
Rated oil flow	28.5 l /min(7.5U.S. gpm/6.3U.K. gpm)

### 4) MAIN CONTROL VALVE

Item	Specification
Type	9 spools
Operating method	Hydraulic pilot system
Main relief valve pressure	330kgf/cm <sup>2</sup> (4690psi) [360kgf/cm <sup>2</sup> (5120psi)]
Overload relief valve pressure	380kgf/cm <sup>2</sup> (5400psi)

[ ]: Power boost

### 5) SWING MOTOR

Item	Specification
Type	Fixed displacement axial piston motor
Capacity	148.5cc/rev
Relief pressure	285kgf/cm <sup>2</sup> (4050psi)
Braking system	Automatic, spring applied hydraulic released
Braking torque	63kgf · m(456lb · ft)
Brake release pressure	23~50kgf/cm <sup>2</sup> (327~711psi)
Reduction gear type	2 - stage planetary
Swing speed	10.0rpm

### 6) TRAVEL MOTOR

Item	Specification
Type	Variable displacement axial piston motor
Relief pressure	345kgf/cm <sup>2</sup> (4910psi)
Capacity(max / min)	160/100cc/rev
Reduction gear type	3-stage planetary
Braking system	Automatic, spring applied hydraulic released
Brake release pressure	17~50kgf/cm <sup>2</sup> (242~711psi)
Braking torque	103kgf · m(745lb · ft)

## 7) REMOTE CONTROL VALVE

Item		Specification
Type		Pressure reducing type
Operating pressure	Minimum	6.5kgf/cm <sup>2</sup> (92psi)
	Maximum	26kgf/cm <sup>2</sup> (370psi)
Single operation stroke	Lever	61mm(2.4in)
	Pedal	123mm(4.84in)

## 8) CYLINDER

Item		Specification
Boom cylinder	Bore dia × Rod dia × Stroke	∅ 170 × ∅ 115 × 1570mm
	Cushion	Extend only
Arm cylinder	Bore dia × Rod dia × Stroke	∅ 190 × ∅ 130 × 1820mm
	Cushion	Extend and retract
Bucket cylinder	Bore dia × Rod dia × Stroke	∅ 170 × ∅ 115 × 1370mm
	Cushion	Extend only

- ※ Discoloration of cylinder rod can occur when the friction reduction additive of lubrication oil spreads on the rod surface.
- ※ Discoloration does not cause any harmful effect on the cylinder performance.

## 9) SHOE

Item		Width	Ground pressure	Link quantity	Overall width
R500LC-7	Standard	★600mm(24")	0.86kgf/cm <sup>2</sup> (12.23psi)	53	3540mm(11' 7")
	Option	★700mm(28")	0.75kgf/cm <sup>2</sup> (10.67psi)	53	3640mm(11' 11")
		★750mm(30")	0.70kgf/cm <sup>2</sup> ( 9.96psi)	53	3690mm(12' 1")
		★800mm(32")	0.66kgf/cm <sup>2</sup> ( 9.39psi)	53	3740mm(12' 3")
		※ 600mm(24")	0.86kgf/cm <sup>2</sup> (12.23psi)	53	3540mm(11' 7")
		※ 700mm(28")	0.75kgf/cm <sup>2</sup> (10.67psi)	53	3640mm(11' 11")

- ★Triple grouser
- ※ Double grouser

## 10) BUCKET

Item		Capacity		Tooth quantity	Width	
		SAE heaped	CECE heaped		Without side cutter	With side cutter
R500LC-7	Standard	2.15m <sup>3</sup> (2.81yd <sup>3</sup> )	1.85m <sup>3</sup> (2.40yd <sup>3</sup> )	5	1610mm(63.4")	1760mm(69.3")
	Option	1.38m <sup>3</sup> (1.80yd <sup>3</sup> )	1.20m <sup>3</sup> (1.57yd <sup>3</sup> )	4	1100mm(43.3")	1250mm(49.2")
		1.65m <sup>3</sup> (2.16yd <sup>3</sup> )	1.44m <sup>3</sup> (1.88yd <sup>3</sup> )	5	1350mm(53.1")	1500mm(59.1")
		1.84m <sup>3</sup> (2.41yd <sup>3</sup> )	1.60m <sup>3</sup> (2.09yd <sup>3</sup> )	5	1420mm(55.9")	1570mm(61.8")
		2.56m <sup>3</sup> (3.35yd <sup>3</sup> )	2.20m <sup>3</sup> (2.90yd <sup>3</sup> )	6	1870mm(73.6")	2020mm(79.5")
		2.79m <sup>3</sup> (3.65yd <sup>3</sup> )	2.40m <sup>3</sup> (3.14yd <sup>3</sup> )	7	2020mm(79.5")	2170mm(85.4")
		3.03m <sup>3</sup> (3.96yd <sup>3</sup> )	2.60m <sup>3</sup> (3.40yd <sup>3</sup> )	7	2170mm(85.4")	2320mm(91.3")
		3.20m <sup>3</sup> (4.19yd <sup>3</sup> )	2.78m <sup>3</sup> (3.64yd <sup>3</sup> )	7	2030mm(79.9")	2180mm(85.8")
		3.60m <sup>3</sup> (4.71yd <sup>3</sup> )	3.15m <sup>3</sup> (4.12yd <sup>3</sup> )	7	2250mm(88.6")	2400mm(94.5")
		◆2.20m <sup>3</sup> (2.88yd <sup>3</sup> )	1.80m <sup>3</sup> (2.35yd <sup>3</sup> )	5	1810mm(71.3")	-
		◎1.80m <sup>3</sup> (2.35yd <sup>3</sup> )	1.50m <sup>3</sup> (1.96yd <sup>3</sup> )	5	1560mm(61.4")	-
		◎2.20m <sup>3</sup> (2.88yd <sup>3</sup> )	1.80m <sup>3</sup> (2.35yd <sup>3</sup> )	5	1810mm(71.3")	-
		◎2.43m <sup>3</sup> (3.18yd <sup>3</sup> )	2.10m <sup>3</sup> (2.75yd <sup>3</sup> )	5	1860mm(73.2")	-
		◎3.20m <sup>3</sup> (4.19yd <sup>3</sup> )	2.80m <sup>3</sup> (3.66yd <sup>3</sup> )	7	2080mm(81.9")	-

◆ : Heavy duty bucket

◎ : Rock bucket(Esco type)

## 9. RECOMMENDED OILS

Use only oils listed below or equivalent.

Do not mix different brand oil.

Service point	Kind of fluid	Capacity l (U.S. gal)	Ambient temperature °C (°F)					
			-20 (-4)	-10 (14)	0 (32)	10 (50)	20 (68)	30 (86)
Engine oil pan	Engine oil	38(10)	SAE 30					
			SAE 10W					
			SAE 10W-30					
						SAE 15W-40		
Swing drive	Gear oil	5.0×2 (1.3×2)	SAE 85W-140					
Final drive		5.0×2 (1.3×2)						
Hydraulic tank	Hydraulic oil	Tank; 250(66) System; 380(100)	ISO VG 32					
						ISO VG 46		
						ISO VG 68		
Fuel tank	Diesel fuel	610(161)	ASTM D975 NO.1					
						ASTM D975 NO.2		
Fitting (Grease nipple)	Grease	As required	NLGI NO.1					
						NLGI NO.2		
Radiator (Reservoir tank)	Mixture of antifreeze and water 50 : 50	50(13.2)	Ethylene glycol base permanent type					

**SAE** : Society of Automotive Engineers

**API** : American Petroleum Institute

**ISO** : International Organization for Standardization

**NLGI** : National Lubricating Grease Institute

**ASTM** : American Society of Testing and Material