

3. STARTING AND STOP THE ENGINE

1) CHECK INDICATOR LIGHTS

- (1) Check if all the operating levers are in the neutral position.
- (2) Turn the starting switch to the ON position.
Buzzer sounding for 4 seconds with HYUNDAI logo on cluster.
 - ※ If the ESL mode is set to the enable, enter the password to start engine.
 - ※ If the password has failed 5 times, please wait 30 minutes before re-attempting to enter the password.
 - ※ Refer to page 3-17 for ESL mode.
- (3) After initialization of cluster, the operating screen is displayed on LCD (1).
Also, self-diagnostic function is carried out.

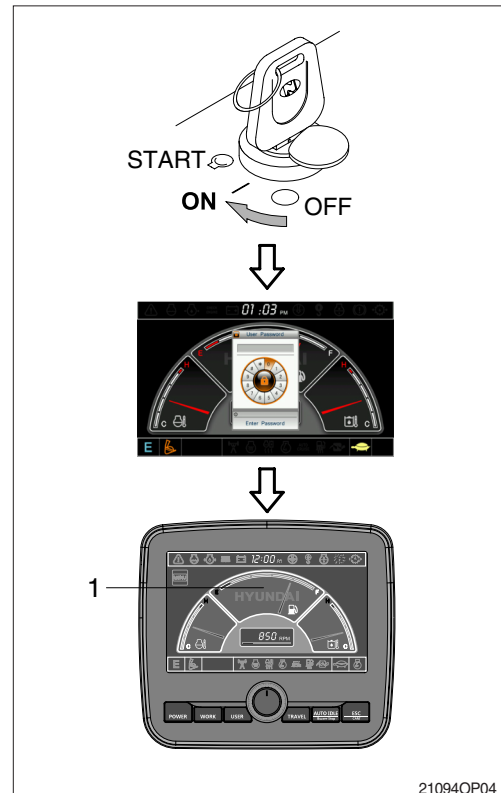

2) STARTING ENGINE IN NORMAL TEMPERATURE

- ※ Sound the horn to warn the surroundings after checking if personnel or obstacles are in the area.
- (1) Turn the accel dial switch to low idle position.
 - (2) Turn the starting switch to START position to start the engine.
 - ※ Do not hold the starting switch in the START position for longer than 20 seconds.
The start system may be seriously damaged.
 - ※ If the engine does not start, allow the stator to cool for about 2 minutes before re-attempting to start the engine again.
 - (3) Release the starting switch instantly after the engine starts to avoid possible damage to the starting motor.

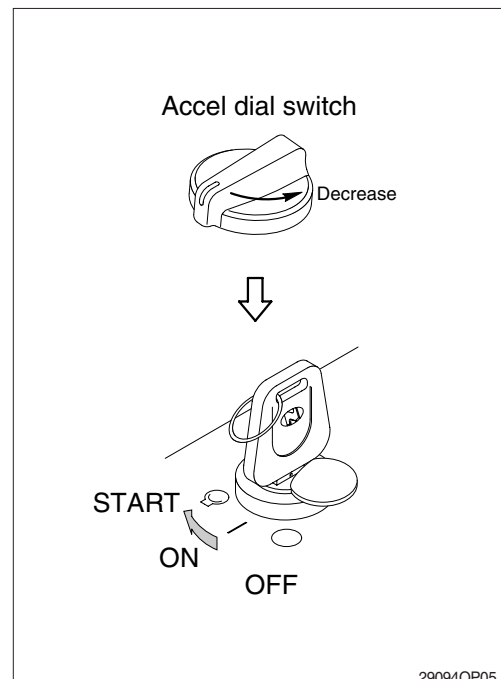

3) STARTING ENGINE IN COLD WEATHER

- ※ Sound horn to warn surroundings after checking if there are obstacles in the area.
 - ※ Replace the engine oil and fuel referring to recommended oils at page 2-34.
 - ※ Fill the anti-freeze solution to the coolant as required.
 - ※ If you turn ON the starting switch, the fuel warmer is automatically operated to heat the fuel by sensing the coolant temperature.
- (1) Check if all the levers are in the neutral position.
 - (2) Turn the accel dial switch to low idle position.
 - (3) Turn the starting switch to the ON position, and wait 1~2 minutes. More time may take according to ambient temperature.
 - (4) Wait for five minutes to warm up the engine after the preheating pilot lamp off, and then turn the starting switch to the START position to start the engine.
 - ※ If the engine does not start, allow the starter to cool for about 2 minutes before attempting to start the engine again.
 - (5) Release the starting switch immediately after starting engine.
 - (6) If the temperature of the coolant is lower than 30°C the warming up automatically starts.
 - ※ Do not operate the working devices, or convert the operation mode into other mode during the warming up.

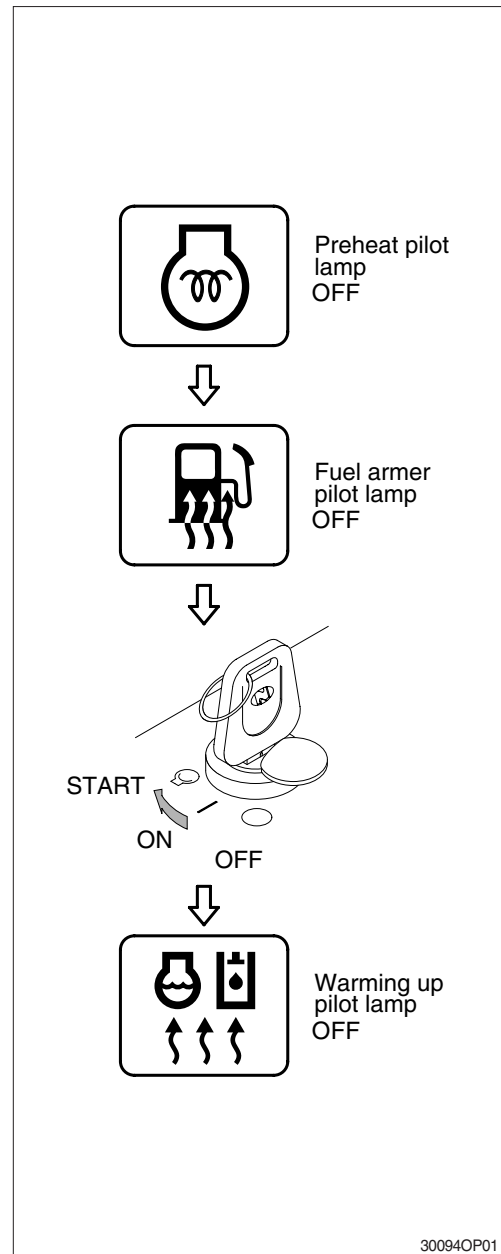

4) INSPECTION AFTER ENGINE START

Inspect and confirm the following after engine starts.

- (1) Is the level gauge of hydraulic oil tank in the normal level?
 - (2) Are there leakages of oil or water?
 - (3) Are all the warning lamps turned OFF (1-9)?
 - (4) Are the indicator of water temperature gauge (10) and hydraulic temperature gauge (11) in the operating range?
 - (5) Are the engine sound and the color of exhaust gas normal?
 - (6) Are the sound and vibration normal?
- ※ **Do not increase engine speed quickly after starting, it can damage engine or turbocharger.**
 - ※ **If there are problems in the cluster, stop the engine immediately and correct problems as required.**

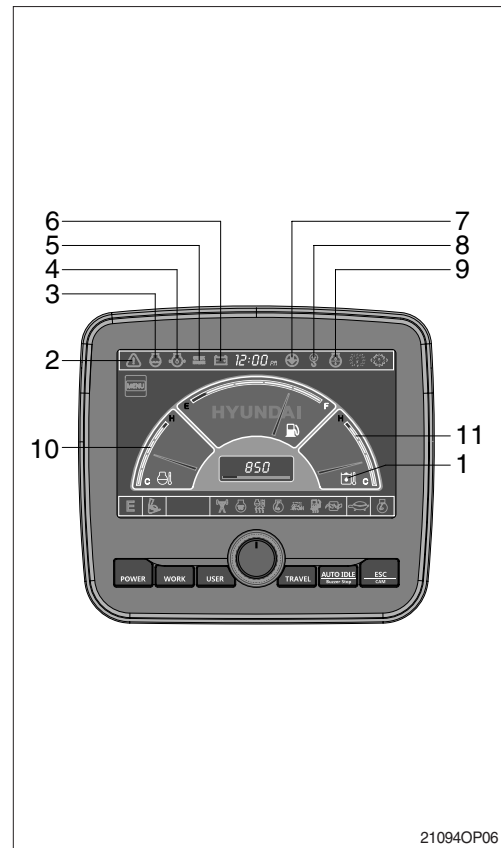

5) WARMING-UP OPERATION

- ※ **The most suitable temperature for the hydraulic oil is about 50°C (122°F).**
It can cause serious trouble in the hydraulic system by sudden operation when the hydraulic oil temperature is below 25°C (77°F).
Then temperature must be raised to at least 25°C (77°F) before starting work.

- (1) Run the engine at low idle speed for 5 minutes.
- (2) Speed up the engine by accel dial and run the engine at mid-range speed.
- (3) Operate bucket lever for 5 minutes.
 - ※ **Do not operate anything except bucket lever.**
- (4) Run the engine at the high speed and operate the bucket lever and arm lever for 5-10 minutes.
 - ※ **Operate only the bucket lever and arm lever.**
- (5) This warming-up operation will be completed by operation of all cylinders several times, and operation of swing and traveling.

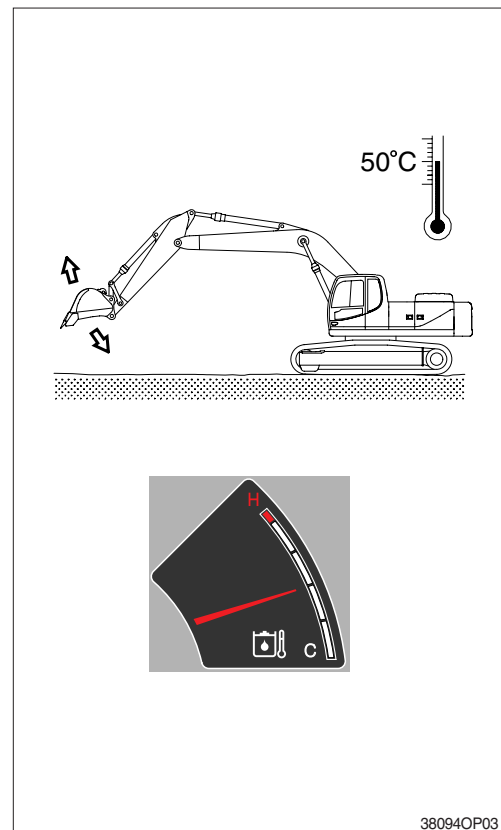

6) TO STOP THE ENGINE

- ※ If the engine is abruptly stopped before it has cooled down, engine life may be greatly shortened. Consequently, do not abruptly stop the engine apart from an emergency.
 - ※ In particular, if the engine has overheated, do not abruptly stop it but run it at medium speed to allow it to cool gradually, then stop it.
- (1) Down the bucket on the ground then put all the levers in the neutral position.
 - (2) Run the engine at low idle speed for about 5 minutes.
 - (3) Return the key of starting switch to the OFF position.
 - (4) Remove the key to prevent other people using the machine and LOCK safety lever.
 - (5) Lock the cab door.

