

SPECIFICATIONS

1. MAJOR COMPONENT

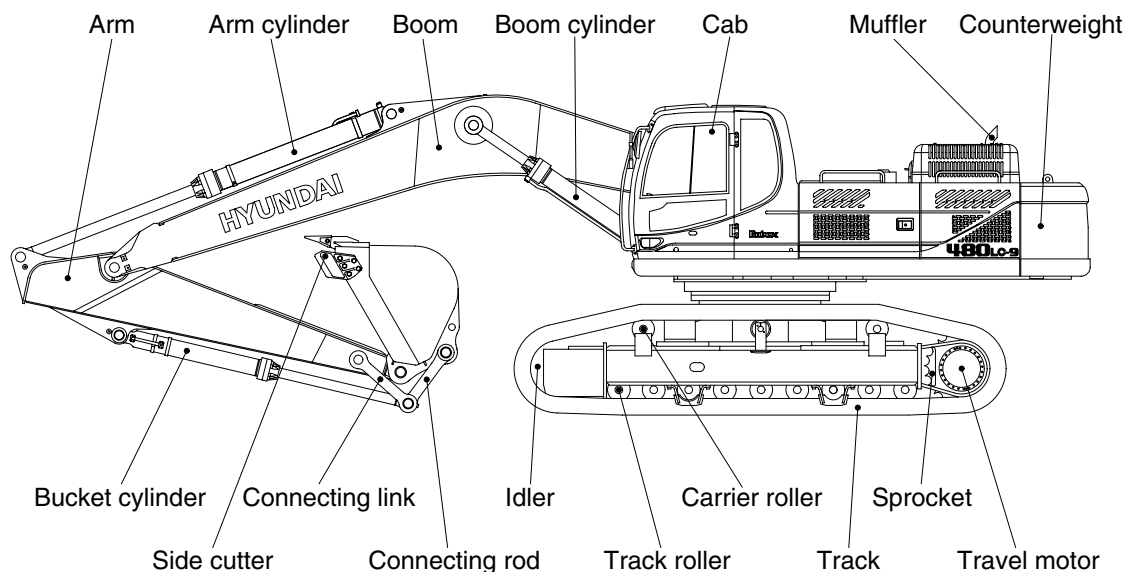
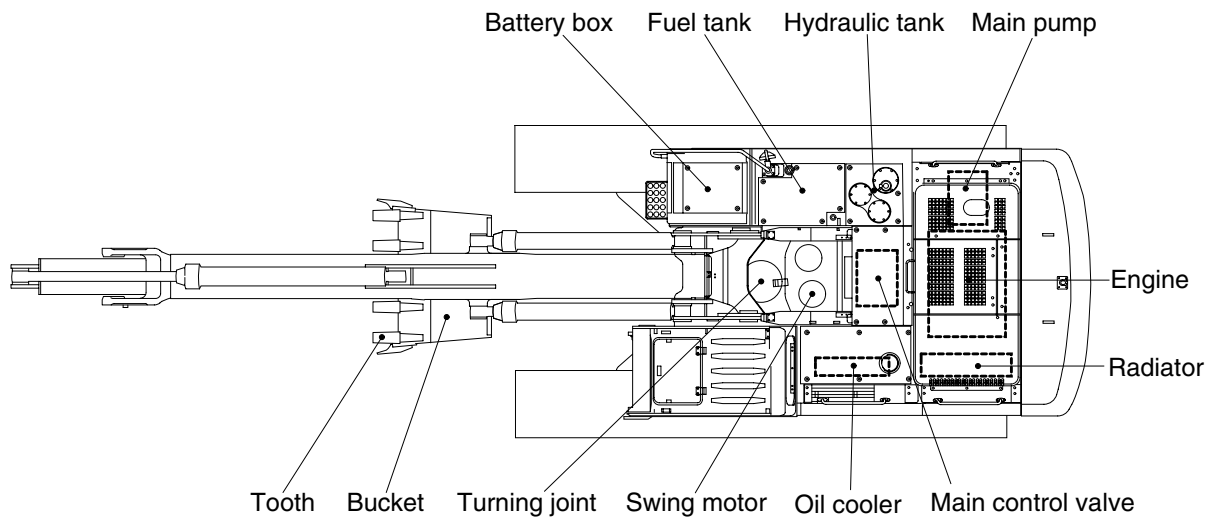

48092SP01