

SPECIFICATIONS

1. MAJOR COMPONENT

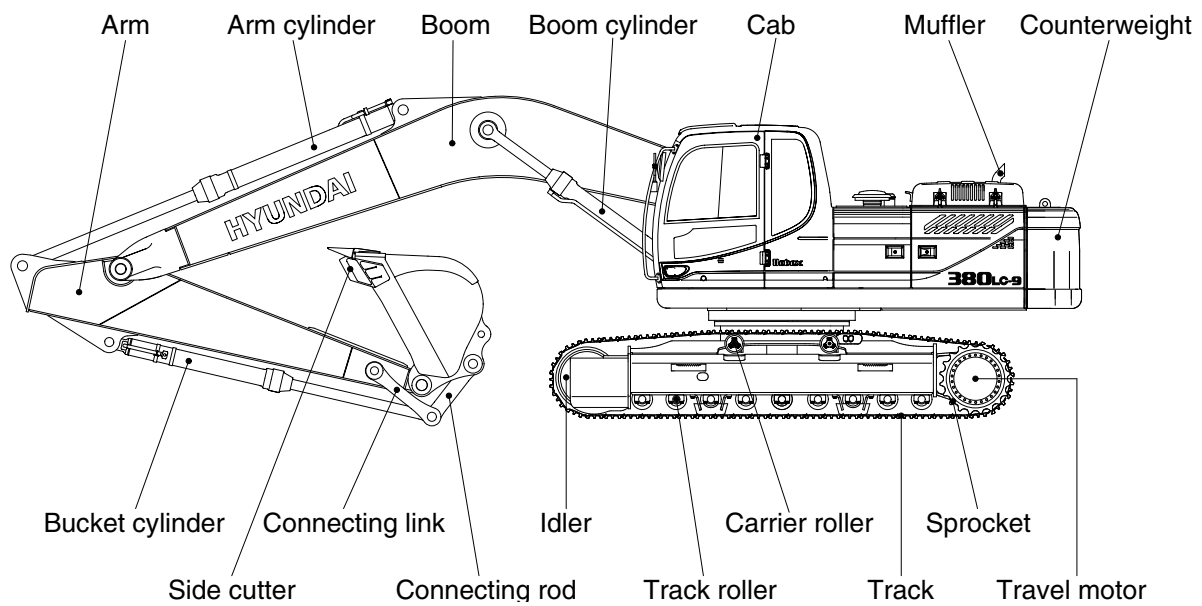
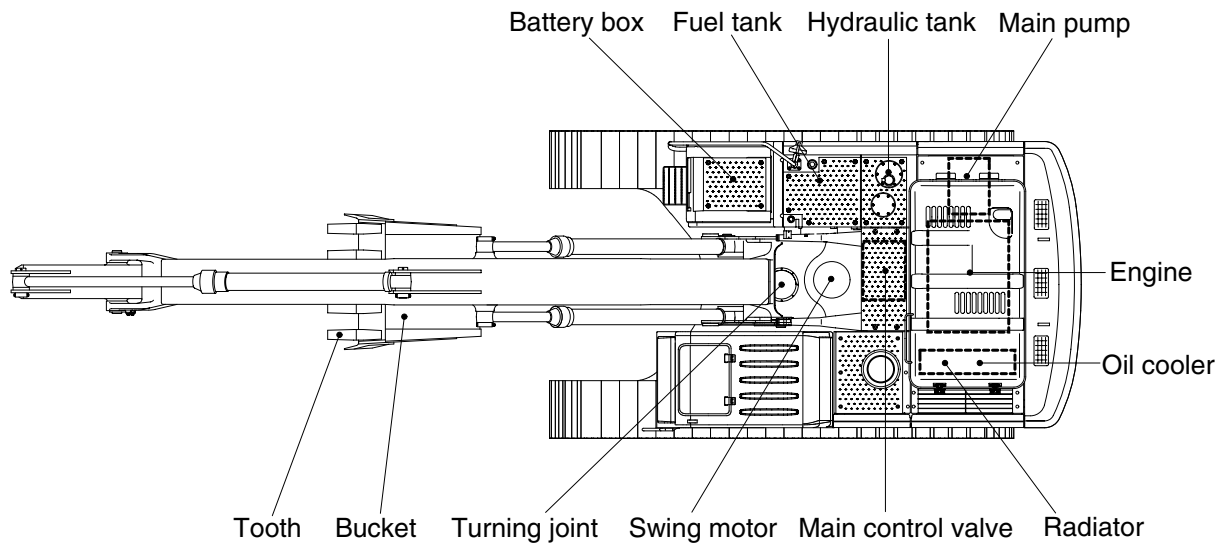

38092SP01