

Check daily according to the operation manual.
Repair the damaged parts and tighten the loosened bolts.

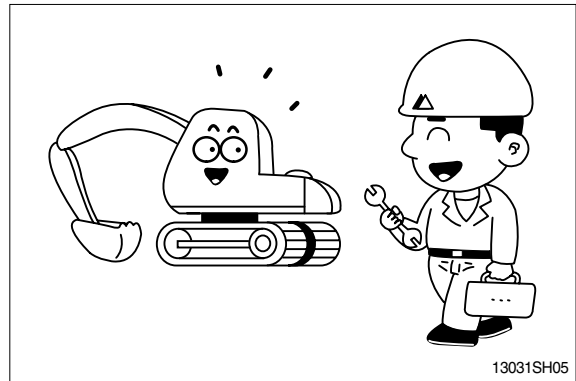

Check for leakage of engine oil, hydraulic oil,
fuel and coolant.
Keep machine clean, clean machine regularly.

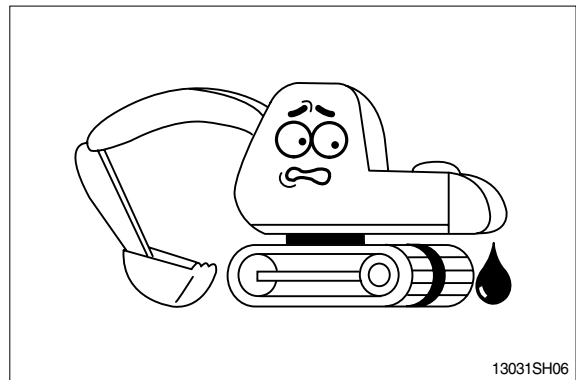

Do not operate the machine if it requires repairs.
Operate after complete repair.

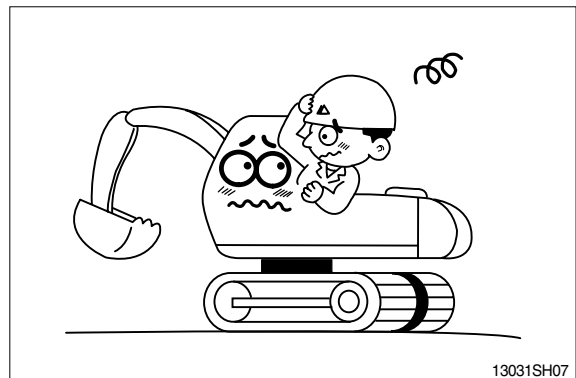

Be prepared if a fire starts.
Keep a fire extinguisher handy and emergency
numbers for a fire department near your
telephone.

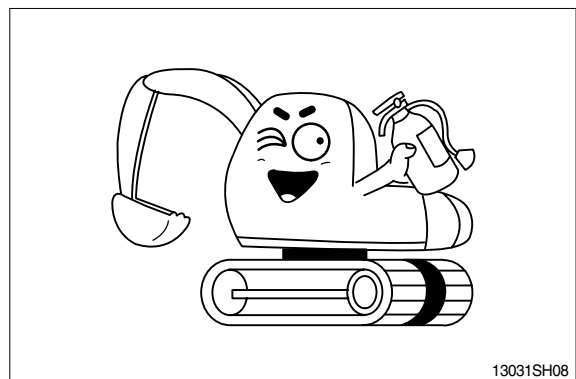

UNAUTHORIZED MODIFICATION

Any modification made without authorization from Hyundai can create hazards.

Before making a modification, consult your Hyundai distributor. Hyundai will not be responsible for any injury or damage caused by any unauthorized modification.



PREPARE FOR EMERGENCY

Only in case of emergency, use the installed hammer for breaking the windshield of the cab, and then exit carefully.

Have a fire extinguisher and first aid kit ready for emergencies such as fires or accidents.

Learn how to use the fire extinguisher.

Be sure you know the phone numbers of persons you should contact in case of an emergency.

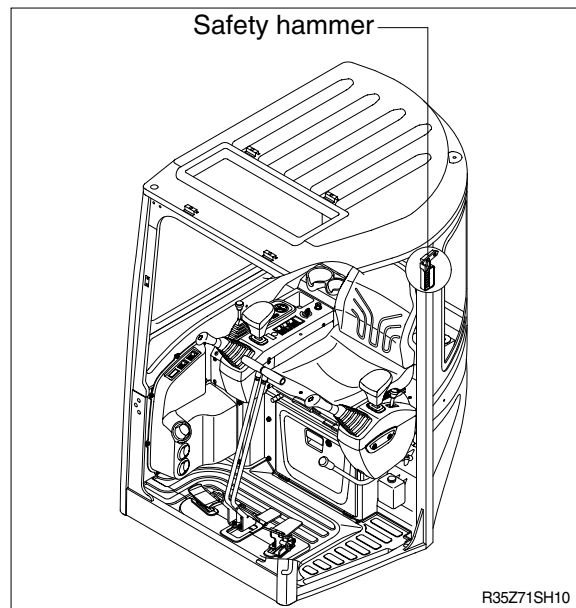

ROTATING BEACON

When you operate a machine on a road or beside a road, a rotating beacon is required to avoid any traffic accident.

Please contact your Hyundai distributor to install it.

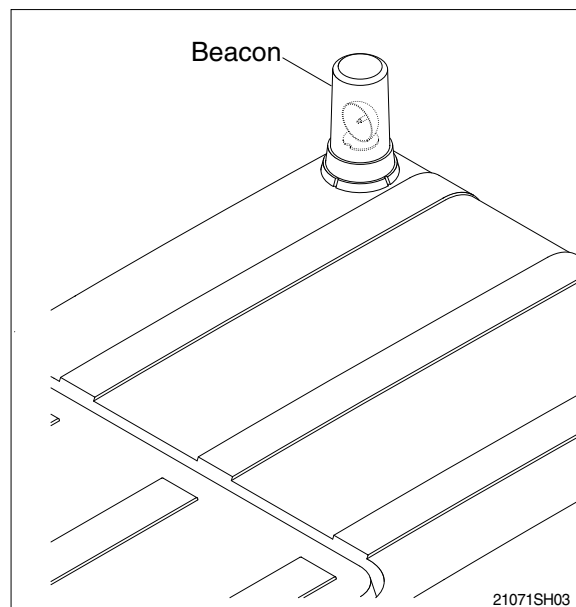

PRECAUTIONS FOR ATTACHMENTS

When installing and using an optional attachment, read the instruction manual for the attachment and the information related to attachments in this manual.

Do not use attachments that are not authorized by Hyundai or your Hyundai distributor. Use of unauthorized attachments could create a safety problem and adversely affect the proper operation and useful life of the machine.

Any injuries, accidents, product failures resulting from the use of unauthorized attachments are not the responsibility of Hyundai.

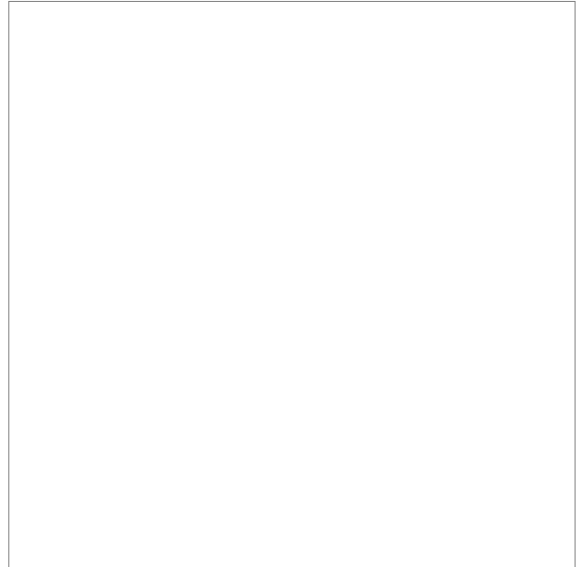

SAFETY RULES

Only trained and authorized personnel can operate and maintain the machine.

Follow all safety rules, precautions and instructions when operating or performing maintenance on the machine.

When working with another operator or a person on worksite traffic duty, be sure all personnel understand all hand signals that are to be used.

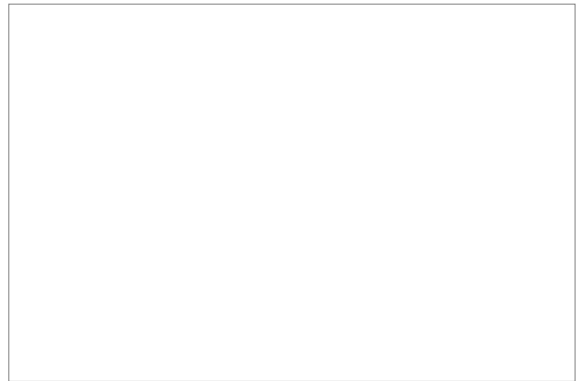

SAFETY FEATURES

Be sure all guards and covers are in their proper position. Have guards and covers repaired if damaged.

Use safety features such as safety lock and seat belts properly.

Never remove any safety features. **Always** keep them in good operating condition.

Improper use of safety features could result in serious bodily injury or death.

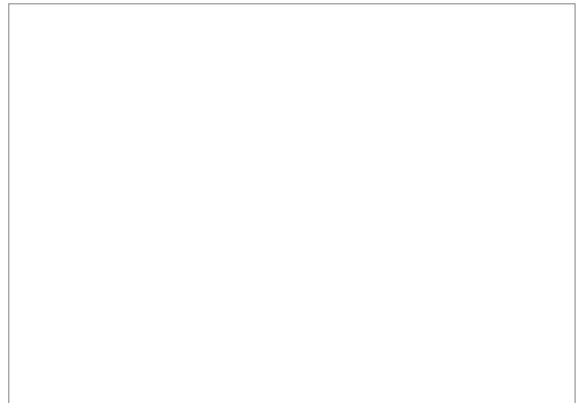

MACHINE CONTROL PATTERN

Check machine control pattern for conformance to pattern on label in cab.

If not, change label to match pattern before operating machine.

Failure to do so could result in injury.

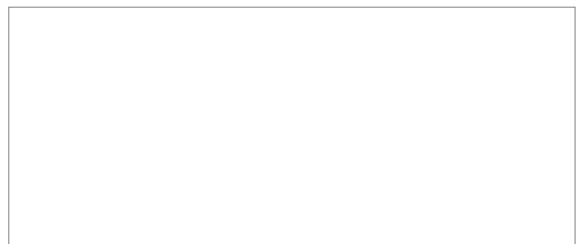

CALIFORNIA PROPOSITION 65

Diesel engine exhaust and some of its constituents are known to the State of California to cause cancer, birth defects and other reproductive harm.

This product contains or emits chemicals known to the State of California to cause cancer or birth defects or other reproductive harm.

Battery posts, terminals and related accessories contain lead and lead compounds.

WASH HANDS AFTER HANDLING

**BATTERIES
AND RELATED PARTS
CONTAIN LEAD**



**WASH HANDS
AFTER HANDLING !**

WARNING : Battery posts, terminals and related accessories contain lead and lead compounds, chemicals known to the State of California to cause cancer and reproductive harm.

13031SH55

Do not load the machine with the lifting eyes on the counterweight.

▲ The wrong loading method can result in serious bodily injury or death.

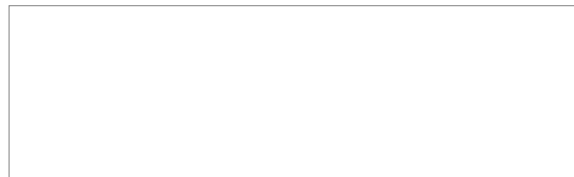

2. DURING OPERATING THE MACHINE

Use the handle and footstep when getting on or off the machine.

Do not jump on or off the machine.

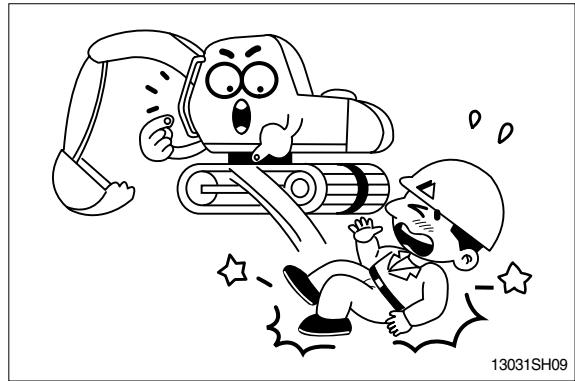

Sound the horn to warn nearby personnel before operating the machine.

Remove all the obstacles like frost on the window before operating the machine for the good visibility.

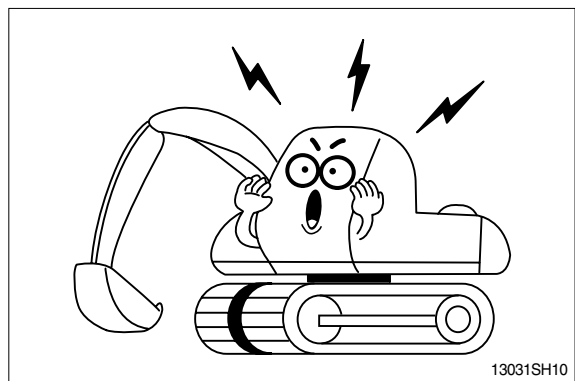

Operate carefully to make sure all personnel or obstacles are clear within the working range of the machine.

Place safety guards if necessary.

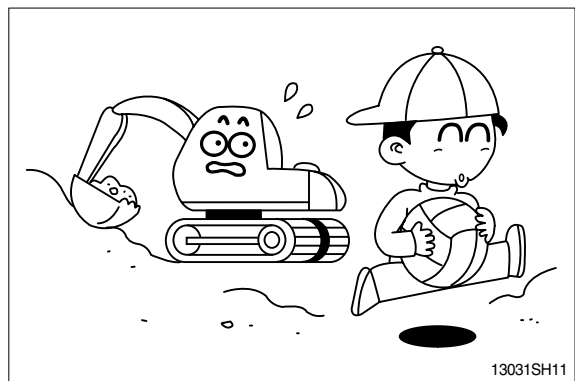

When using the work equipment, pay attention to job site.

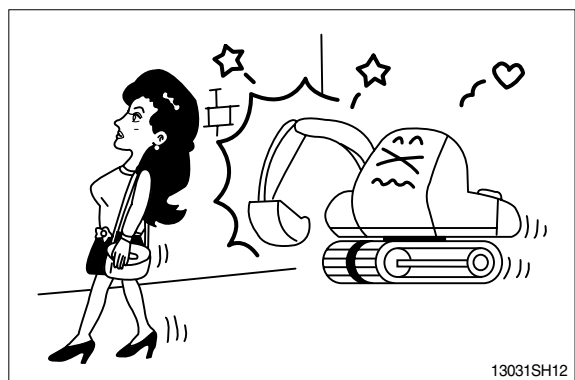

Provide proper ventilation when operating engine in a closed area to avoid the danger of exhaust gases.

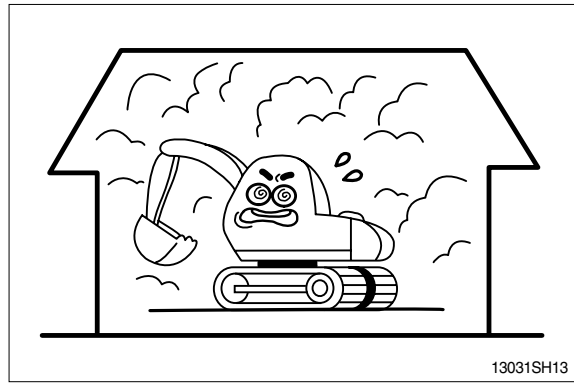

Check the locations of underground gas pipes or water line and secure the safety before operation.

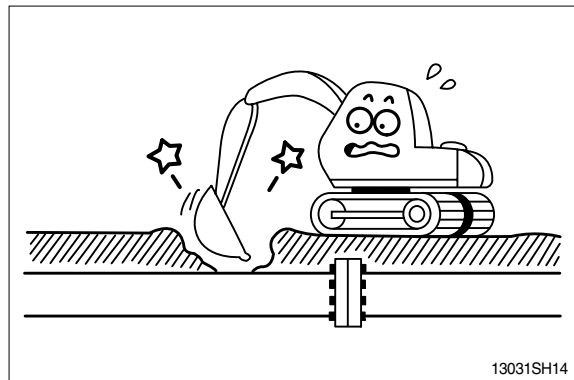

The operating near the electrical lines is very dangerous.

Operate within safe working range permitted as below.

Supply voltage	Min safe separation
6.6kV	3m(10ft)
33.0kV	4m(13ft)
66.0kV	5m(16ft)
154.0kV	8m(26ft)
275.0kV	10m(33ft)

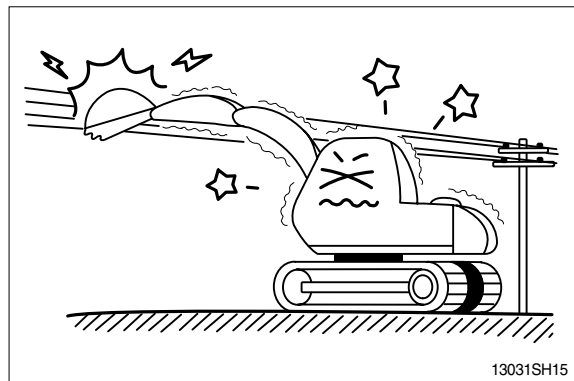

If the machine touches the electric power lines, keep sitting on the operator's seat and make sure the personnel on the ground not to touch the machine until turning off the electric current. Jump off the machine without contacting the machine when you need to get off.

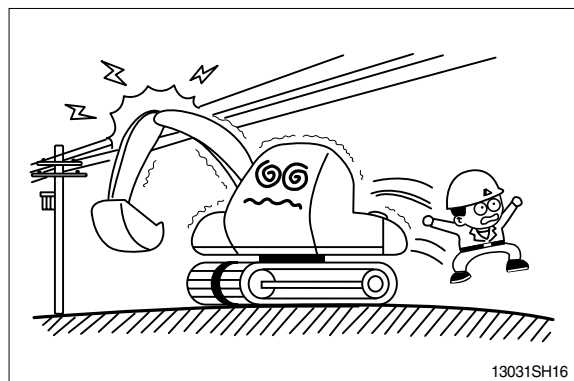

Watch out for obstacles.

Be particularly careful to check the machine clearance during the swing.

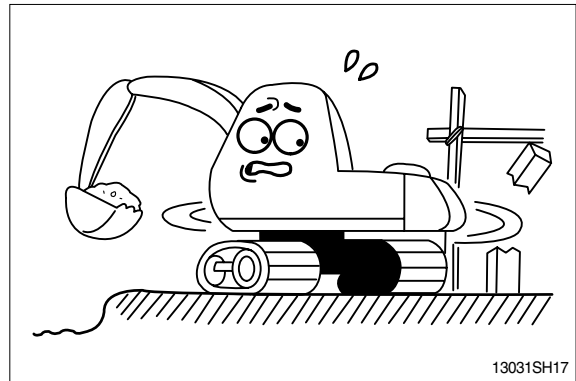

When using the machine as breaker or working in a place where stones may fall down, cab roof guard and head guard should be provided for proper protection.

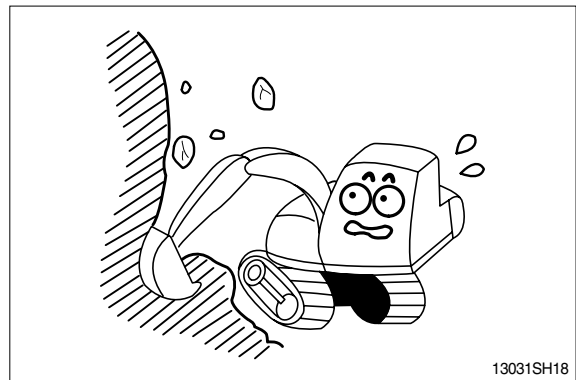

Avoid operating on a cliff or soft ground as there is danger of rolling over.

Make sure to get off easily as keeping the track at a right angle and putting the travel motor into the backward position when working on a cliff or soft ground inevitably.

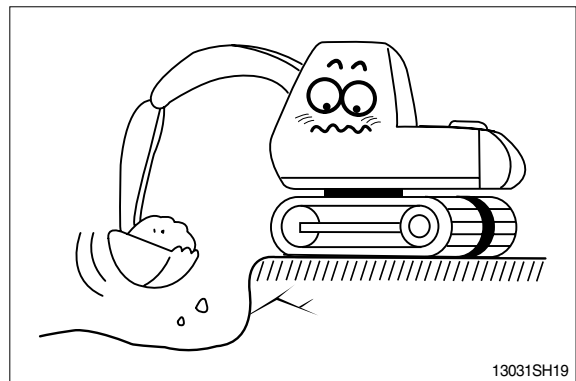

Operate for the lifting work considering the capacity of machine, weight and width of the load.

Be careful not to lift exceeding the machine capacity as it can be the cause of machine damage and safety accident.

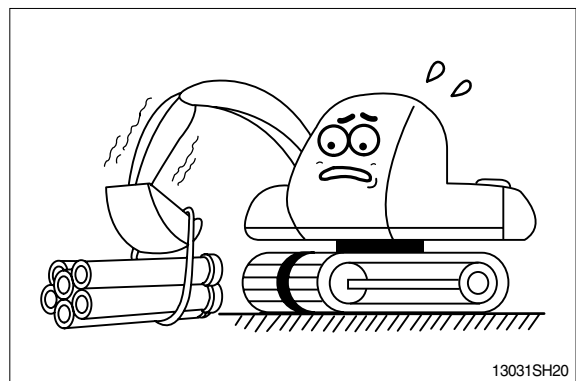

The operation on a slope is dangerous.
Avoid operating the machine on a slope of over 10 degree.

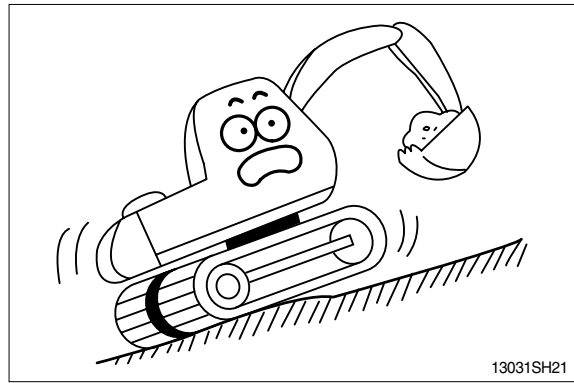

Operate the machine after making ground flat when operation is required on a slope.

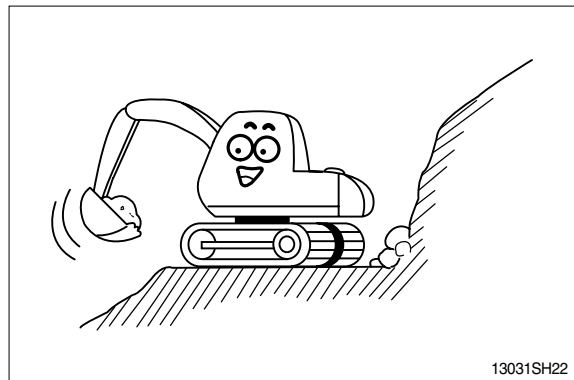

The swing on the slope can be danger of rolling over.
Do not operate to swing the machine with the bucket loaded on a slope since the machine may lose its balance under such an instance.

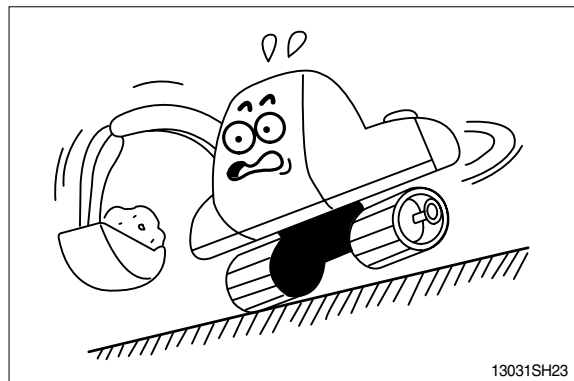

Avoid parking and stopping on a slope.
Lower the bucket to the ground and block the track when parking.

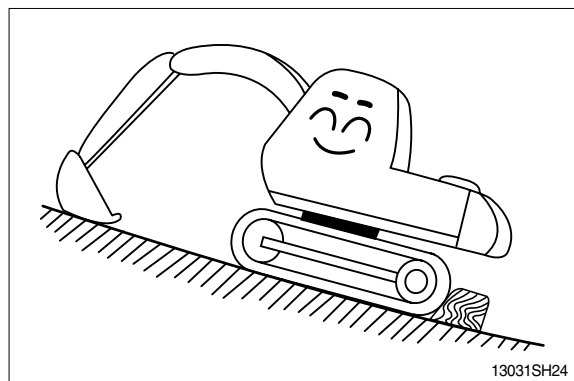

Avoid traveling in a cross direction on a slope as it can cause the danger of rolling over and sliding.

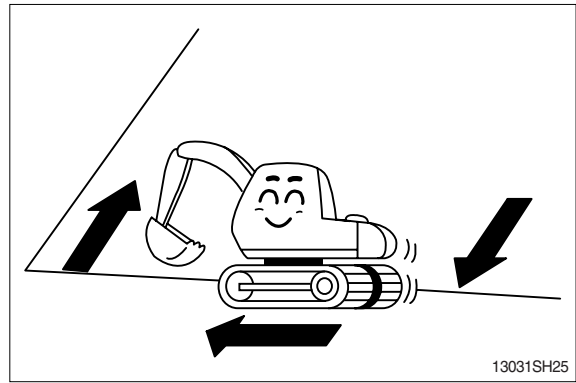

Traveling on a slope is dangerous. Be sure to operate slowly when traveling down a slope and maintain the bucket at a height of 20~30cm(1ft) above the ground so that it can be used as brake in an emergency.

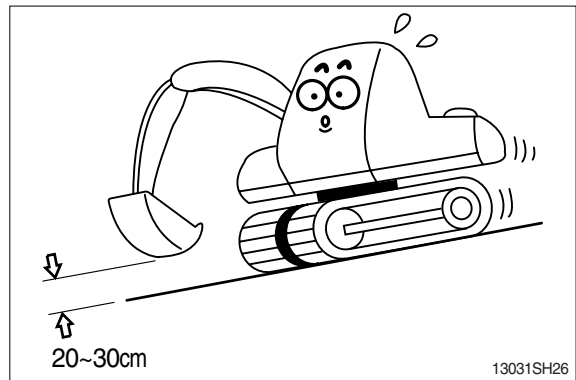

Steering of the machine while traveling on a slope is dangerous. When an inevitable turning of direction is required, turn on the flat and solid ground.

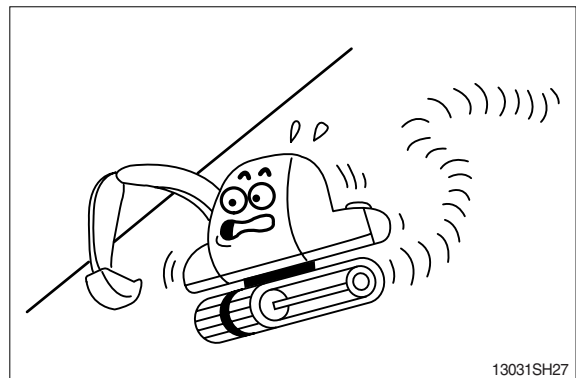

The engine angularity limits are 35 degree. Do not operate by more than the engine limits in any case.

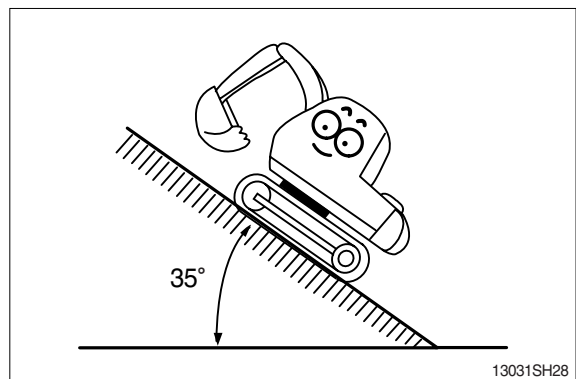

Before traveling the machine, sound the horn to warn nearby personnel.
Operate forward and backward correctly with confirming the location of the travel motor.

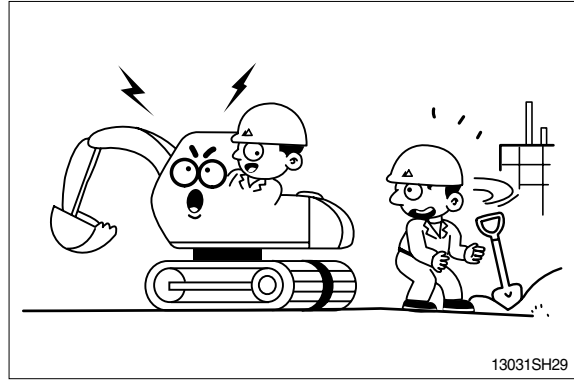

Slow down when traveling through obstacles or uneven ground.

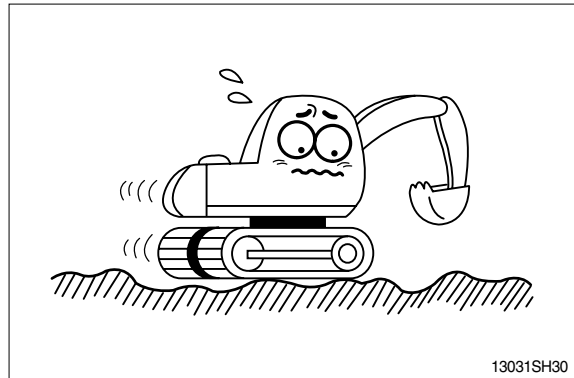

When working on soft ground, place mats or wood boards on the ground to prevent the machine sinking.

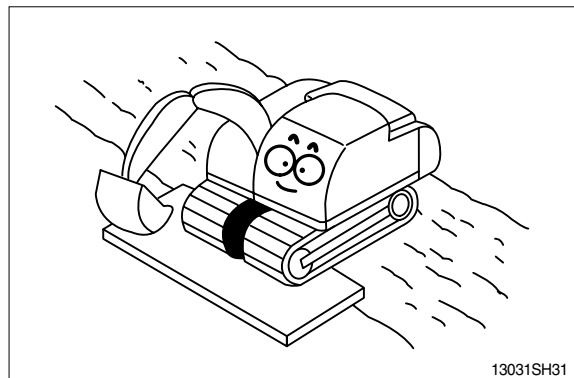

When operating in water or when crossing shallow, check the bed soil condition and depth and flow speed of water, then proceed taking care that water is not above carrier roller.

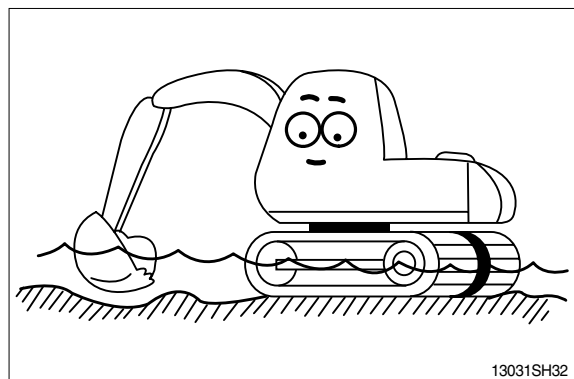

MOUNTING AND DISMOUNTING

Never jump on or off the machine. **Never** get on or off a moving machine.

When mounting or dismounting, always face the machine and use the handrails, machine and track shoes.

Do not hold any control levers when getting on or off the machine.

Ensure safety by always maintaining at least three-point contact of hands and feet with the handrails, and track shoes.

Always remove any oil or mud from the handrails and track shoes. If they are damaged, repair them and tighten any loose bolts.

If grasping the door handrail when mounting or dismounting or moving on the track, open and lock the door securely in the open position. Otherwise, the door may move suddenly, causing you to lose balance and fall.

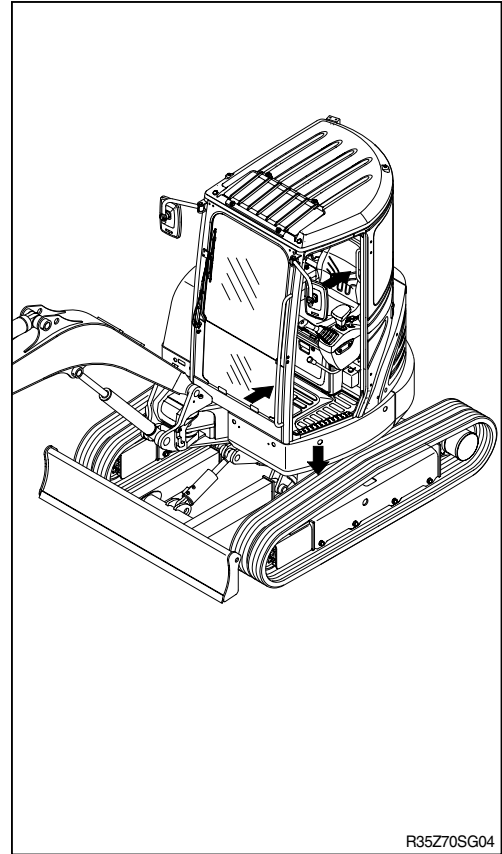

3. DURING MAINTENANCE

Stop the engine immediately when the trouble of the machine is found.

Inspect immediately the cause of trouble such as vibration, overheating and trouble in the cluster then repair.

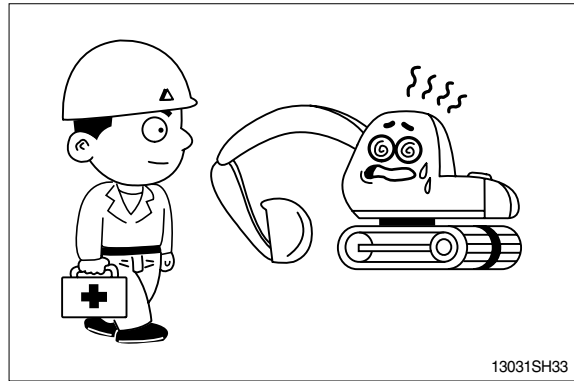

Park on a flat place and stop the engine for inspecting and repairing. Properly TAG machine is not operational. (Remove start key)
Extreme care shall be taken during maintenance work. Parts may require additional safe guard.

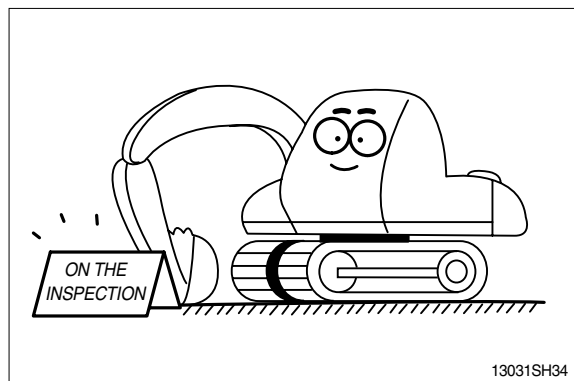

Do not remove the radiator cap from hot engine.
Open the cap after the engine cools, below 50°C(112°F) to prevent personal injury from heated coolant spray or steam.

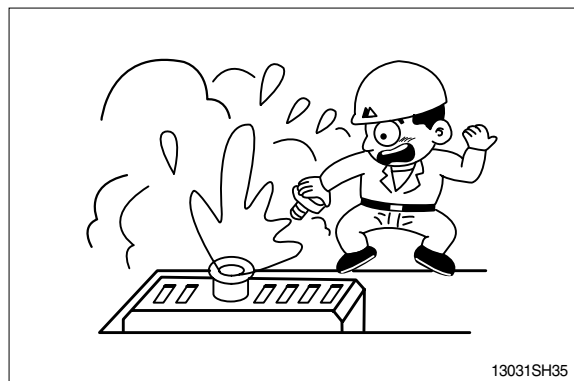

Do not work below the machine.
Be sure to work with proper safety supports.
Do not depend on the hydraulic cylinders to hold up the equipment and attachment.

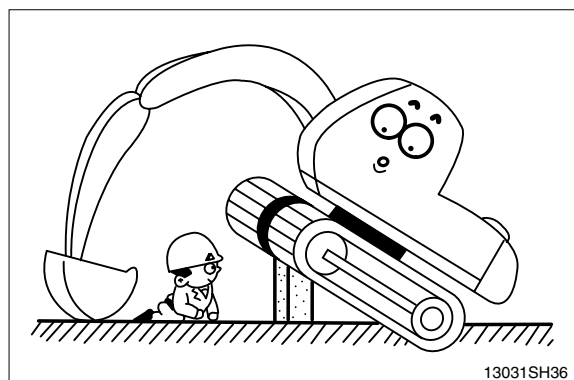

There is the danger of fire in fuel and oil.
Store in cool and dry area, away from any open flames.

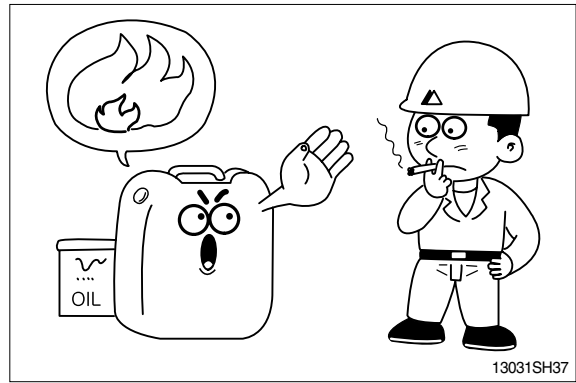

Do not touch exhaust pipe, or may cause severe burn.

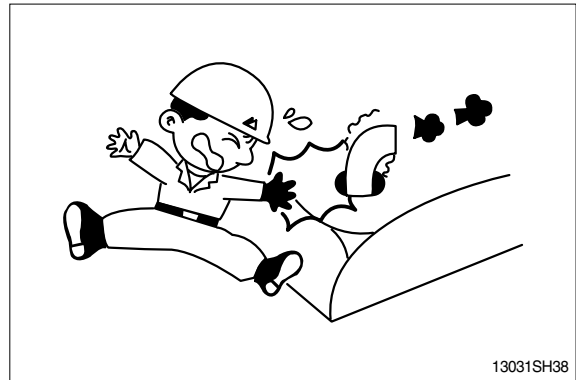

Do not open the engine hood and covers while the engine is running.



Be careful of not hitting the edges when you service engine.

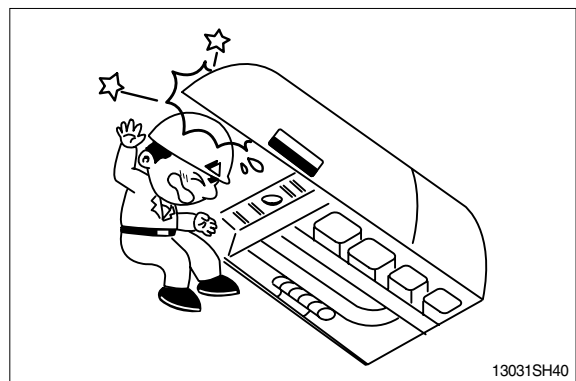

The antislip protection should be replaced if they have become worn or have been printed over. Be sure to free of oil, water and grease etc.

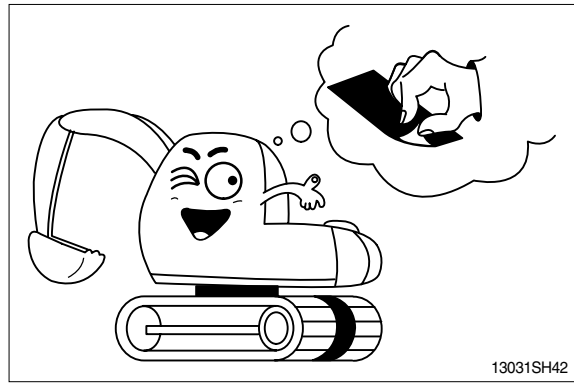

Be careful of not touching slip, fall down etc., when you work at the upper frame to service engine and/or other component.

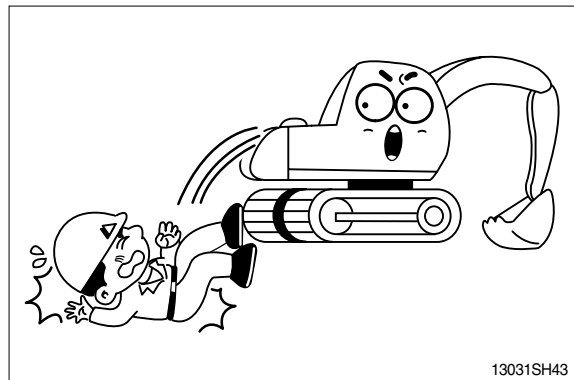

HIGH PRESSURE GAS

Contain high pressure gas. To avoid explosion and personal injury, do not expose to fire, do not weld, do not drill. Relieve pressure before discharging.

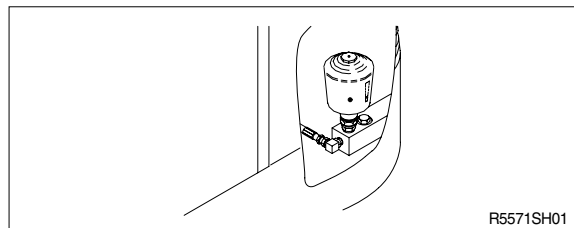

LIFT EYES CAN FAIL

Lift eyes or tank can fail when lifting tank containing fluids resulting in possible personal injury. Drain tank of all fluids before lifting.



4. PARKING

When leaving the machine after parking, lower the bucket to the ground completely and put the safety lever at parking position then remove the key.

Lock the cab door.

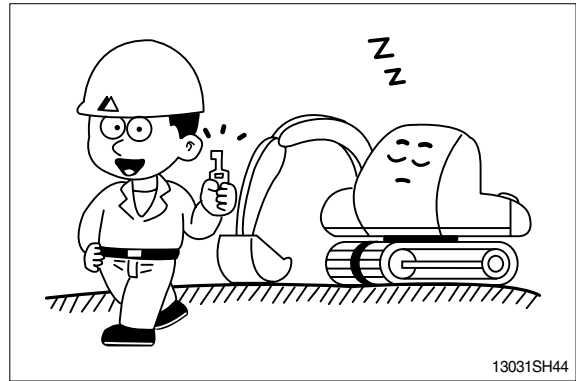

Park the machine in the flat and safe place.

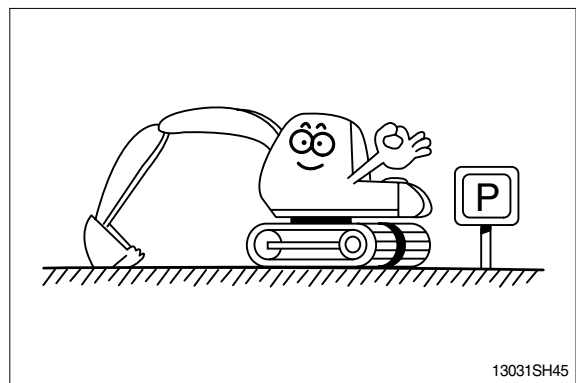

Hope you can work easily and safely observing safety rules.

For safe operation, observe all safety rules.

