

7. ELECTRICAL SYSTEM

1) WIRING, GAUGES

Check regularly and repair loose or malfunctioning gauges when found.

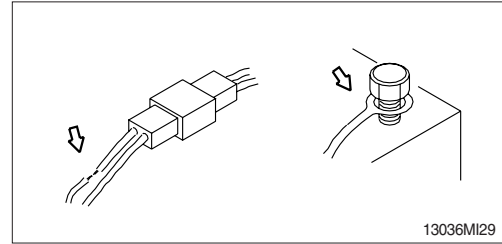

2) BATTERY

(1) Clean

① Wash the terminal with hot water if it is contaminated, and apply grease to the terminals after washing.

⚠ **Battery gas can explode. Keep sparks and flames away from batteries.**

⚠ **Always wear protective glasses when working with batteries.**

⚠ **Do not stain clothes or skin with electrolyte as it is acid.**

Be careful not to get the electrolyte in eyes.

Wash with clean water and go to the doctor if it enters the eyes.

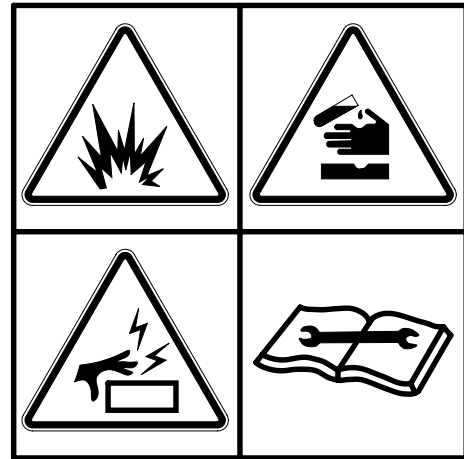

(2) Recycle

Never discard a battery.

Always return used batteries to one of the following locations.

- A battery supplier
- An authorized battery collection facility
- Recycling facility

(3) Method of removing the battery cable

Remove the cable from the ground connection first (⊖ terminal side) and reconnect it last when reassembling.

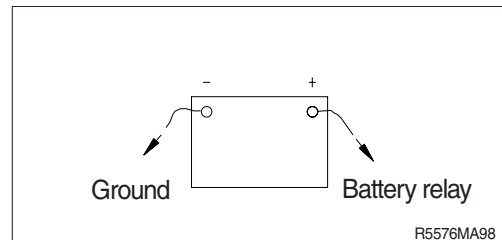

3) STARTING THE ENGINE WITH A BOOSTER CABLE

Keep following order when you are going to start engine using booster cable.

(1) Connection of booster cable

※ **Use the same capacity of battery for starting.**

- ① Make sure that the starting switches of the normal machine and trouble machine are both at the OFF position.
- ② Connect the red terminal of booster cable to the battery (+) terminal between exhausted and new battery.
- ③ Connect the black terminal of the booster cable between new battery (-) terminal and chassis of trouble machine.

※ **Keep firmly all connection, the spark will be caused when connecting finally.**

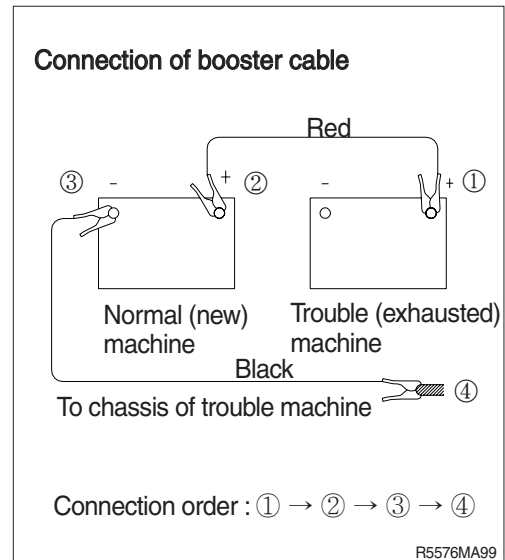

(2) Starting the engine

- ① Starting the engine of the normal machine and keep it to run at high idle.
- ② Start engine of the trouble machine with starting switch.
- ③ If you can not start it by one time, restart the engine after 2 minutes.

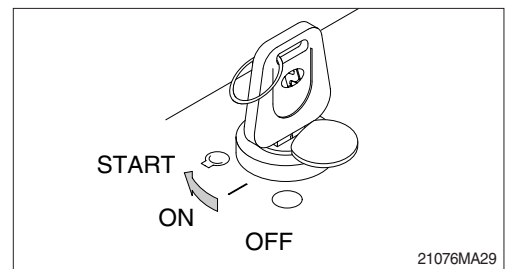

(3) Taking off the booster cable

- ① Take off the booster cable (black).
- ② Take off the booster cable (red) connected to the (+) terminal.
- ③ Run engine with high idle until charging the exhausted battery by alternator, fully.

▲ **Explosive gas is generated while using the battery or charging it. Keep away flame and be careful not to cause the spark.**

※ **Charge the battery in the well ventilated place.**

※ **Place the machine on the earth or concrete. Avoid charging the machine on the steel plate.**

※ **Do not connect (+) terminal and (-) terminal when connecting booster cable because it will be shorted.**

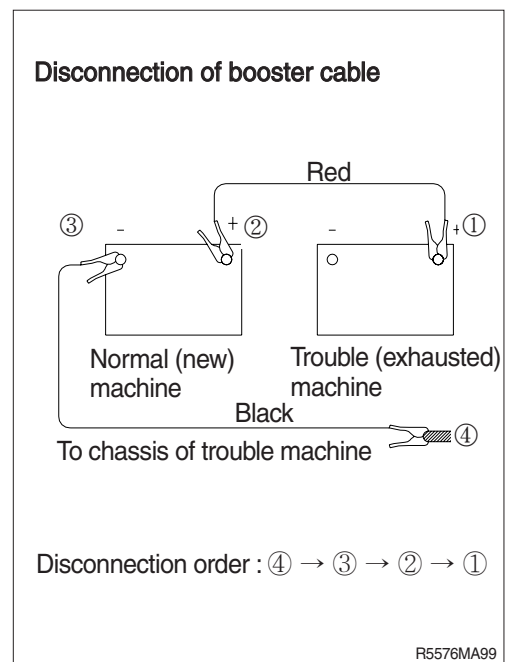

(4) Welding repair

Before start to welding, follow the below procedure.

- ① Shut off the engine and remove the starting switch.
- ② Disconnect ground cable from battery by master switch.
- ③ Before carrying out any electric welding on the machine, the battery cables should be disconnected.
- ④ Connect the earth (ground) lead of the welding equipment as close to the welding point as possible.

※ Do not weld or flame cut on pipes or tubes that contain flammable fluids. Clean them thoroughly with nonflammable solvent before welding or flame cutting on them.

⚠ Do not attempt to welding work before carry out the above.

If not, it will caused serious damage at electric system.

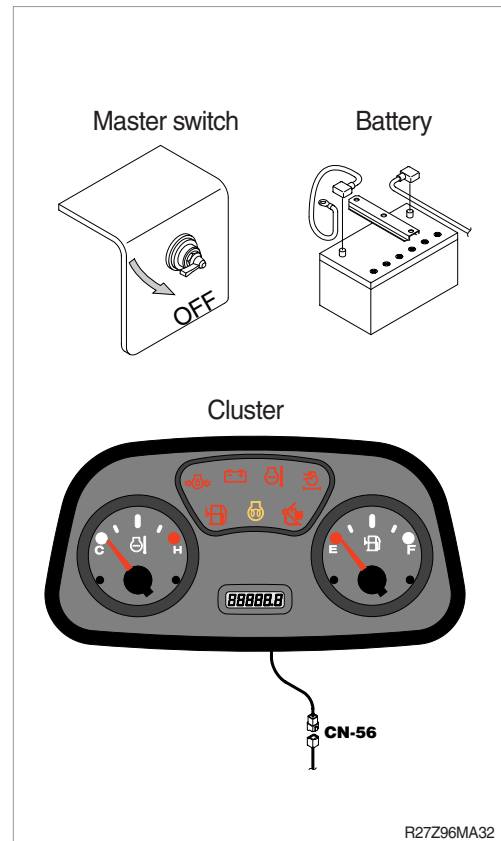

R27Z96MA32