

6. OTHERS

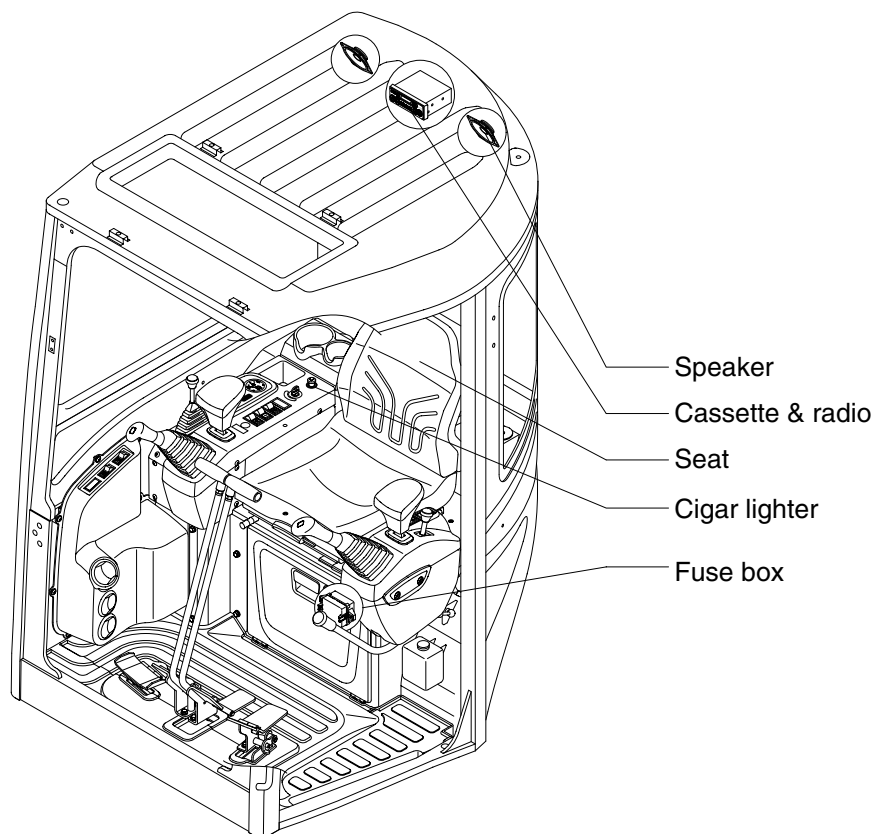

R27Z93CD14

1) CIGAR LIGHTER

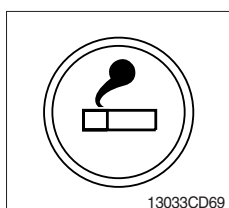

- (1) This can be used when the engine starting switch is ON.
 - (2) The lighter can be used when it springs out in a short while after being pressed down.
- ※ **Service socket**
Use cigar lighter socket when you need emergency power.
Do not use the lighter exceeding 12V, 120W.

2) SEAT

The seat is adjustable to fit the contours of the operator's body. It will reduce operator fatigue due to long work hours and enhance work efficiency.

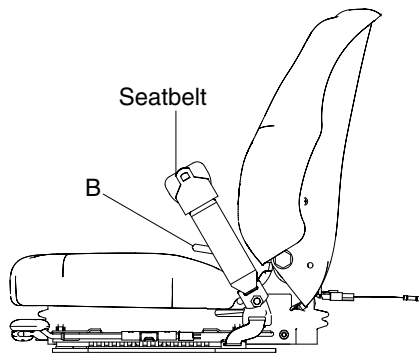
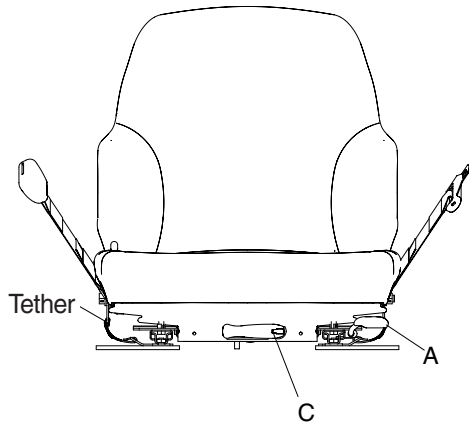

R27Z93CD16

(1) For/aft adjustment (A)

The seat can be positioned over a range 52mm, giving you plenty of room to maneuver in every height and work situation.

(2) Seatback angle adjustment (B)

The seatback adjusts over a range of -5° to $+25^{\circ}$ with 18 locking positions, to give your back full support for every job and make sure you feel best.

(3) Weight adjustment (C)

Just sit down, press the smooth-action lever, click, and you're primed for action, with optimum suspension for all operator weights between 45 and 136 kg (99 and 300 lb). Design comfort with driver appeal-it only takes one simple action to adjust the suspension to the ideal sitting position that's best for you and your back.

(4) Seatbelt system

The seatbelt provides freedom of movement, yet ensure that you're safety restrained in your seat, even if your vehicle should crash or tip over.

▲ Always check the condition of the seat belt and mounting hardware before operating the machine.

▲ Replace the seat belt at least once every three years, regardless of appearance.

3) UPPER WINDSHIELD

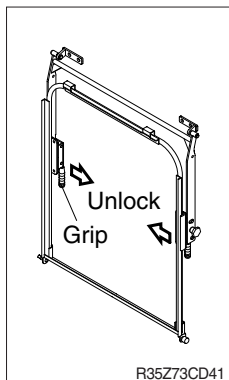

R35Z73CD41

(1) Perform the following procedure in order to open the upper windshield.

① Hold both grips that are located both side of the windshield frame.

② Move grips to inside in order to release the lock latches.

Hold both grips and push the windshield upward.

③ Hold both grips and back into the storage position.

Release both grips carefully until lock latches are into the locking position.

④ Hold both grips and back into the storage position.

⑤ Release both grips carefully until lock latches are into the locking position.

(2) Perform the following procedure in order to close the upper windshield.

Reverse step ① through step ⑤ in order to close the upper windshield.

4) FUSE BOX

20A	WIPER MOTOR 와이퍼모터	SPARE,10A	20A	BEACON CASSETTE 경광등,카세트
20A	HORN, CIGAR 경적음		20A	CABIN LAMP 케빈 전등
20A	SAFETY SOL. TRAVEL SOL. 슬레노이드	SPARE,20A	20A	WORK LAMP 작업등
10A	FUEL FEED PUMP, ALT. 연료공급펌프		20A	HEATER 히터
20A	OPTION 선택장치	SPARE,20A	20A	SPARE
	FUSE PULLER		10A	MONITOR RADIO 모니터/오디오
			20A	B+ 상시전원

R27Z93CD60

(1) The fuses protect the electrical parts and wiring from burning out.

(2) The fuse box cover indicates the capacity of each fuse and circuit it protects.

※ **Replace a fuse with another of the same capacity.**

▲ **Before replacing a fuse, be sure to turn OFF the starting switch.**

5) RADIO AND CASSETTE

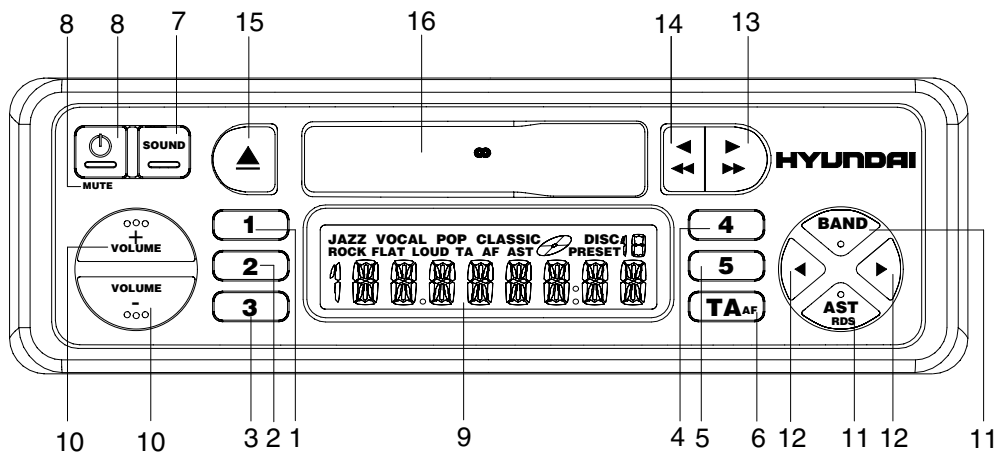

7807A3CD81

■ FRONT PANEL PRESENTATION

- | | | | | | |
|----|-------|---|------|------------------------------------|-------------------------------|
| 1 | | Preset button 1 | 11 | RDS | Long press : RDS on/off |
| 2 | | Preset button 2 | BAND | Short press : To select band | |
| 3 | | Preset button 3 | AST | Short press : Autostore | |
| 4 | | Preset button 4 | 12 | | Tuner mode |
| 5 | | Preset button 5 | | Short press : Auto search up/down | |
| 6 | | Short press : TA on/off | | Long press : Manual search up/down | |
| | | Long press : AF on/off | | Cassette mode : No function | |
| 7 | SOUND | Select sound/audio styles | 13 | | Fast forward |
| 8 | | Short press : power on | 14 | | Fast rewind |
| | | Long press : power off | 15 | | Eject cassette |
| | MUTE | Short press : To mute or cancel mute. | 16 | | Cassette opening |
| 9 | | Display | | | |
| 10 | | Volume knob : Press up/down to adjust the volume ; adjust selected audio mode | | | |

■ AUDIO

(1) Power and mute button

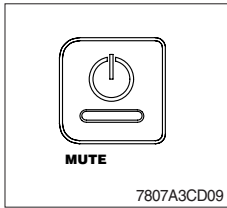

① POWER ON/OFF

Press  to switch on the set. Press  for more than 2 seconds to switch off the set.

② MUTE (Silence)

Short press  key to mute or cancel the mute(silence).

※ **The silence period may be interrupted by ALARM announcement or traffic announcement messages (If TA is switched on).**

(2) Volume button

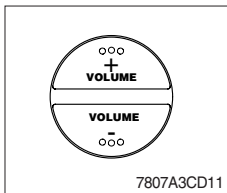

① Press the volume button up/down to adjust the volume.

Please make sure you can still hear the traffic (horns, sirens..).

(3) Sound button

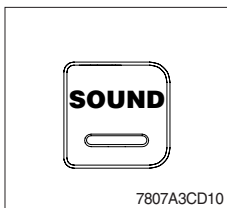

① SOUND

Whether you listen to Jazz, Vocal, Pop, Classic or Rock music, the SOUND button is the perfect setting for your choice.

- Press SOUND then the sound button to select BASS-Treb for your own sound style, or adjust the settings with the volume up/down buttons to select one of the pre define sound styles:

	- BASE -TRE	: Your own settings of bass and treble.
	- FLAT	: Original
	- JAZZ	: Jazz music
	- VOCAL	: Speech
	- POP	: Pop music
	- CLASSIC	: Classical music
	- ROCK	: Rock music

② AUDIO SETTING

- Press SOUND to select desired audio mode.
- Adjust the settings with the volume up/down buttons :

	- Sound style	: BASS-TRE, FLAT, JAZZ, VOCAL, POP, CLASSIC, ROCK
	- BASS	: Low notes
	- TREBLE	: High notes
	- BALANCE	: Left-right
	- FADER	: Rear-front
	- LOUD	: OFF, LOW, MID, HIGH

- Press the volume button to adjust the selected audio mode. After 5 seconds the display goes back to the last mode of operation. Adjustment of Bass and Treble settings is only possible when BASS-TRE is selected as the sound style.

■ RADIO

(1) Wave band / Automatic search button

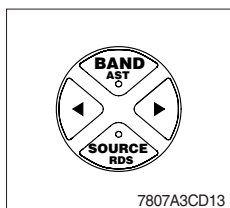

① WAVEBAND

- Press BAND to select the desired band:

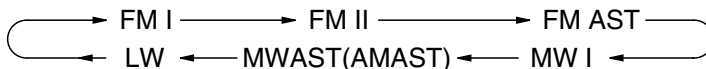

② AUTOMATIC SEARCH

Use search tuning to automatically search for a station.

- Press ◀ to tune a station of a lower frequency or ▶ to a higher frequency.
- To search for another station, press the key again.

③ MANUAL TUNING (If you know the frequency of the required station)

- To switch to manual tuning :
Long press the search button ◀ or ▶ for more than 2 seconds will switch the tuning to manual tuning.
- Then press ◀ to tune to a station of a lower frequency or ▶ to a higher frequency.
- When keys are released, a time-out start to count. After 5 seconds time-out, display 'Auto' for one second and return to automatic search.

(2) Preselected button

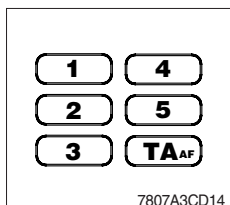

Preselected stations

① Manually storing stations in a preset

Five stations per band can be stored and recalled using the preset keys (1 to 5).

Tune in to the desired station.

- Press the desired preset key (1 to 5) for more than 2 seconds to store the current tuned station.

When storing an FM station, the current program station name and the AF mode are stored on the preset (Some stations use alternating program service name).

② Recalling a preset

Press the desired preset key (1 to 5) to recall the stored station.

③ Automatically storing stations (AUTO-STORE)

You can automatically store 5 strongest FM stations on the FM AST band or 5 strongest MW (AM) stations on the MW (AM) AST band. When you use Auto store, the new stations replace any stations previously stored in the FM AST band or the MW (AM) AST band.

- Press AST to activate autostore.
- The set gives a beep and then mutes.
- When it has finished, you hear a beep followed by the station stored on preset 1.
- Sometimes it may not be possible to find 5 stations.

■ RADIO DATA SYSTEM (RDS) ON FM



More and more stations broadcasts RDS informations in order to offer you many advantages including:

(1) Program service name (PS)

Allows the radio to display the name of the station instead of its frequency.

(2) Automatic returning (AF)

The set remains tuned to the current station by continually searching the best alternative frequency for best reception.

You can switch AF off.

- Activate/Deactivate AF

This set continuously search for other alternative frequencies for the tuned radio station and automatically selects the best frequency for reception. Long press  for more than 2 second to activate/deactivate AF.

(3) Alarm messages (PTY ALARM)

This set automatically receives emergency messages made by the broadcaster.

- During the messages the display shows 'ALARM' and the station-name alternately.

(4) Traffic announcements (TA)

You can activate the TA modes to give priority so as to hear traffic announcements related to these subjects (even if you play a cassettes/CD or mute the set).

- Activate/Deactivate TA
- Short press BAND to select an FM band.
- Press  to activate/deactivate TA.

- If you activate TA mode

- You will hear the traffic announcements when broadcast by station (even if you play a cassette/CD or mute the set).

- If the tuned station does not enable the reception of traffic announcements, the display shows 'NO TA'. The radio automatically searches and appropriate station.

- Interrupting traffic announcement mode

If you do not wish to continue listening to a particular traffic announcement

- Short press  key to interrupt traffic announcement without switching off the mode
- The set will return to the previous operating mode.

※ You can switch off RDS features if not required.

- Long press RDS key to switch off RDS.

- All RDS related features e.g., TA, etc...will be deactivated when RDS is switch off.

■ CASSETTE PLAYER

(1) Winding/Rewinding button

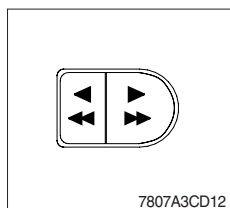

- ※ Only use good quality cassettes.
- ※ To avoid possible tape damage always take out the cassette after use. Protect your cassettes. Put them back in their boxes immediately after use.
- ※ Never expose cassettes to heat or direct sunlight.

① Play back

Slide the cassette, with the open side to the right into the cassette opening. Playback starts.

The direction of playback is shown by indicator ► .

② Stopping playback (▲)

- To stop playback, Press the ▲ button fully home.
- The unit will switch over to radio reception.
- The cassette is partially ejected.

③ Reverse (before the end of the tape)

Press the ◀◀ and ▶▶ buttons at the same time halfway in.

④ Fast rewind / Fast forward (◀◀ or ▶▶)

The direction of fast winding depends on the direction of play indicated on the display.

Display during playback	Action	Key to press
▶	Fast forward	▶▶
▶	Fast rewind	◀◀
◀	Fast forward	◀◀
◀	Fast rewind	▶▶

During fast forward or rewind the radio resumes. If you continue fast winding until the end of the tape, play back restarts automatically.

⑤ To stop fast winding

To stop fast winding before the end of the tape, press the key which is not pressed(◀◀ or ▶▶). Playback is then resumed.

⑥ End of the tape

At the end of the tape, playback continues in the reverse direction.

⑦ Maintenance

After extended use of the cassette player, dust, contamination or grime can accumulate on the playback head.

This results in diminishing high-note reproduction. This can be remedied using a cleaning cassette (one or twice a month) and playing it through like an ordinary cassette.

■ RADIO SETTING

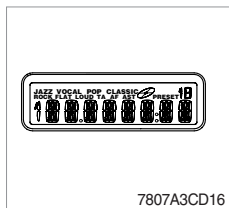

(1) AMERICA

Press , No. 1 and No. 4 buttons at the same time. Set up completes displaying " AMERICA".

(2) SOUTH AMERICA

Press , No. 2 and No. 5 buttons at the same time. Set up completes displaying " SOUTH".

(3) ASIA

Press , No. 1 and No. 5 buttons at the same time. Set up completes displaying " ASIA".

(4) EUROPE

Press power, No. 2 and No. 4 buttons at the same time. Set up completes displaying " EUROPE".