

SPECIFICATIONS

1. MAJOR COMPONENT

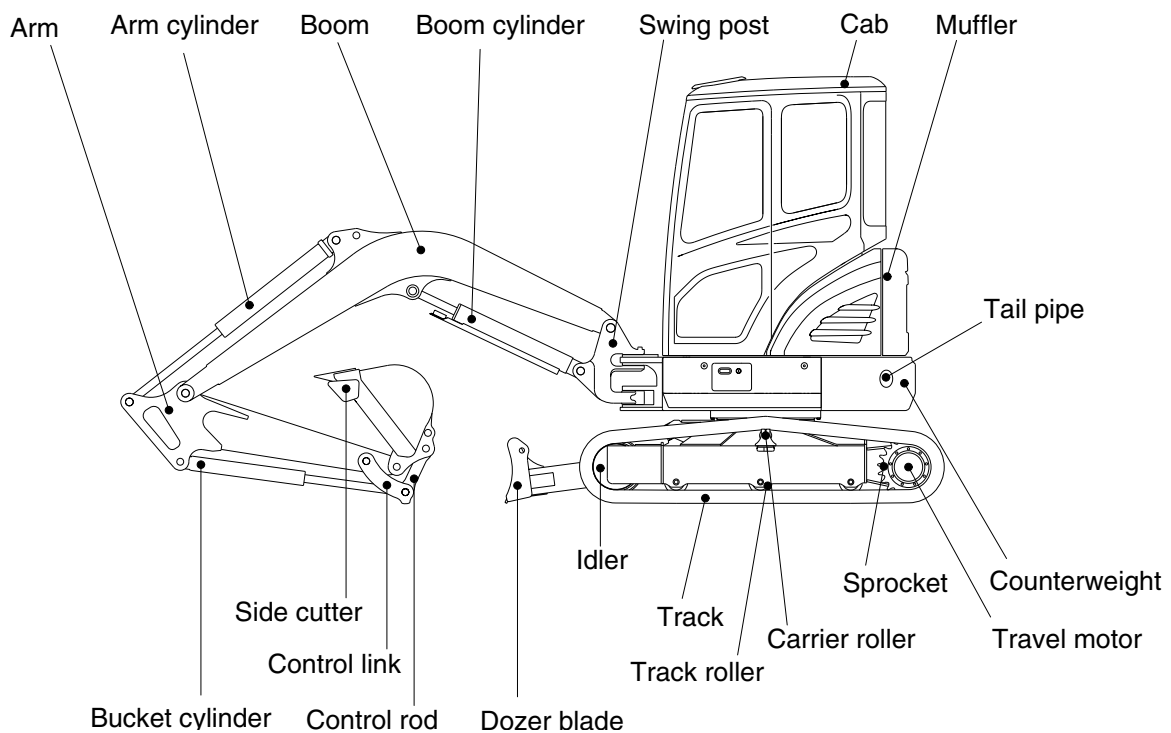
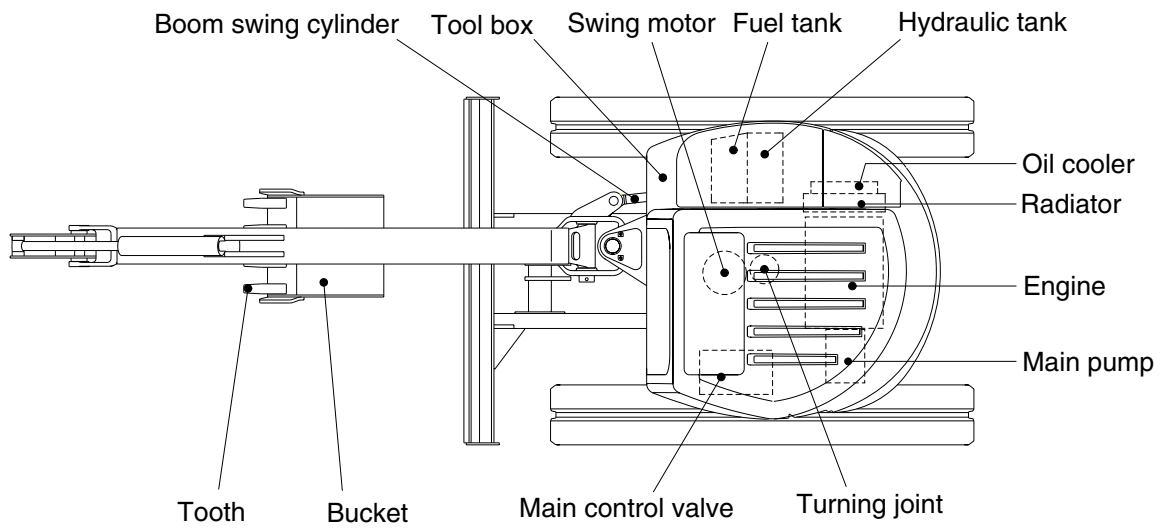

R27Z92SP01