

## 4. LEVERS AND PEDALS

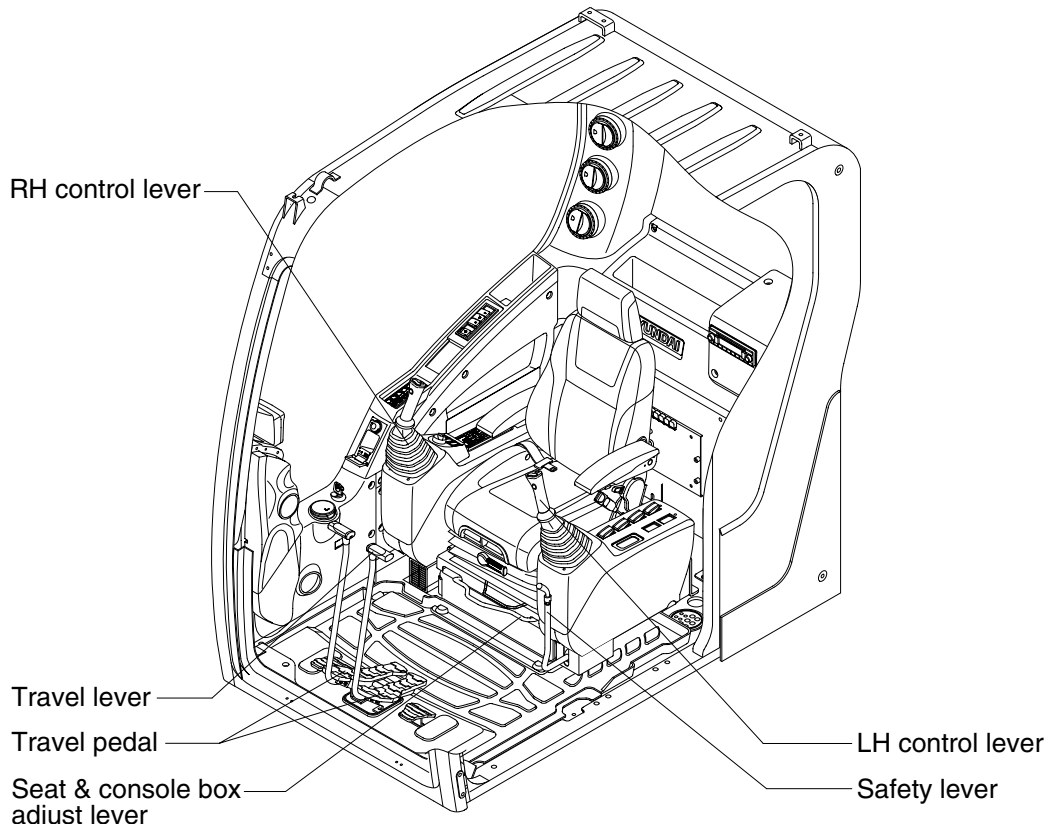

235Z93CD48

### 1) LH CONTROL LEVER

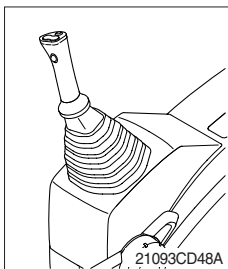

- (1) This joystick is used to control the swing and the arm.
- (2) Refer to operation of working device in chapter 4 for details.

### 2) RH CONTROL LEVER

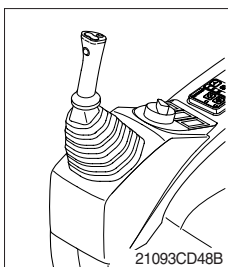

- (1) This joystick is used to control the boom and the bucket.
- (2) Refer to operation of working device in chapter 4 for details.

### 3) SAFETY LEVER

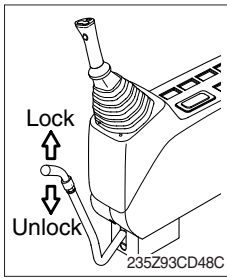

- (1) All control levers and pedals are disabled from operation by locating the lever to lock position as shown.
  - ※ **Be sure to lower the lever to LOCK position when leaving from operator's seat.**
- (2) By pull lever to UNLOCK position, the machine is operational.
  - ※ **Do not use the safety lever for handle when getting on or off the machine.**

### 4) TRAVEL LEVER

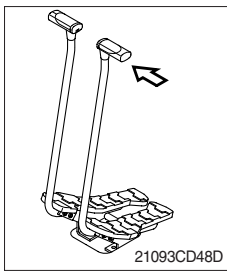

- (1) This lever is mounted on travel pedal and used for traveling by hand. The operation principle is same as the travel pedal.
- (2) Refer to traveling of the machine in chapter 4 for details.

### 5) TRAVEL PEDAL

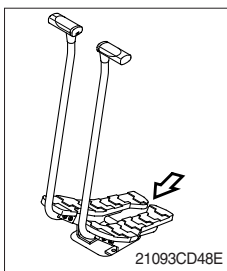

- (1) This pedal is used to move the machine forward or backward.
- (2) If left side pedal is pressed, left track will move.  
If right side pedal is pressed, right track will move.
- (3) Refer to traveling of machine in chapter 4 for details.

### 6) SEAT AND CONSOLE BOX ADJUST LEVER

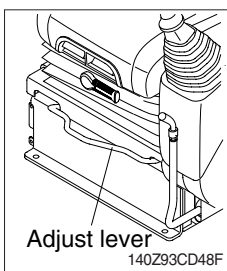

- (1) This lever is used to move the seat and console box to fit the contours of the operator's body.
- (2) Pull the lever to adjust forward or backward over 170mm(6.7").