

CONTROL DEVICES

1. CAB DEVICES

1) The ergonomically designed console box and suspension type seat provide the operator with comfort.

2) ELECTRONIC MONITOR SYSTEM

- (1) The centralized electronic monitor system allows the status and conditions of the machine to be monitored at a glance.
- (2) It is equipped with a safety warning system for early detection of machine malfunction.

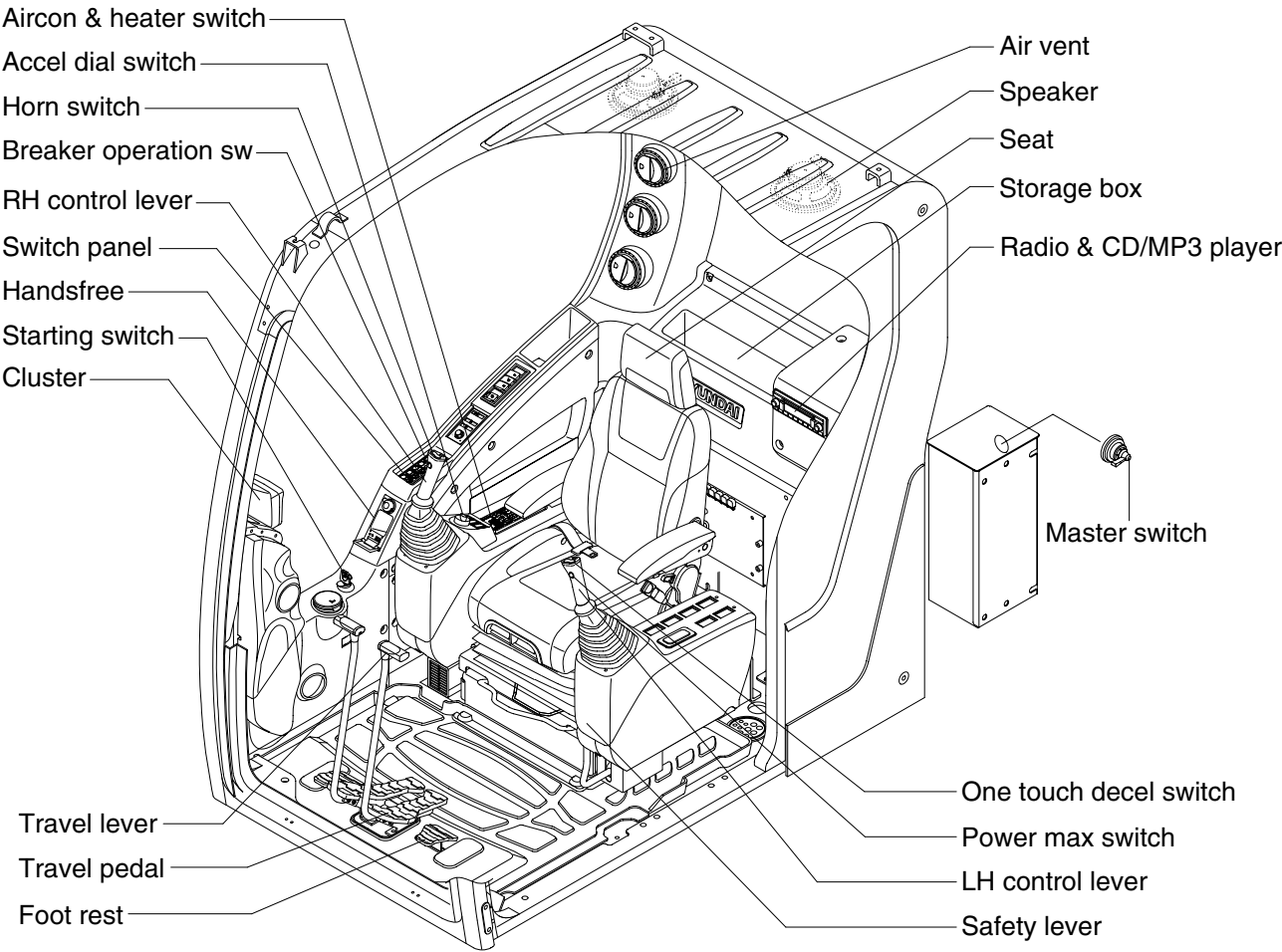

235Z93CD01