

# SPECIFICATIONS

## 1. MAJOR COMPONENT

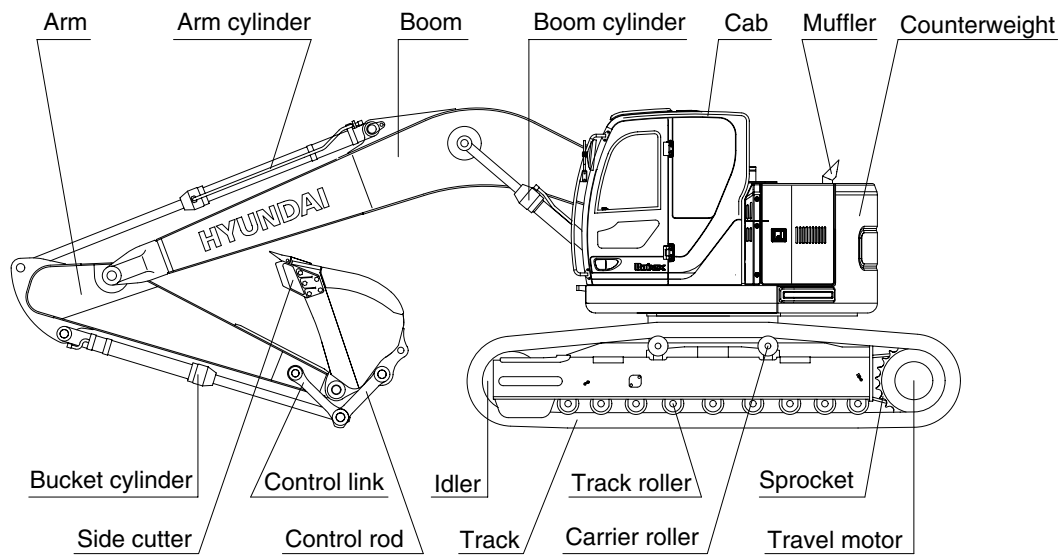
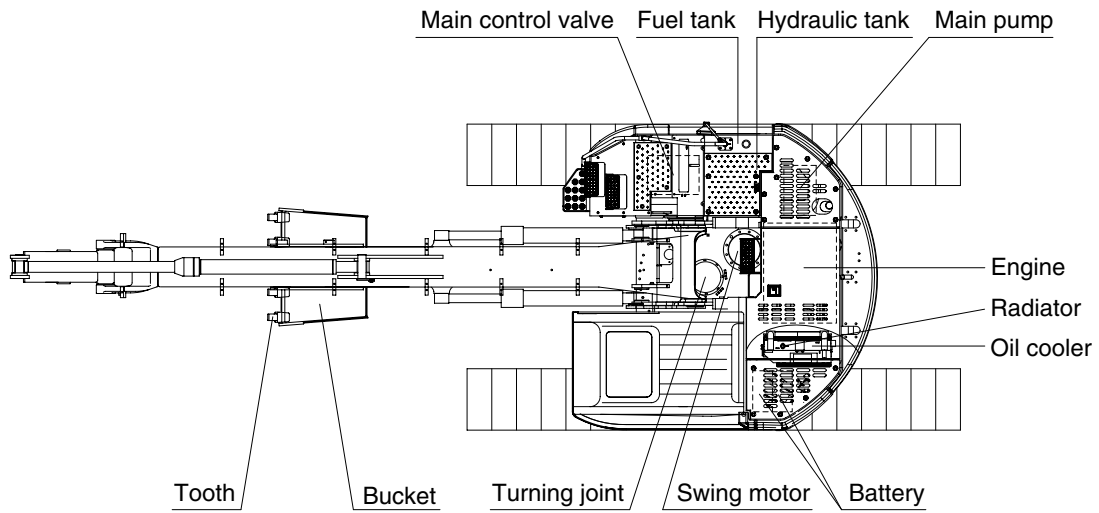

235Z92SP01