

3. STARTING AND STOP THE ENGINE

1) CHECK INDICATOR LIGHTS

- (1) Check if all the operating lever is on the neutral position.
- (2) Turn the starting switch to the ON position, and check following.
 - ① If all the lamps light ON and buzzer sounding for 2 seconds.
 - ② After lamp check **CL : 2.0** , the version of cluster program, is displayed on **Monitoring display(3)** for 5 seconds and the cluster returns to default.
 - ③ Only below lamps will light ON and all the other lights will turn OFF after 2 seconds.
 - Battery charging warning lamp(2)
 - Engine oil pressure warning lamp(1)

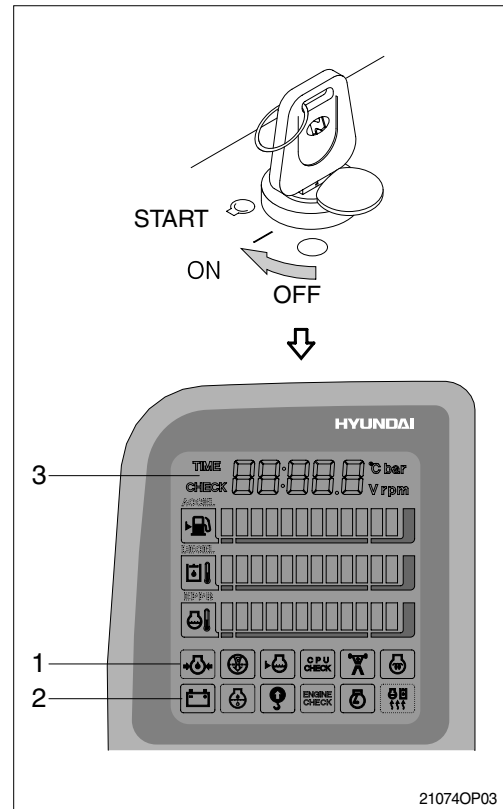

2) STARTING ENGINE IN NORMAL TEMPERATURE

※ Sound the horn to warn the surroundings after checking if personnel or obstacles are in the area.

- (1) Turn the starting switch to START position to start the engine.
 - ※ If the engine does not start, allow the starter to cool for about 2 minutes before attempting to start the engine again.
- (2) Release the starting switch instantly after the engine starts to avoid possible damage to the starting motor.

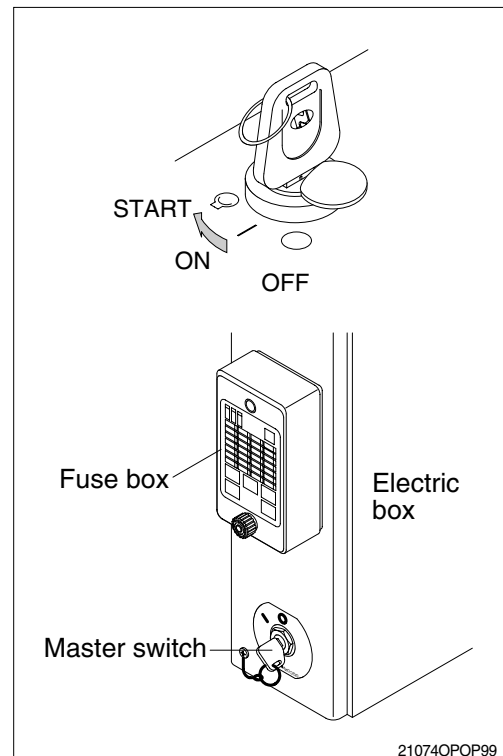

3) STARTING ENGINE IN COLD WEATHER

- ※ Sound horn to warn surroundings after checking if there are obstacles in the area.
- ※ Replace the engine oil and fuel referring to recommended oils at page 2-26.
- ※ Fill the anti-freeze solution to the coolant as required.

- (1) Check if all the levers are on the neutral position.
 - (2) Turn the starting switch to ON position, and wait the preheat pilot lamp OFF.
 - (3) Start the engine by turning the starting switch to the START position after the preheat pilot lamp OFF.
- ※ If the engine does not start, allow the starter to cool for about 2 minutes before attempting to start the engine again.
- (4) Release the starting switch immediately after starting engine.
 - (5) The operation for the warming up machine is automatic.

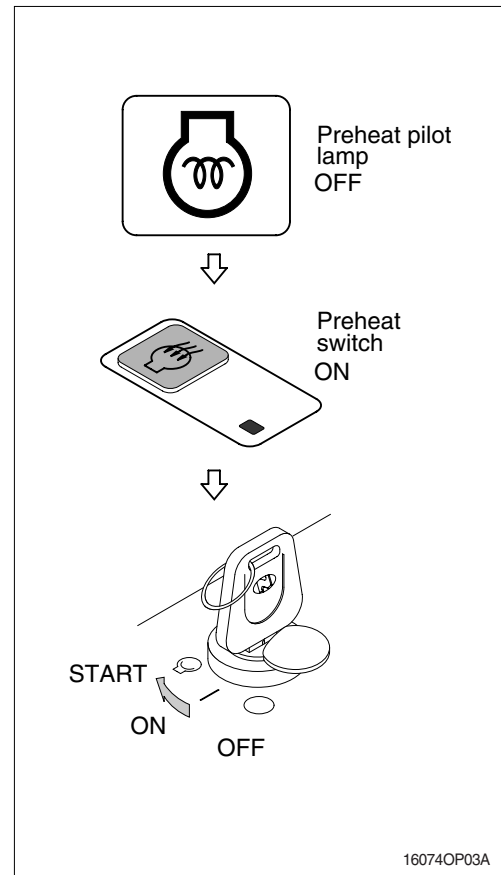

4) INSPECTION AFTER ENGINE START

Inspect and confirm the following after engine starts.

- (1) Is the level gauge of hydraulic oil tank in the normal level?
 - (2) Are there leakages of oil or water?
 - (3) Are all the warning lamps OFF(1-8)?
 - (4) Is the indicator of engine coolant temperature gauge(9) and hydraulic oil temperature gauge(10) in the green zone?
 - (5) Is the engine sound and the color of exhaust gas normal?
 - (6) Are the sound and vibration normal?
- ※ Do not increase engine speed quickly after starting, it can damage engine or turbocharger.
 - ※ If there are problems in the control panel, stop the engine immediately and correct problem as required.

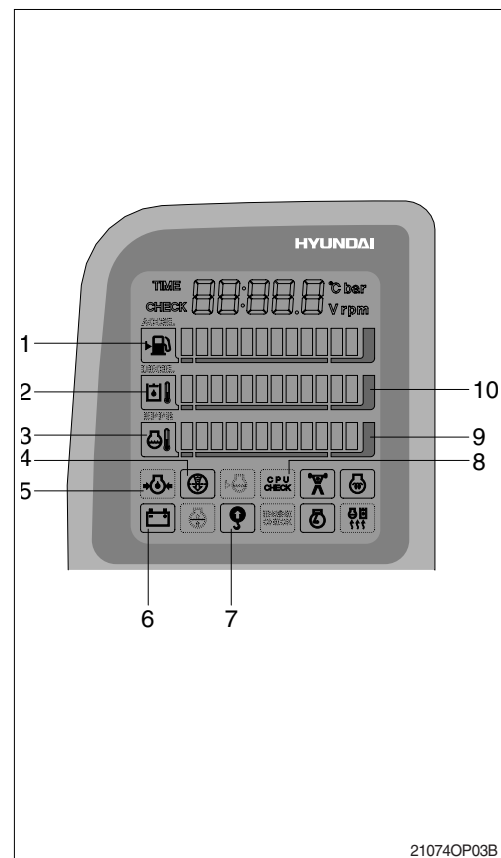

5) WARMING-UP OPERATION

※ The most suitable temperature for the hydraulic oil is about 50°C (122°F).

It can cause serious trouble in the hydraulic system by sudden operation when the hydraulic oil temperature is below 25°C(77°F).

Then temperature must be raised to at least 25°C (77°F) before starting work.

- (1) Run the engine at low idling for 5 minutes.
- (2) Speed up the idling and run the engine at mid-range speed.
- (3) Operate bucket lever for 5 minutes.
※ **Do not operate anything except bucket lever.**
- (4) Run the engine at the high speed and operate the bucket lever and arm lever for 5-10 minutes.
※ **Operate only the bucket lever and arm lever.**
- (5) This warming-up operation will be completed by operation of all cylinders several times, and operation of swing and traveling.
※ **Increase the warming-up operation during winter.**

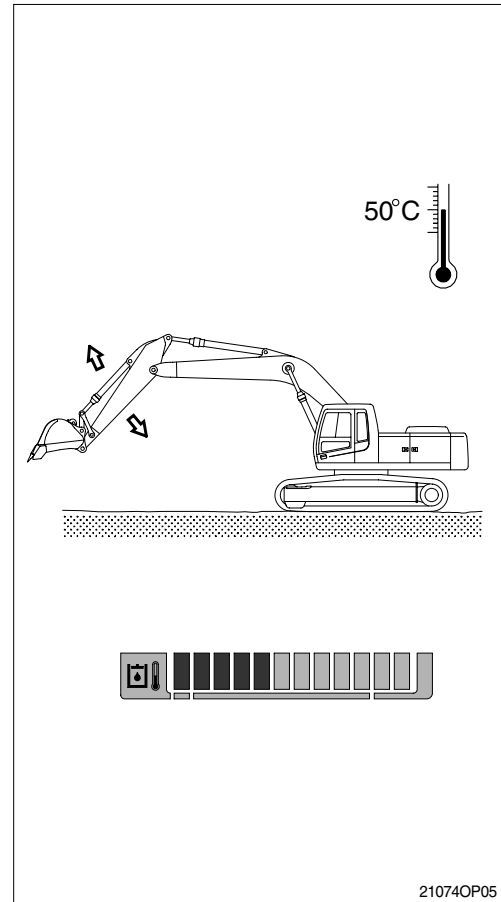

6) TO STOP THE ENGINE

※ If the engine is abruptly stopped before it has cooled down, engine life may be greatly shortened. Consequently, do not abruptly stop the engine apart from an emergency.

※ In particular if the engine has overheated, do not abruptly stop it but run it at medium speed to allow it to cool gradually, then stop it.

- (1) Down the bucket on the ground then put all the levers in the neutral position.
- (2) Run the engine at low idling speed for about 5 minutes.
- (3) Return the key of starting switch to the OFF position.
- (4) Remove the key to prevent other people using the machine and LOCK safety lever.
- (5) Lock the cab door.

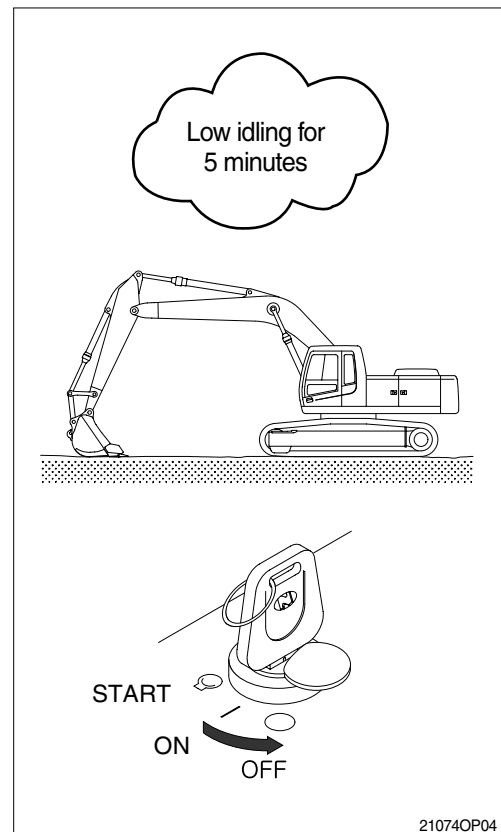

7) OPERATION IN CASE OF MALFUNCTION OF THE CPU CONTROLLER

※ The following explains the way to start and to control engine speed in case of malfunction of the CPU controller.

(1) Emergency starting engine

- ① If the CPU controller is removed, the engine does not start.
- ② Before starting the engine, connect the connector CN-92 A with B.

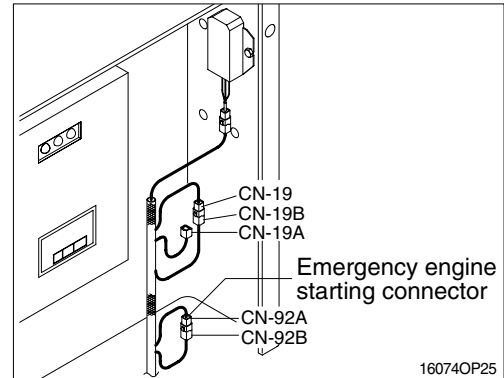

(2) Engine speed control

Engine speed can be controlled as following.

- ① Disconnect the CN-19A from CN-19 connector.
- ② Connect the CN-19 connector to CN-19B.
- ③ Engine speed controlled by emergency engine acceleration lever if equipped located underneath the seat.
- ④ Move the lever up to increase engine RPM.
Move the lever down to decrease engine RPM.

