

6. OTHERS

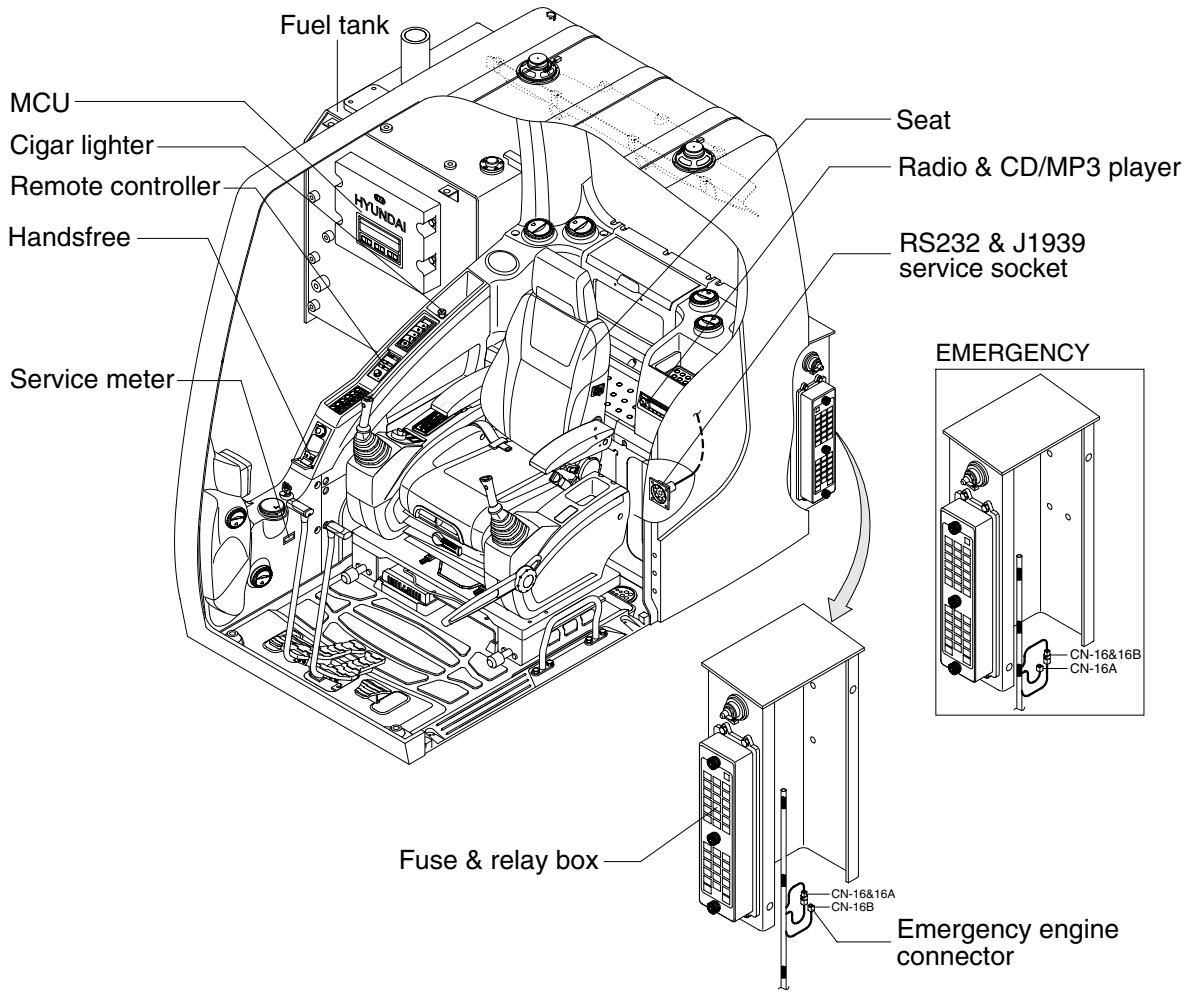

210N93CD50

1) CIGAR LIGHTER

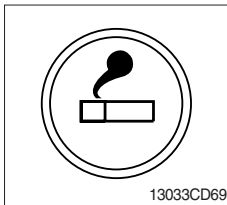

- (1) This can be used when the engine starting switch is ON.
- (2) The lighter can be used when it springs out in a short while after being pressed down.

※ **Service socket**

Use cigar lighter socket when you need emergency power.

Do not use the lighter exceeding 24V, 100W.

2) HANDSFREE

Allow you to dial a call or to have a conversation without holding your handset. Use the remote controller when making and answering a calls or ring off.

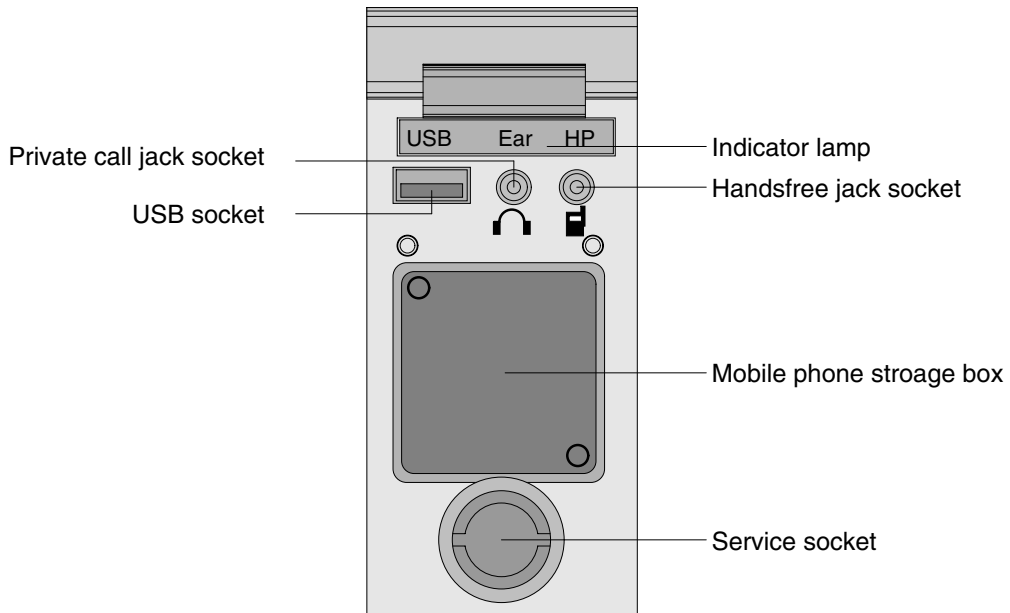

21093CD51

(1) Mobile phone storage box

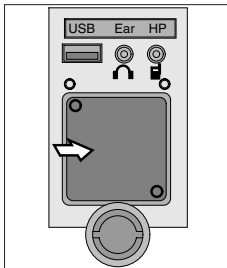

21093CD51A

- ① Mobile phone can be stored when call by handsfree.

(2) USB socket

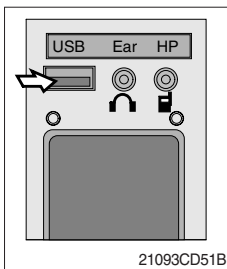

21093CD51B

- ① This socket is used to charging the mobile phone.

(3) Private call jack socket

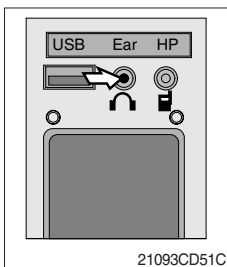

21093CD51C

- ① This can be used protect you privacy calling by using ear phone.
- ② The mobile phone must be connected handsfree jack socket.

(4) Handsfree jack socket

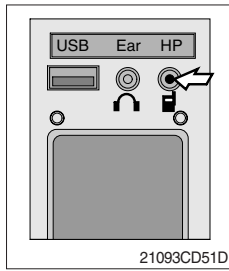

- ① Connect the jack cable when call by handsfree.
- ② Use the special adapter when jack cable is not interchangeable.
- ③ Check the jack type of mobile phone before use.

(5) Indicator lamp

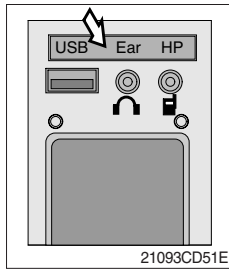

- ① This lamp is turned ON when the handsfree mode selected.

(6) Service socket

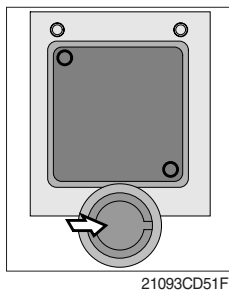

- ① Utilize the power of 12 V as your need and do not exceed power of 12 V, 30 W.

3) REMOTE CONTROLLER

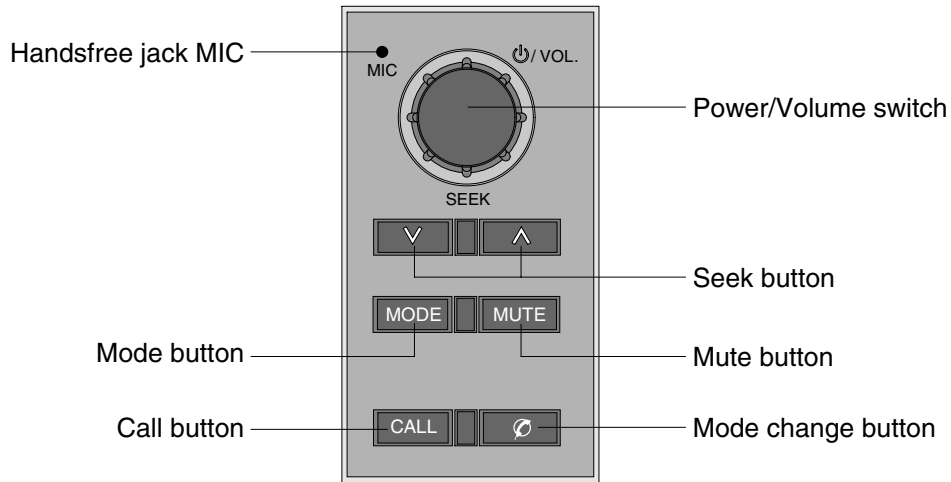

21093CD52

(1) Power and volume switch



21093CD52A

- ① This switch is used to turn the audio or handsfree ON or OFF.
 - ② This switch is turned to right, the handsfree volume is increased over 7 steps.
 - ③ If it is turned to left, volume will be decreased.
- ※ This switch adjust the audio volume when selected audio mode.

(2) Mode change button



21093CD52B

- ① This button is to select the handsfree mode or audio mode.
 - Lamp ON : Handsfree mode ("TEL MUTE" displayed ON audio LCD)
 - Lamp OFF : Audio mode

(3) Call button

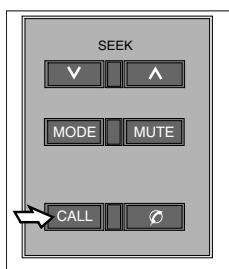

21093CD52C

- ① This button is used answer a call, last number redial, ring off.
 - ② For calling, press the button over 0.5sec within 3 seconds until the beep sounds.
- ※ This can be used when the starting switch is ON.

(4) Handsfree MIC

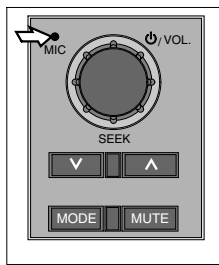



21093CD52D

- ① This MIC transfers user voice to receiver of the call when making a call by handsfree.

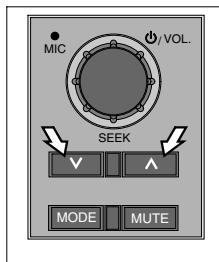
(5) Seek button



21093CD52E

- ① If this button pressed, the radio automatically stops at the next frequency of broadcasting for your listening.
- ② Press  to turn a station of a higher frequency or  to a lower frequency.

(6) Mute button

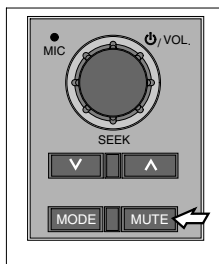

21093CD52G

- ① Short press this button to mute or cancel the mute (silence) while broadcasting.

(7) Mode button



21093CD52F





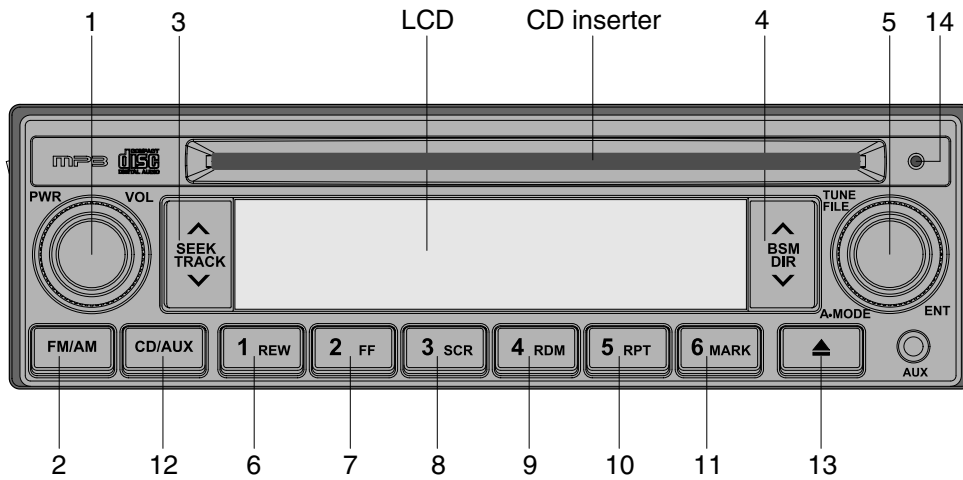







- ① Press the mode button to select the desired mode.
 - ② FM1 → FM2 → AM → CD → MP3 → FM1
- ※ **The LCD displayed each mode.**

4) RADIO AND CD/MP3 PLAYER



21093CD70

■ FRONT PANEL PRESENTATION

- | | |
|---|---|
| <p>1  Power and volume switch
 PWR Press to power on/off
 VOL Turn right/left to adjust the volume</p> <p>2  AM/FM button (radio)</p> <p>3  Seek mode (radio)
 Auto search up/down
 Track mode(CD)
 Short press : Next/previous track
 Long press : Fast forward or rewind
 Memory file search up/down (MP3)</p> <p>4  BSM mode (radio)
 6 best station automatic memory
 DIR mode (MP3)
 Select the desired folder (MP3)
 Long press : Fast forward or rewind</p> <p>5  Manual frequency search (radio)
 Turn right/left to adjust the frequency
 FILE Search for desired file (CD/MP3)
 Turn right/left to adjust the track no
 A · MODE ... Select bass/middle/treble (radio)
 ENT Select the desired track (CD/MP3)</p> | <p>6  Preset memory button 1
 REW Fast rewind (CD)</p> <p>7  Preset memory button 2
 FF Fast forward (CD)</p> <p>8  Preset memory button 3
 SCR Scroll button (CD-MP3)</p> <p>9  Preset memory button 4
 RDM CD random playback on/off</p> <p>10  Preset memory button 5
 RPT CD repeat track on/off</p> <p>11  Preset memory button 6
 MARK Long press : MP3 file memory/deletion
 Short press : Memory file playback</p> <p>12  CD playback button
 Press to CD insert</p> <p>13  Disc eject (CD)</p> <p>14 CD indicator lamp</p> |
|---|---|

■ RADIO

(1) Power and volume switch

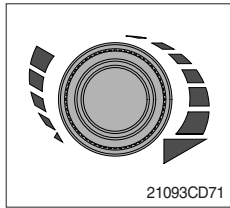

① **Power ON/OFF**

This switch is used to turn the audio ON or OFF.

② **Volume**

This switch turned to right or left, the sound is increased or decreased.

(2) FM/AM button

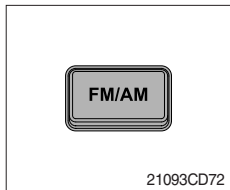



① You can broadcasting on AM or FM band by pressing this band selection button.

② The bands are changed in the following order.
FM1 → FM2 → AM → FM1

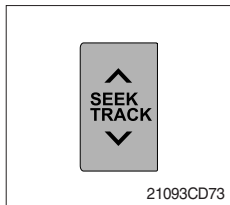
(3) Seek button



① If this button pressed, the radio automatically stops at the next frequency of broadcasting for your listening.

② Press  to turn a station of a higher frequency or  to a lower frequency.

(4) BSM (best station memory) button

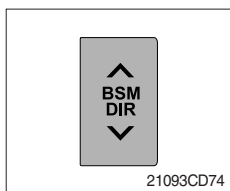

① You can automatically memory 6 strongest FM stations on the FM BSM band or 6 strongest AM stations on the AM BSM band.

- Press BSM to active best station memory.
- The set gives a beep and then mutes.
- When it has finished, you heard a beep followed by the station memoried on preset 1.
- Sometimes it may not be possible to find 6 stations.

(5) Manual tuning/audio mode button

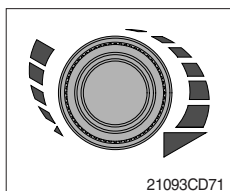

① It is possible to change manual tuning while broadcasting.

- Turned to right or left, the frequency is increased or decreased.

② **Audio mode** (Bass/Middle/Treble)

- Press this button to select desired audio mode.
- Adjust the settings with the volume button right/left.
 - BASS : Press the button once
 - MIDDLE : Press the button twice
 - TREBLE : Press the button three times

③ If it is pressed four times, BALANCE will be selected.

- Turned to clockwise, the LH speaker volume is decreased and counterclockwise, the RH speaker volume is decreased.

(6) Preset memory button

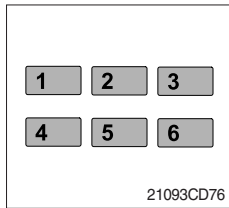

① Manually storing stations in a preset

Six stations per band can be stored and recalled using the preset keys (1 to 6).

- Tune in to the desired station.
- Press the desired preset key (1 to 6) for more than 0.8 seconds to store the current tuned station.

② Recalling a preset

Press the desired preset key (1 to 6) to recall the stored station.

(7) Frequency band setting

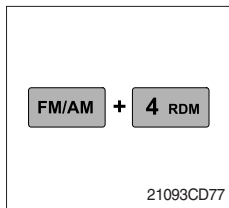

- ① America : Press **FM/AM** and **4 RDM** button at the same time. "nA" will be displayed on the LCD for one second.

AM : Frequency changes in 10kHz between 530 to 1710kHz.

FM : Frequency changes in 0.2MHz between 87.7 to 107.9MHz.

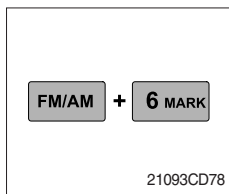

- ① EUROPE : Press **FM/AM** and **6 MARK** button at the same time. "Eu" will be displayed on the LCD for one second.

LW : Frequency changes in 9kHz between 153 to 279kHz.

MW : Frequency changes in 9kHz between 531 to 1620kHz.

FM : Frequency changes in 0.05MHz between 87.5 to 108.0MHz.

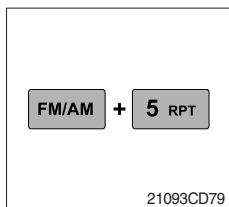

- ① General : Press **FM/AM** and **5 RPT** button at the same time. "inT" will be displayed on the LCD for one second.

AM : Frequency changes in 9kHz between 531 to 1602kHz.

FM : Frequency changes in 0.1MHz between 87.5 to 108.0MHz.

■ CD/MP3 PLAYER

(1) CD playback button

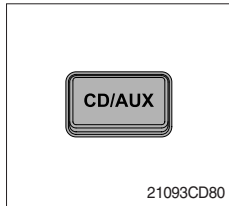

- ① It is possible to change CD playback during broadcasting.
- ② If there was no CD on audio, "NO DISC" displays on LCD during 5 seconds.

(2) Track button

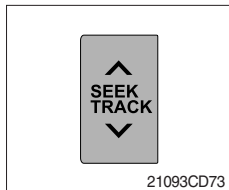

- ① **CD player**
 - Short press : Select the next/previous track
 - Long press : Select the fast forward or rewind
- ② **MP3 player**
 - Memory file search up/down

(3) DiR mode button (MP3)

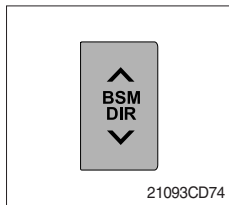

- ① You can find the desired mp3 folder up/down.
- ② If you find desired folder, press the file search button to playback the first file in the folder.
 - ※ **If a file is not selected until 5 seconds after search folder, the function will be terminated.**

(4) File search button

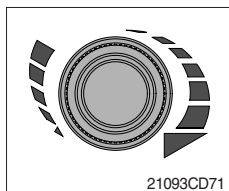

- ① It is possible to search the desired CD track or mp3 file.
 - Turned to clockwise, the CD track or mp3 file number is increased.
 - If it is turned to counterclockwise, CD track or mp3 file number is decreased.
- ※ **If a file or track is not selected until 5 seconds, function will be terminated.**

(5) Fast rewind/Fast forward button (CD)

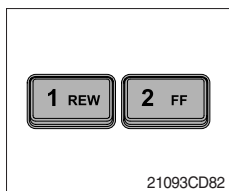

- ① Continually press these button to quickly move rewind or forward through the disc.
 - ※ **The CD player sound level is lower while press this button.**
- ② Normal playback resumes when you release the button.

(6) Random track button (CD)

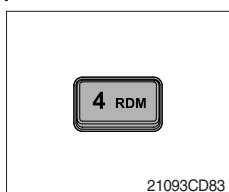

- ① Press this button to activate random track playback.
 - ※ **The LCD displays "RDM".**
- ② It is canceled press one more this button.

(7) Repeat track button (CD)

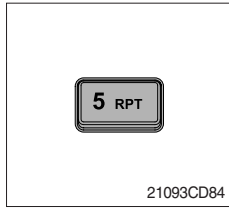

- ① Press this button to activate repeat current track playback.
※ **The LCD displays "RPT".**
- ② It is canceled press one more this button.

(8) Mark button (MP3)



- ① Memory
 - Press over 0.8 second, the current file memorized with a beep (max 100 tune memory).※ **The LCD displays "M" and "Marked number" for 3 seconds.**
- ② **Memory file playback**
 - Press within 0.8 second, the marked file playback.
- ③ **Deletion**
 - Press over 0.8 second, the marked file will be deleted with a beep.

(9) CD EJECT BUTTON

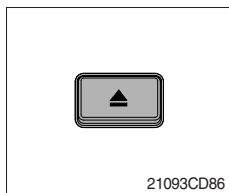

- ① Press this button to eject the disc.
※ **If there is no disc in the audio, the LCD displays "NO disc" for 5 seconds.**

(10) SCR BUTTON (MP3)

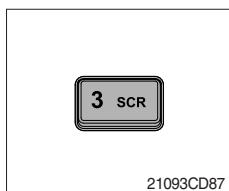

- ① This button to confirm the long file name on LCD.

5) SEAT

The seat is adjustable to fit the contours of the operator's body. It will reduce operator fatigue due to long work hours and enhance work efficiency.

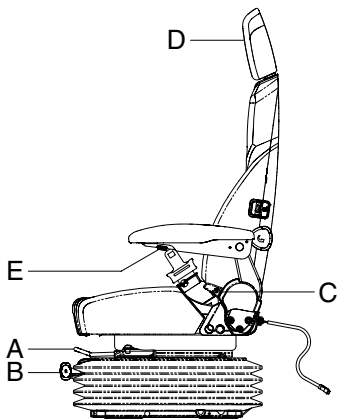
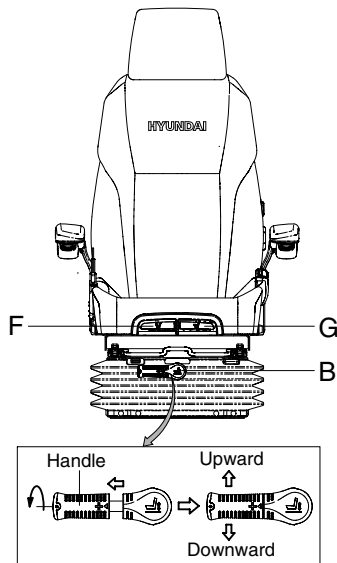

21093CD55

(1) Forward/Backward adjustment (A)

- ① Pull lever A to adjust seat forward or backward.
- ② The seat can be moved forward and backward over 140 mm (5.5") in 13 steps.

(2) Height/weight adjustment (B)

- ① Turn the handle to adjust seat upward or downward
 - Turn to clockwise, the seat is moved to upward and the weight is increased.
 - If it is turned to counterclockwise, the seat is moved to downward and the weight is decreased.

② Method of changing direction (up/down)

- First, pull the handle to outside.
- Second, rotate 180° and release the handle.

(3) Reclining adjustment (C)

Pull lever C to adjust seat back rest.

(4) Arm rest adjustment (E)

This can be adjusted by pushing the button E to right and left.

(5) Head rest adjustment (D)

This is adjustable vertically to fit operator's requirements over 60 mm (2.4").

(6) Seat cushion tilt adjustment (F)

Pull lever F to adjust seat cushion tilting angle over 8°.

(7) Seat cushion length adjustment (G)

▲ Pull lever G to adjust seat cushion forward or backward.

▲ Always check the condition of the seat belt and mounting hardware before operating the machine. Replace the seat belt at least once every three years, regardless of appearance.

8) EMERGENCY ENGINE STARTING CONNECTOR

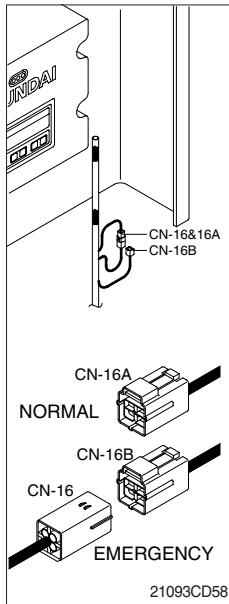

(1) Emergency starting

- ① If the MCU is removed, the engine does not start.
- ② Before starting the engine, connect the connector CN-16 with 16B.

(2) Emergency speed control

- ① When the CAN communication between the ECM and the MCU is abnormal due to malfunction of the MCU, change CN-16 connection from CN-16A to CN-16B and then control the engine speed by rotating accel dial switch.
- ※ **Never connect connector CN-16 with CN-16B when MCU is in normal operation.**

9) SERVICE METER

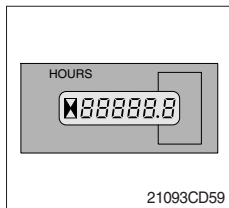

- (1) This meter shows the total operation hours of the machine.
- (2) Always ensure the operating condition of the meter during the machine operation. Inspect and service the machine based on hours as indicated in chapter 6, maintenance.

10) RS232 & J1939 SERVICE SOCKET

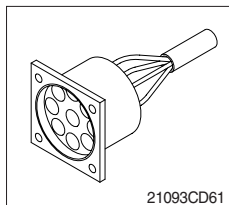

- (1) MCU communicates the machine data with Laptop computer through RS232 service socket.
- (2) ECM communicates the engine data with cummins INSITE adapter through J1939 service socket.
 - ① ECM fault code check
 - ② ECM program change
 - ③ Engine data monitoring & test

11) UPPER WINDSHIELD

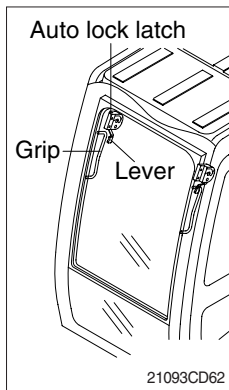

- (1) Perform the following procedure in order to open the upper windshield.
- ① Pull both levers with hold both grips that are located at the top of the windshield frame and push the windshield upward.
 - ② Hold both grips and back into the lock position until auto lock latch is engaged, then release the lever locked position.

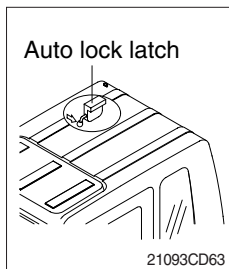

- (2) Perform the following procedure in order to close the upper windshield.
- ① Pull the lever of the auto lock latch in order to release the auto lock latch.
 - ② Reverse above step ① and ② in order to close the upper windshield.