

SPECIFICATIONS

1. MAJOR COMPONENT

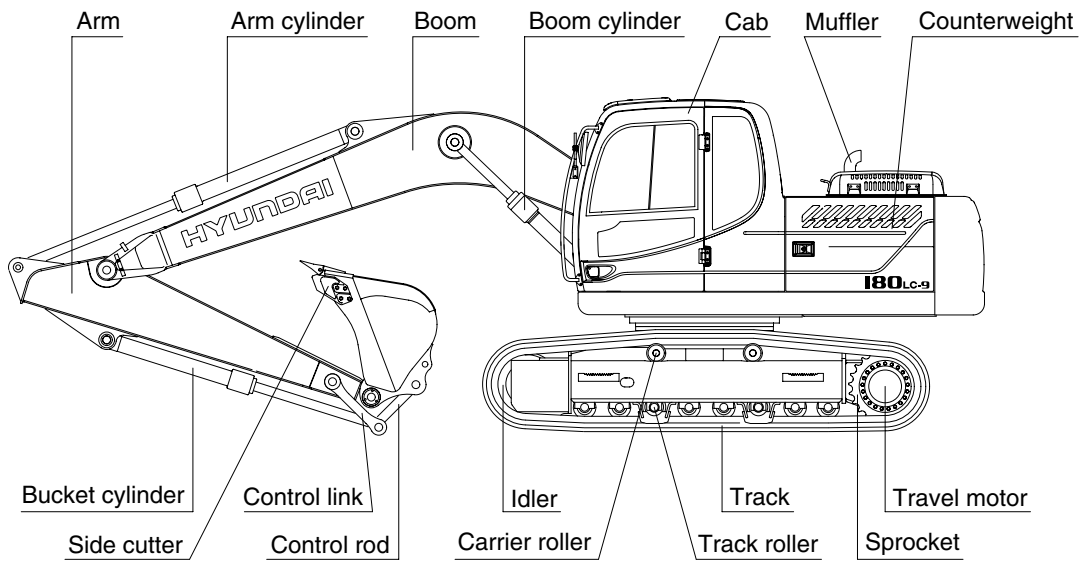
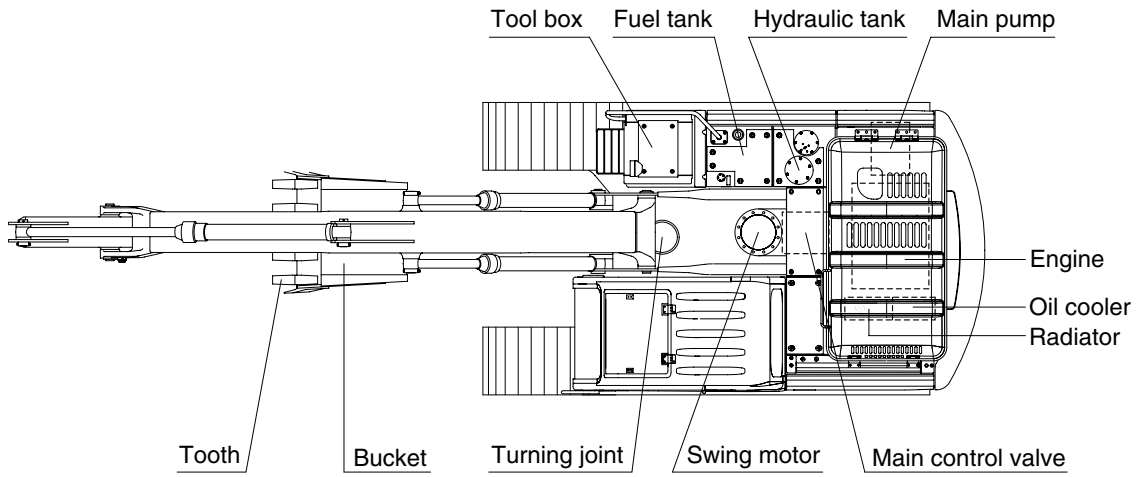

18092SP01