

4. LEVERS AND PEDALS

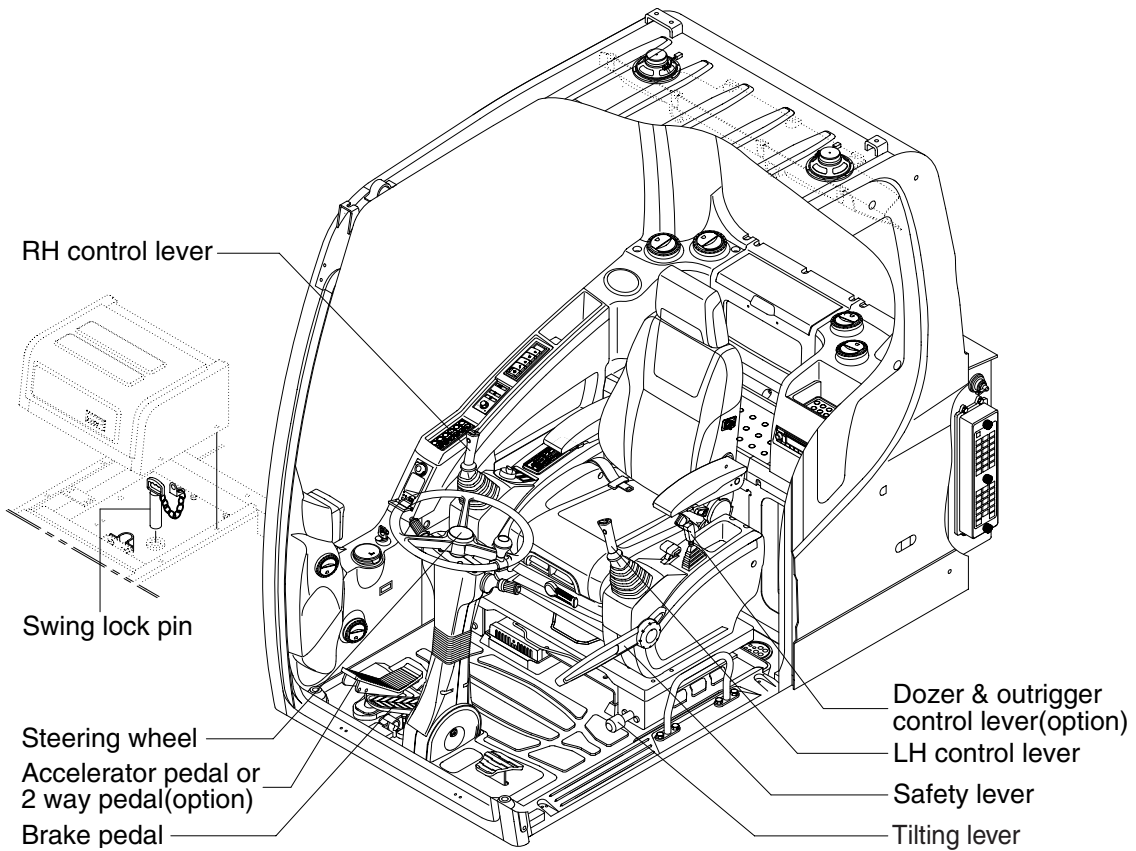

14W93CD48

1) LH CONTROL LEVER

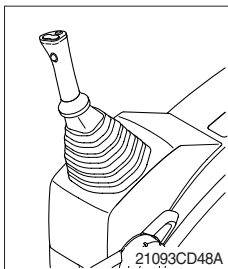

- (1) This joystick is used to control the swing and the arm.
- (2) Refer to operation of working device in chapter 4 for details.

2) RH CONTROL LEVER

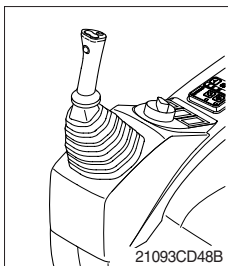

- (1) This joystick is used to control the boom and the bucket.
- (2) Refer to operation of working device in chapter 4 for details.

3) SAFETY LEVER

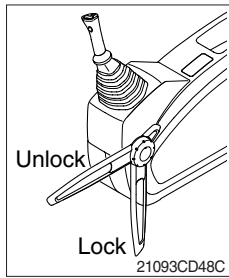

- (1) All control levers and pedals are disabled from operation by locating the lever to lock position as shown.
 - ※ **Be sure to lower the lever to LOCK position when leaving from operator's seat.**
- (2) By pull lever to UNLOCK position, the machine is operational.
 - ※ **Do not use the safety lever for handle when getting on or off the machine.**

4) STEERING WHEEL

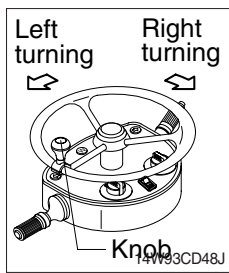

- (1) If the steering wheel is turned to left, the machine will move to the left and turn it to the right, the machine will move to the right.
- (2) As the handle is equipped with a knob, it is convenient to operate with one hand or quickly.

5) DOZER AND OUTRIGGER LEVER

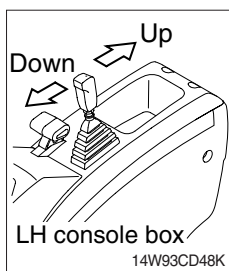

- (1) This lever is used to operate dozer blade or outrigger by selecting the select switch 1 (dozer / outrigger).
 - ※ **Please refer to the select switch 1 (dozer / outrigger) at page 3-25.**
- (2) If the lever is pushed forward, the dozer blade or outrigger will be going down. And if the lever is pulled back, the dozer blade or outrigger will be going up the dozer blade.

6) SEAT AND CONSOLE BOX ADJUST LEVER

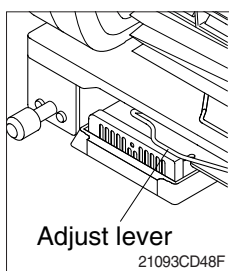

- (1) This lever is used to move the seat and console box to fit the contours of the operator's body.
- (2) Pull the lever to adjust forward or backward over 170 mm (6.7").

7) ADJUSTING LEVER

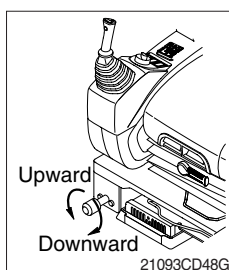

- (1) This lever is used to move the LH and RH control lever to fit the contours of the operator's body.
- (2) The control lever can be moved upward and downward over 30 mm (1.2").

8) ACCELATOR PEDAL

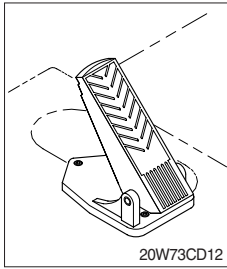

(1) When this pedal is stepped, the machine starts traveling.

▲ Before starting the machine with stepping on the pedal, check if the underframe is certainly in the traveling direction.

9) 2 WAY PEDAL (option)

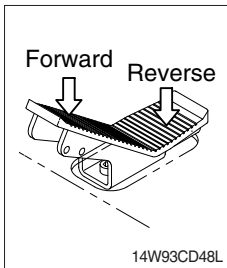

(1) This pedal is used to select traveling direction and to accelerate of the machine.

(2) Push the pedal to front for forward traveling, push the pedal to rear for reverse traveling.

10) BRAKE PEDAL

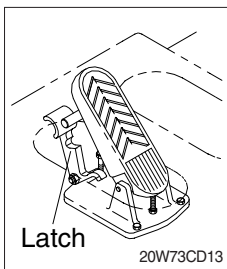

(1) Pedal and latch provide two kinds of service brake function.

(2) To operate service brake, push pedal with latch by foot.

▲ Push pedal and latch at once to avoid unexpected locking of pedal in traveling condition.

▲ During travel, do not push pedal only in full stroke. It is dangerous due to the locking of service brake.

(3) If you want to choose working brake, just push pedal in full stroke without latch then the latch locks pedal and service brake is working continuously until you push the latch to release the pedal.

(4) Push latch to release working brake.

11 SWING LOCK LEVER

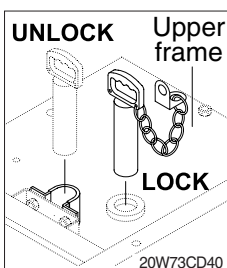

(1) This is the system to lock the swing by connecting the upper swing part and the lower frame mechanically.

(2) The swing is locked when the lever is down and unlocked when the lever is up.

※ Before operating the machine, be sure to unlock the swing lock device.