

SPECIFICATIONS

1. MAJOR COMPONENTS

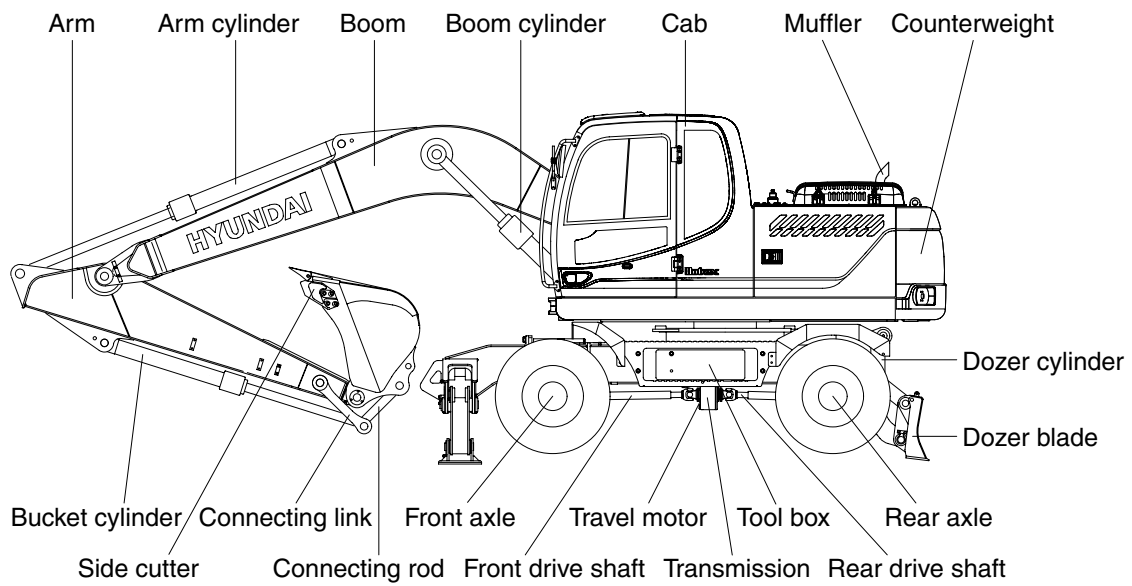
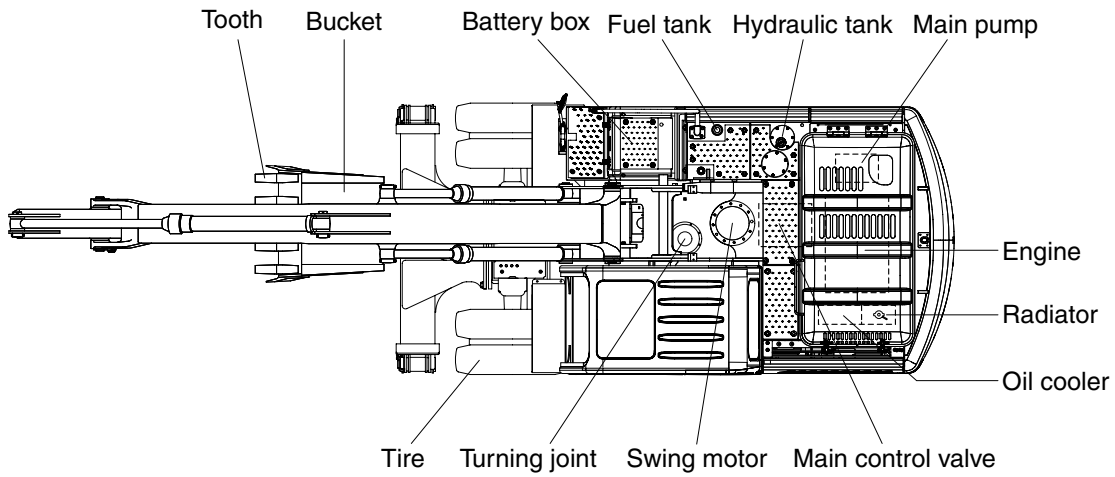

17W92SP01