

4. MODE SELECTION SYSTEM

1) STRUCTURE OF CAPO SYSTEM

CAPO, Computer Aided Power Optimization system, is the name of mode selection system developed by Hyundai.

(1) Work mode

3 work modes can be selected for the optimal work speed of the machine operation.

① Heavy duty work mode

The boom priority solenoid is activated to make the boom operation speed faster.

② General work mode

When key switch is turned ON, this mode is selected automatically and swing operation speed is faster than heavy duty work mode.

③ Breaker operation mode

It sets the pump flow to the optimal operation of breaker by activating the max flow cut-off solenoid.

(2) Power mode

Power mode designed for various work loads maintains high performance and reduces fuel consumption.

- H mode : High power
- S mode : Standard power

(3) User mode

- M : Maximum power
- U : You can change the engine and pump power and memorize it for your preference

How to modulate the memory set

- ① Each memory mode has a initial set which are mid-range of max engine speed, auto decel rpm, and EPPR valve input current.

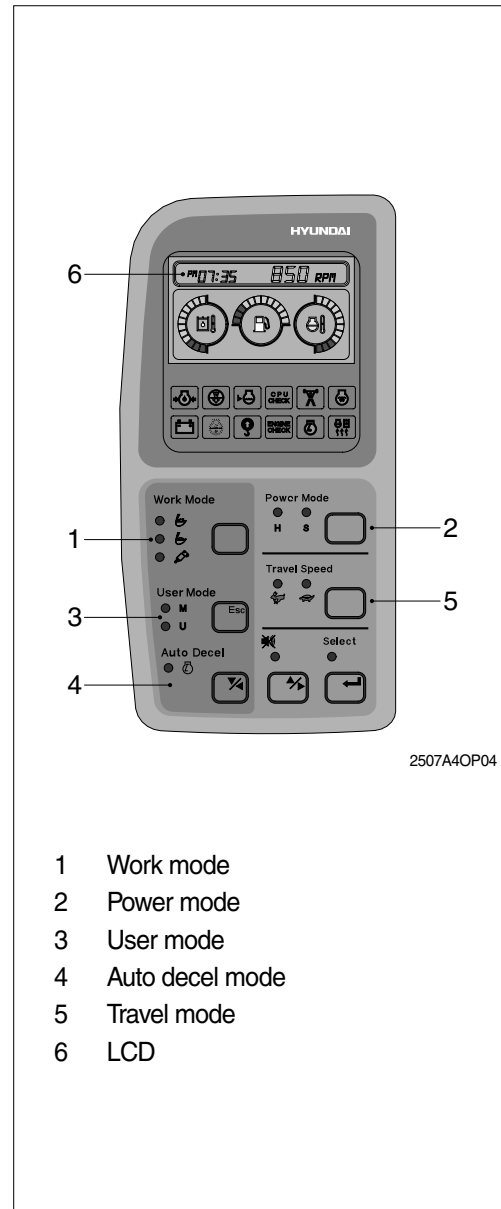

- 1 Work mode
- 2 Power mode
- 3 User mode
- 4 Auto decel mode
- 5 Travel mode
- 6 LCD

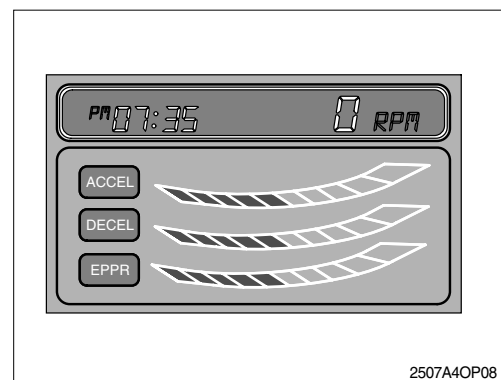

② High idle rpm, auto decel rpm, EPPR pressure can be modulated and memorized separately in the U-mode.

※ Refer to the page 3-8 for set of user mode.

· LCD segment vs parameter setting

Segment ()	ACCEL (rpm)	DECEL (rpm)	EPPR (mA)
1	1550	800	137
2	1600	Low idle(850)	192
3	1650	900	235
4	1700	950	281
5	1750	Decel rpm(1000)	329
6	1800	1050	379
7	1850	1100	428
8	1900	1150	478
9	1950	1200	528
10	2000	1250	638

(4) Auto decel mode

Engine quick deceleration.

(5) Travel mode

 : Low speed traveling.

 : High speed traveling.

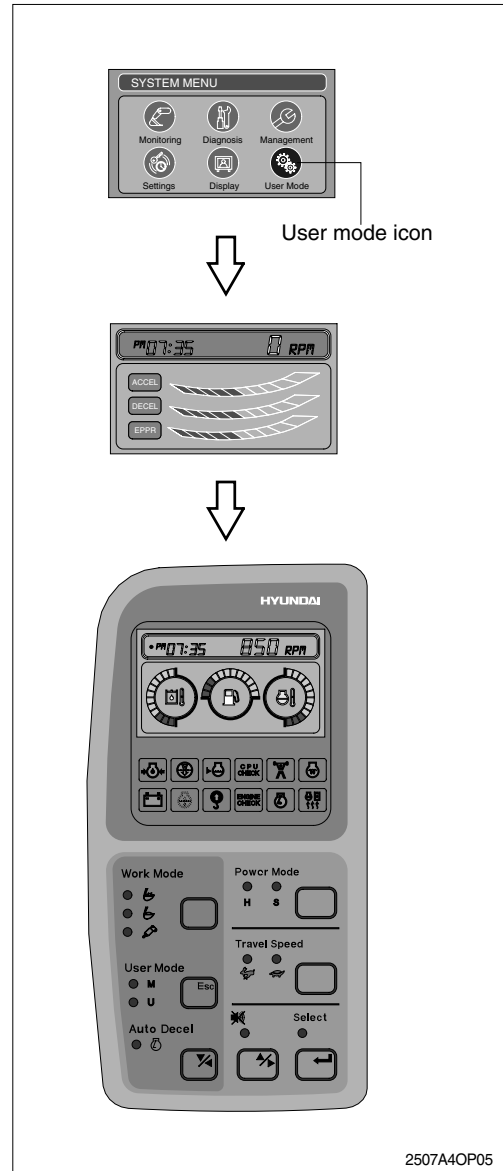

2507A40P05

(6) Monitoring system

Information of machine performance as monitored by the CPU controller can be displayed on the **LCD**. Refer to the page 3-5.

(7) Self diagnostic system

① CPU controller

The CPU controller diagnoses problems in the CAPO system caused by electric parts' malfunction and by open or short circuit, which are displayed on the **LCD** as error codes(2 digit).

② Engine controller(ECU)

If the engine or relevant system has problem ECU diagnoses and displays on the **LCD** as fault codes(3 digit or more).

※ **Consult hyundai or hyundai dealer for details.**

※ **Refer to the page 3-5 for LCD display.**

(8) Anti-restart system

The system protects the starter from inadvertent restarting after the engine is already operational.

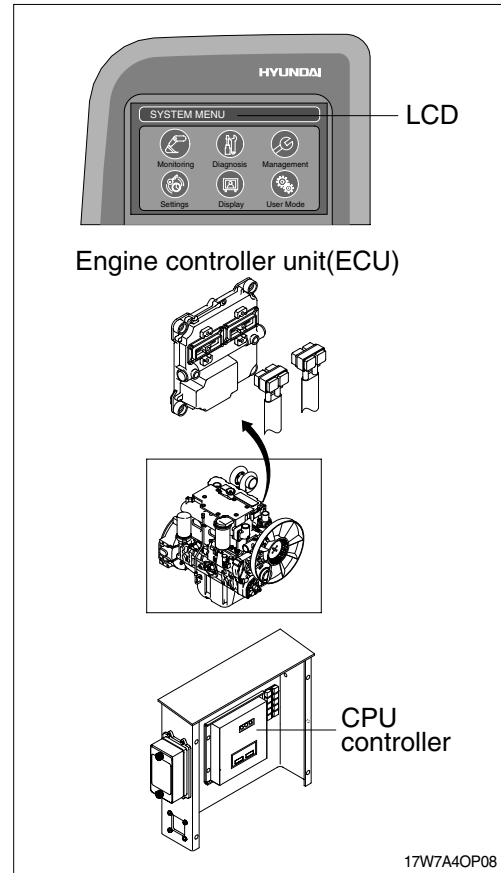

2) HOW TO OPERATE MODE SELECTION SYSTEM

(1) When start key is turned ON

- ① When start key is turned ON, all illumination lamps are ON and all lamps are OFF automatically after 5 seconds. But a battery charging warning lamp and an engine oil pressure warning lamp keep turned ON until engine starting.
- ② After lamp check「1.00」, the version of cluster program, is displayed on **LCD** for 2 seconds.
- ③ After the version of program is displayed, the cluster returns to default. Exactly engine rpm, battery charging warning lamp and engine oil pressure warning lamp are turned ON and S mode, auto decel, low travel speed(Turtle mark) are displayed.
- ④ In default condition self-diagnostic function including trouble detecting of electric system can be carried out.



(2) After engine start

- ① When the engine is started, three lamps are ON as below.

Mode		Status
Work mode		ON
Power mode	S	ON
Travel mode	Low()	ON
Auto decel mode		ON

- In this condition, tachometer indicates low idle, 850 ± 100 rpm.
- If coolant temperature is below 30°C , after 10 seconds the engine speed increases to 1000 ± 100 rpm automatically to warm up the machine.
- After 2-3 minutes, you can select any mode depending on job requirement.

- ② Self-diagnostic function can be carried out the same as start key is ON.

※ Refer to the page 3-5 for details.

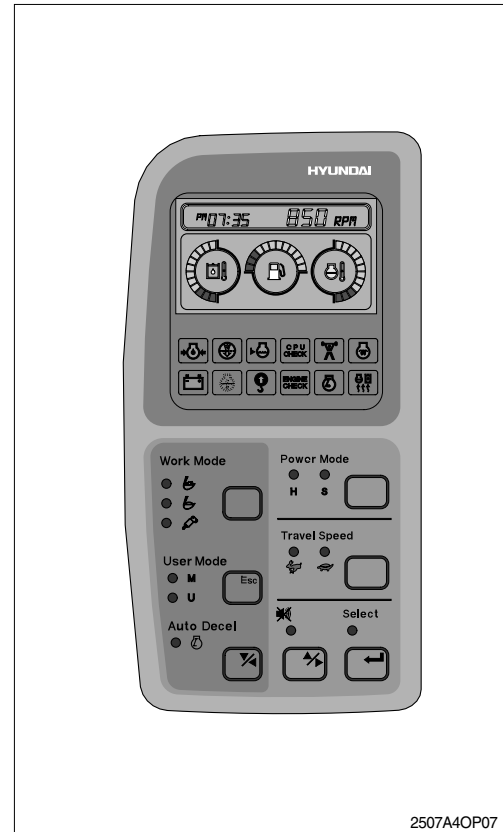

2507A4OP07

3) SELECTION OF POWER MODE

(1) S mode

When the accel dial is at setting 10 and auto decel mode is cancelled and S mode is selected.

Engine rpm	Effect
1800 ± 50	Same power as non mode type machine.

- ※ When the accel dial is located below 9 the engine speed decreases about 50~100rpm per dial set.

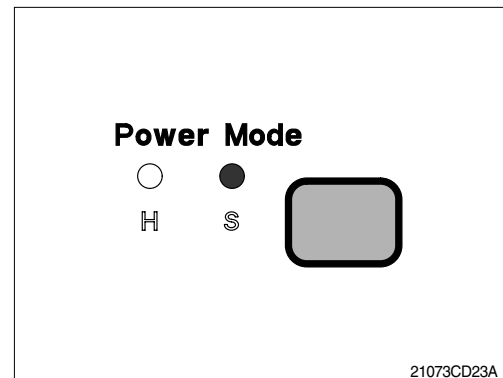

21073CD23A

(2) H mode

When the accel dial is at setting 10 and auto decel mode is cancelled and H mode is selected.

Engine rpm	Effect
1900 ± 50	Approximately 110% of power and speed available than non mode type machine or S mode.

- ※ When the accel dial is located below 9 the engine speed decreases about 50~100rpm per dial set.

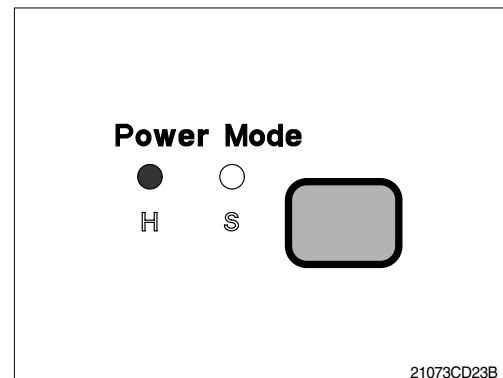

21073CD23B

(3) M mode

When the accel dial is at setting 10 and auto decel mode is cancelled and H mode is selected.

Engine rpm	Effect
2000 ± 50	Approximately 130% of power and speed available than non mode type machine or S mode.

※ When the accel dial is located below 9 the engine speed decreases about 50~100rpm per dial set.

