

5. OPERATION OF WORKING DEVICE

※ **Confirm the operation of control lever and working device.**

- 1) Left control lever controls arm and swing.
- 2) Right control lever controls boom and bucket.
- 3) When you release the control lever, control lever returns to neutral position automatically.

※ **When operating swing, consider the swing distance by inertia.**

※ **Refer to the switching method at page 3-15, when installed dozer or outrigger.**

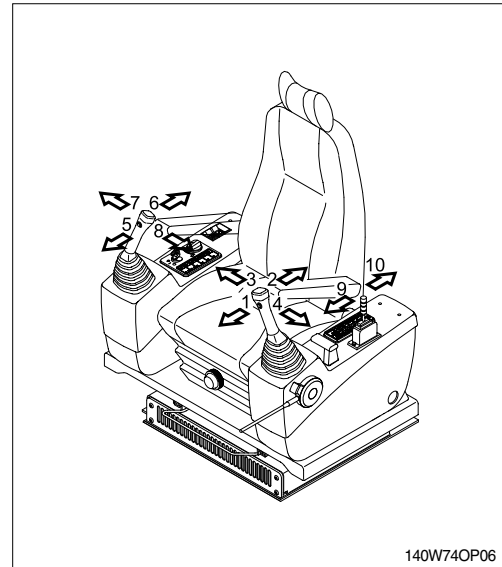

※ **Left control lever**

- 1 Arm roll-out
- 2 Arm roll-in
- 3 Swing right
- 4 Swing left

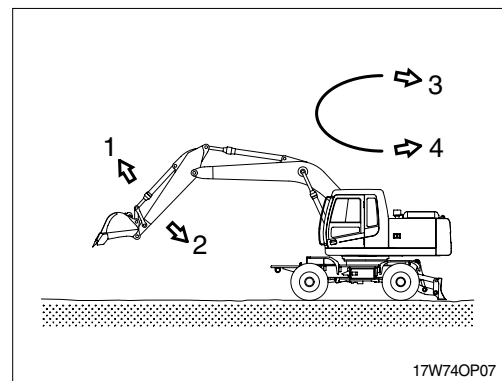

※ **Right control lever**

- 5 Boom lower
- 6 Boom raise
- 7 Bucket roll-out
- 8 Bucket roll-in

※ **Dozer and outrigger lever**

- 9 Dozer blade and outrigger up
- 10 Dozer blade and outrigger down

