

5. AIR CONDITIONER AND HEATER

Air conditioner and heater are equipped for pleasant operation against outside temperature and defrost on window glass.

- Location of air flow ducts

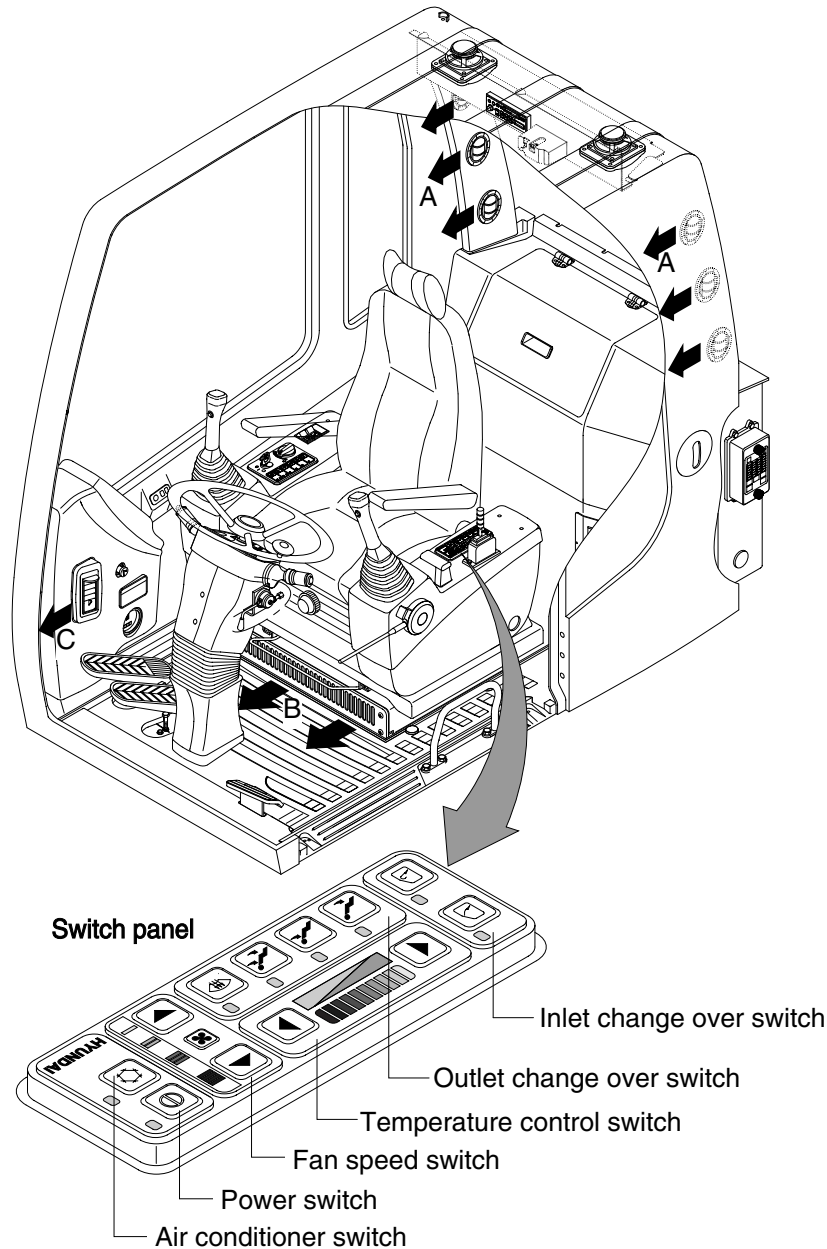

20W73CD42

1) POWER SWITCH

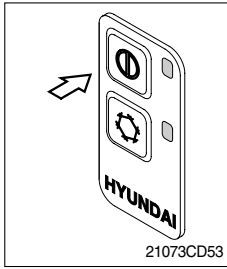

(1) This switch makes the system and the LED simultaneously ON or OFF.

(2) Default setting values

Function	Air conditioner	Fan speed	Temperature	Outlet	Inlet
Value	OFF	1	Max cool	Face	Recirculation

2) AIR CONDITIONER SWITCH(Compressor switch)

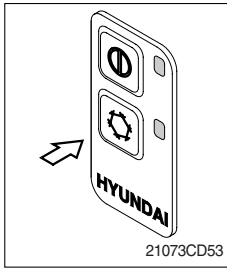

(1) Operating this switch turns the compressor and the LED simultaneously ON or OFF.

(2) In accordance with the evaporator temperature, compressor turns ON or OFF automatically without changing LED state.

※ **Air conditioner operates to remove vapor and drains water through a drain hose. Water can be sprayed into the cab in case that the vacuum valve of drain hose has a problem.**

In this case, exchange the vacuum valve.

3) FAN SPEED SWITCH

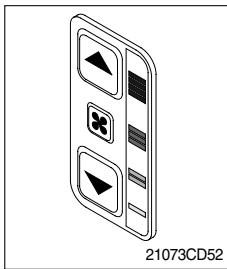

(1) It is possible to control the fan to four steps.

(2) The first step or the fourth step gives 5 times beeps.

4) TEMPERATURE CONTROL SWITCH

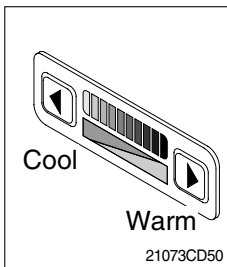

(1) There are 9 steps to control temperature from max cool to max warm controlled up and down by 1 step.

(2) Max cool and max warm arouse 5 times beeps.

(3) For the max warm or the max cool it's better to be configured as following table.

Temperature	Air conditioner	Fan speed	Outlet	Inlet
Max cool	ON	4	Face	Recirculation
Max warm	OFF	3	Foot	Fresh

5) OUTLET CHANGE OVER SWITCH

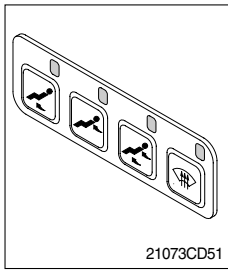

(1) There are four steps of air flow.

Switch position		Mode			
Outlet	A				
	B				
	C				

(2) When defroster switch operating, INLET switch turns to FRESH mode and air conditioner switch turns ON.

(3) In case of heating range(5~Max warm), air conditioner won't turn ON.

6) INLET CHANGE OVER SWITCH

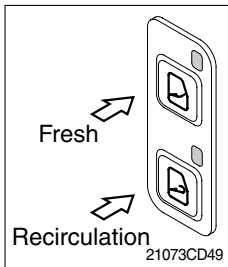

(1) It is possible to change the air-inlet method.

① Fresh

Inhaling air from the outside to pressurize cab inside.

※ **Check out the fresh air filter periodically to keep a good efficiency.**

② Recirculation

It recycles the heated or cooled air to increase the energy efficiency.

※ **Change air occasionally when using recirculation for a long time.**

※ **Check out the recirculation filter periodically to keep a good efficiency.**

(2) Recirculation function operates when the system is OFF but it can be changed whenever needed.

■ **AUTO AIR CONDITIONER AND HEATER(OPTION)**

Auto air conditioner and heater system automatically keeps the optimum condition in accordance with operator's temperature configuration sensing ambient and cabin inside temperature.

- Location of air flow ducts

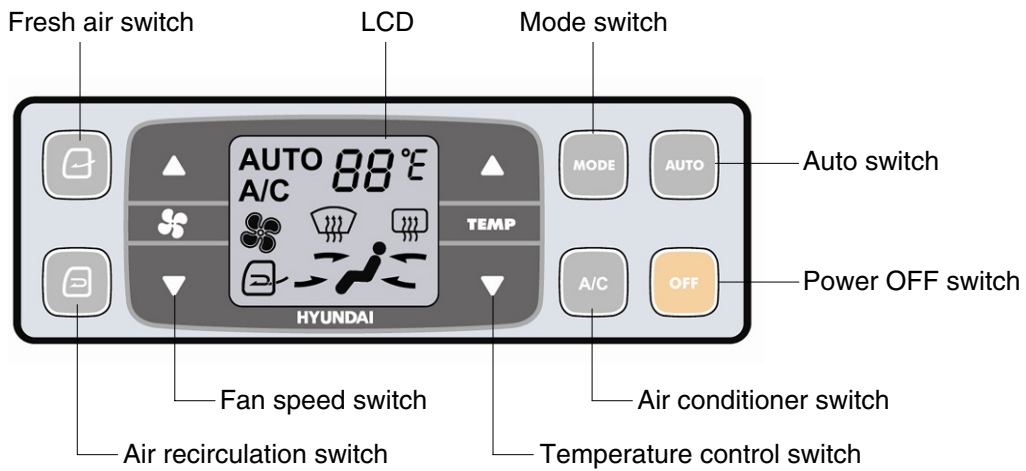
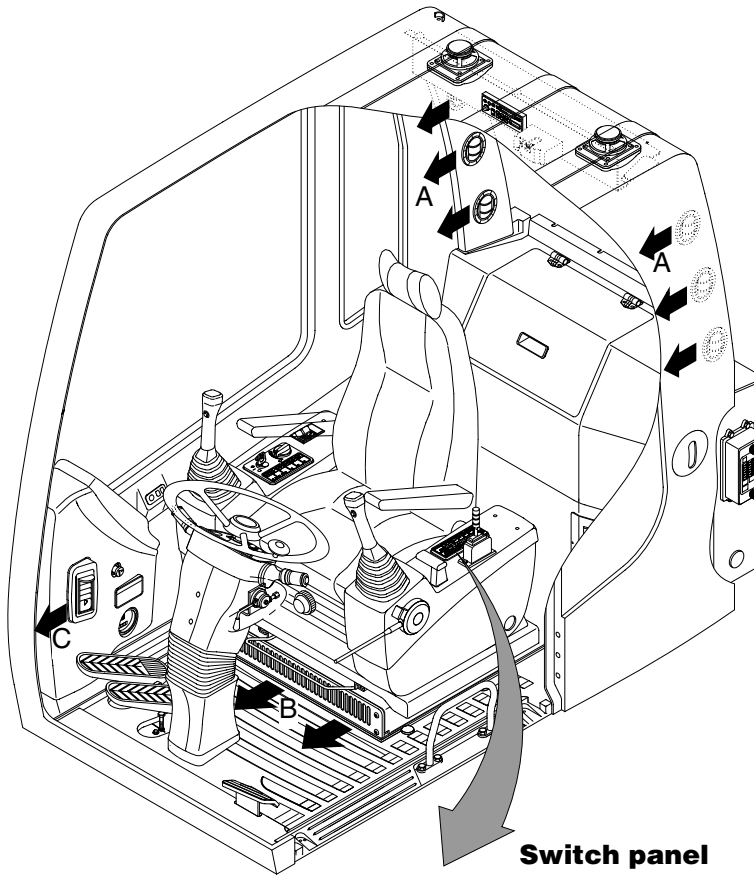

17W73CD49

1) POWER OFF SWITCH

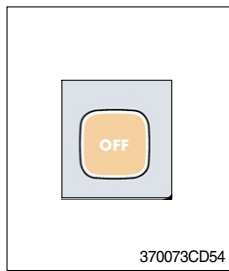

- (1) This switch makes the system and the LED OFF.
Just before the power OFF, setted values are stored.

(2) Default setting values

Function	Air conditioner	In/outlet	LCD	Temperature	Mode
Value	OFF	Inlet	OFF	Previous sw OFF	Previous sw OFF

2) AUTO SWITCH

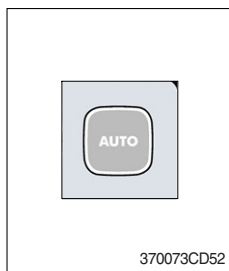

- (1) Turn the starting switch to ON position, LCD lights ON.
Auto air conditioner and heater system automatically keeps the optimum condition in accordance with operator's temperature configuration sensing ambient and cabin inside temperature.
- (2) This switch can restart system after system OFF.

3) AIR CONDITIONER SWITCH(Compressor switch)

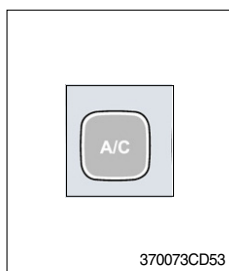

- (1) This switch turns the compressor and the LCD ON.
- (2) In accordance with the temperature sensed by duct(evaporator) sensor, compressor turns ON or OFF automatically.
- ※ **Air conditioner operates to remove vapor and drains water through a drain hose. Water can be sprayed into the cab in case that the drain cock at the ending point of drain hose has a problem.**
In this case, exchange the drain cock.

4) FAN SPEED SWITCH

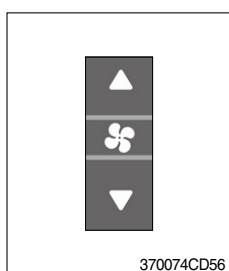

- (1) Fan speed is controlled automatically by setted temperature.
- (2) This switch controls fan speed manually.
- There are 8 up/down steps to control fan speed.
 - The maximum step or the minimum step beeps 5 times.
- (3) This switch makes the system ON.
- ▲ : First step(AUTO)
 - ▼ : First step(Manually)

5) TEMPERATURE CONTROL SWITCH

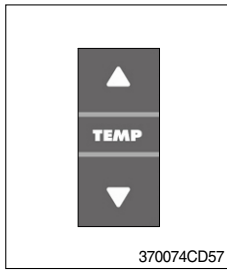

- (1) Setting temperature indication(17~32°C, Scale : 1°C)
- (2) Max cool and max warm beeps 5 times.
- (3) The max cool or the max warm position operates as following table.

Temperature	Compressor	Fan speed	In/Outlet	Mode
Max cool	ON	Max(Hi)	Recirculation	Vent
Max warm	OFF	Max(Hi)	Fresh	Foot

6) MODE SWITCH

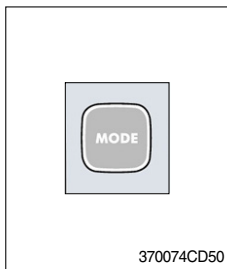

- (1) Operating this switch, it beeps and displays symbol of each mode in order.(Vent → B/L → Foot → Def → Vent)

Mode switch		Vent	B/L	Foot	Defroster
Outlet	A	●	●		
	B		●	●	●
	C				●

- (2) When defroster switch operating, FRESH AIR/AIR RECIRCULATION switch turns to FRESH AIR mode and air conditioner switch turns ON.
- (3) When this switch ON, the system operates with previous configuration.

7) FRESH AIR/AIR RECIRCULATION SWITCH

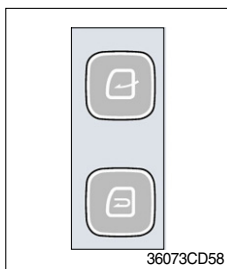

- (1) It is possible to change the air-inlet method.
 - ① **Fresh air** ()
Inhaling air from the outside.
※ **Check out the fresh air filter periodically to keep a good efficiency.**
 - ② **Air recirculation** ()
It recycles the heated or cooled air to increase the energy efficiency.
※ **Change air occasionally when using recirculation for a long time.**
※ **Check out the recirculation filter periodically to keep a good efficiency.**

8) SELF DIAGNOSIS FUNCTION

(1) Procedure

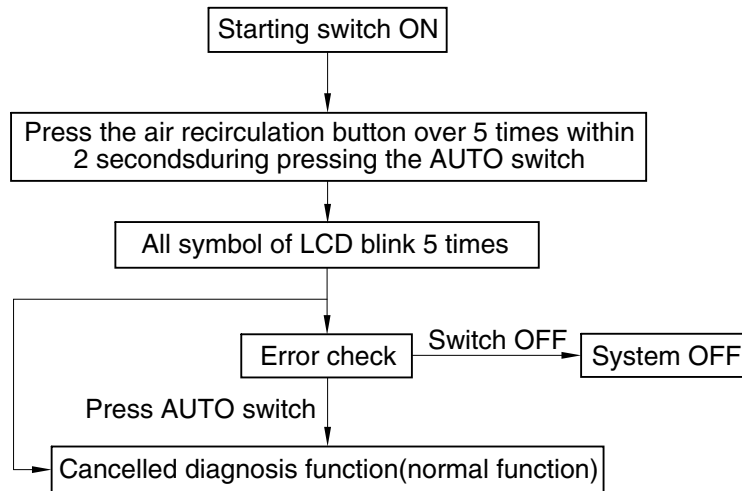

3607A3CD69

(2) Error check

- The corresponding error code flickers on the setup temperature display panel, the other symbol will turn OFF.
- Error code flickers every 0.5 second.
- If error code is more than two, each code flickers 2 times in sequence.
- Error code

Error code	Description	Error code	Description
11	Ambient sensor	14	Duct(evaporator) sensor
12	Cabin inside sensor	15	Temp actuator
13	Coolant temp sensor	16	Mode actuator

(3) Fail safe function

Error description	Fail safe function
Ambient sensor(11)	25°C alternate value control
Cabin inside sensor(12)	20°C alternate value control
Coolant temp sensor(13)	More than 10 minutes after engine start up, the alternate value is ON
Duct(evaporator) sensor(14)	1°C alternate value control
Temp actuator(15)	If opening amount is 0%, the alternate value is 0%
	If not, the alternate value is 100%
Mode actuator(16)	The alternate value is Vent