

SPECIFICATIONS

1. MAJOR COMPONENTS

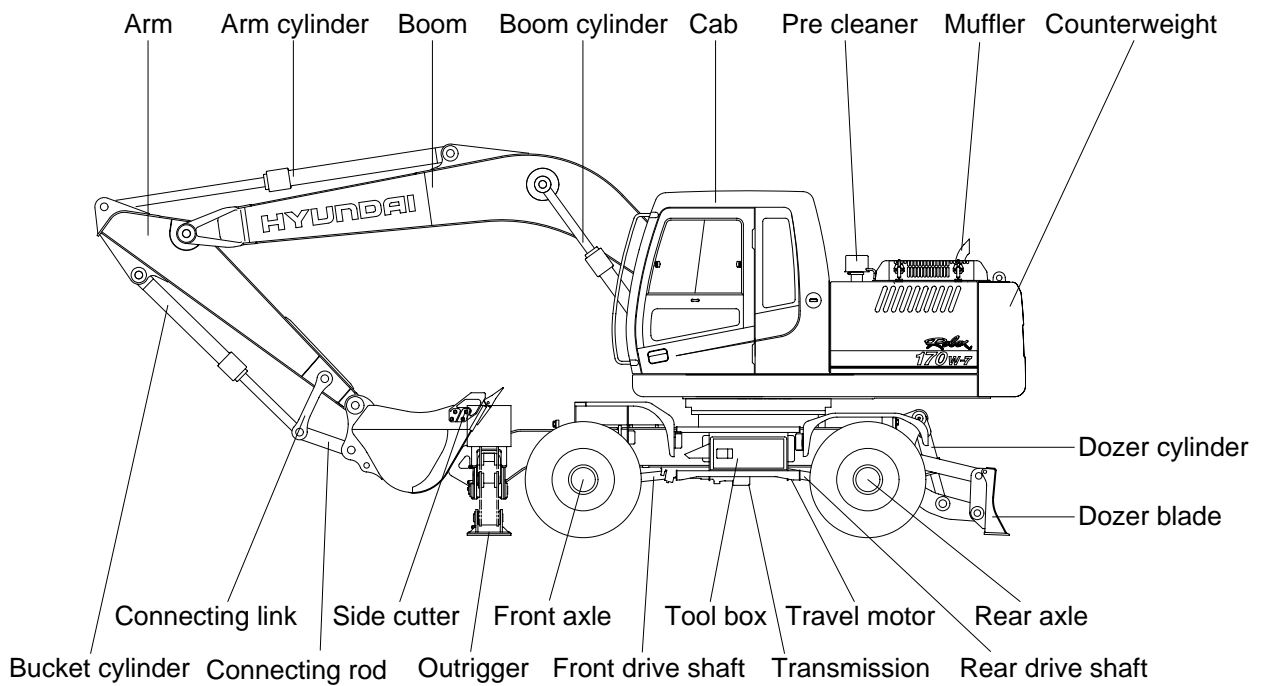
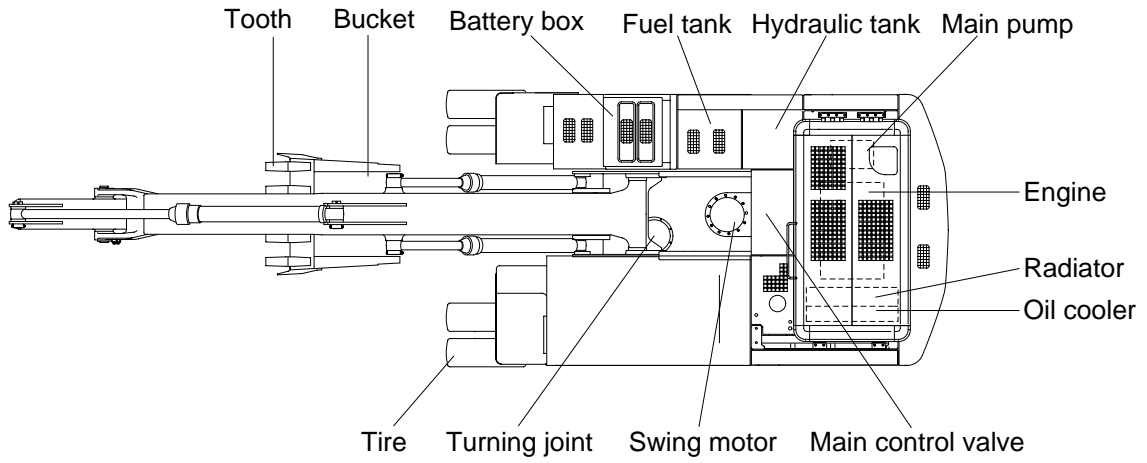

17W72SP01