

SPECIFICATIONS

1. MAJOR COMPONENT

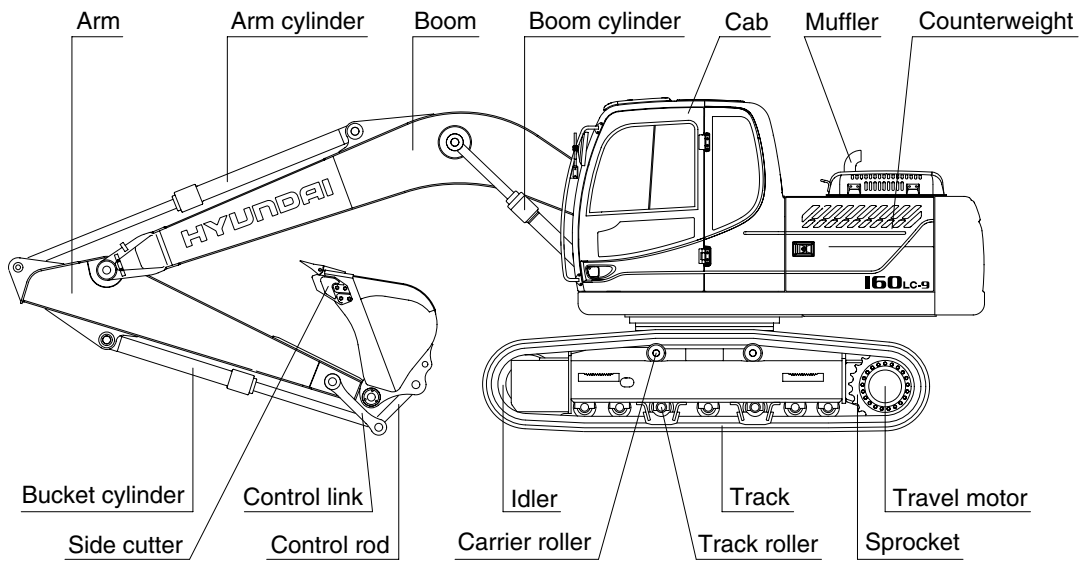
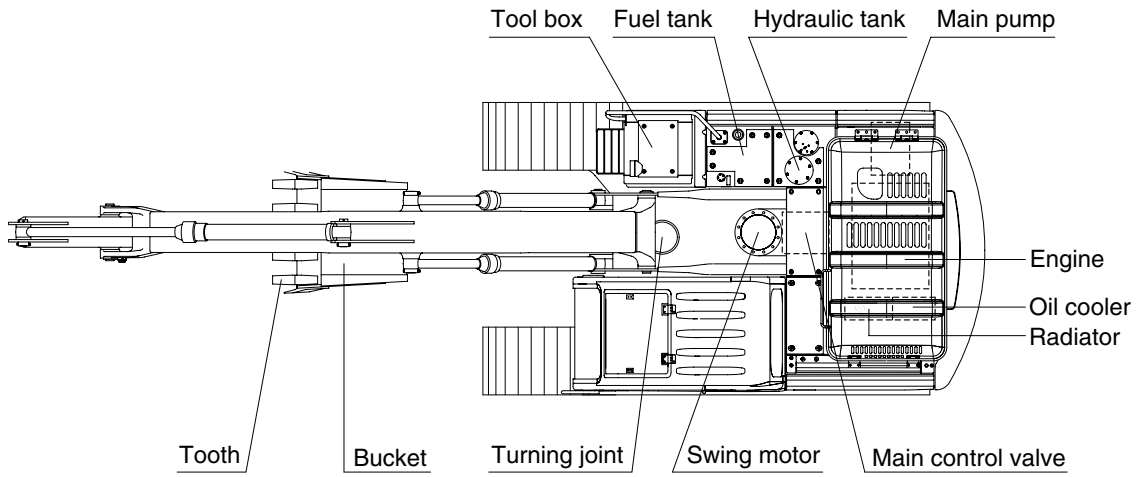

16092SP01