

## FOREWORD

This manual contains a number of instructions and safety recommendations regarding driving, handling, lubrication, maintenance, inspection and adjustment of the excavator.

The manual is to promote safety maintenance and enhance machine performance.

Keep this manual handy and have all personnel read it periodically.

If you sell the machine, be sure to give this manual to the new owners.

This machine complies with EC directive "2006/42/EC".

1. **Read** and **understand** this manual before operating the machine.

This operator's manual may contain attachments and optional equipment that are not available in your area. Please consult your local Hyundai distributor for those items you require.

Improper operation and maintenance of this machine can be hazardous and could result in serious injury or death.

Some actions involved in operation and maintenance of the machine can cause a serious accident, if they are not done in a manner described in this manual.

The procedures and precautions given in this manual apply only to intended uses of the machine.

If you use your machine for any unintended uses that are not specifically prohibited, you must be sure that it is safe for you and others. In no event should you or others engage in prohibited uses of actions as described in this manual.

2. **Inspect** the jobsite and **follow** the safety recommendations in the **safety hints** section before operating the machine.

3. Use **genuine Hyundai spare parts** for the replacement of parts.

We expressly point out that Hyundai will not accept any responsibility for defects resulting from non-genuine parts or non workmanlike repair.

In such cases Hyundai cannot assume liability for any damage.

Continuing improvements in the design of this machine can lead to changes in detail which may not be reflected in this manual. Consult Hyundai or your Hyundai distributor for the latest available information for your machine or for questions regarding information in this manual.

## BEFORE SERVICING THIS MACHINE

It is the responsibility of the owner and all service and maintenance personnel to avoid accidents and serious injury by keeping this machine properly maintained.

It also is the responsibility of the owner and all service and maintenance personnel to avoid accidents and serious injury while servicing the machine.

No one should service or attempt to repair this machine without proper training and supervision.

All service and maintenance personnel should be thoroughly familiar with the procedures and precautions contained in this manual.

All personnel also must be aware of any federal, state, provincial or local laws or regulations covering the use and service of construction equipment.

The procedures in this manual do not supersede any requirements imposed by federal, state, provincial or local laws.

Hyundai can not anticipate every possible circumstance or environment in which this machine may be used and serviced.

All personnel must remain alert to potential hazards.

Work within your level of training and skill.

Ask your supervisor if you are uncertain about a particular task. Do not try to do too much too fast.

Use your common sense.

## EC REGULATION APPROVED

- Noise level (EN474-1 : 2006 and 2000/14/EC) are as followings.

LWA : 101dB(EU only)

LPA : 70dB

- The value of vibrations transmitted by the operator's seat are lower than standard value of (EN474-1 : 2006 and 2002/44/EC)

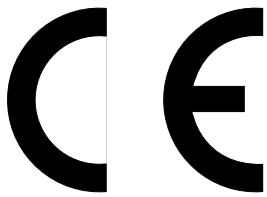

**TABLE TO ENTER SERIAL NO. AND DISTRIBUTOR**

Machine Serial No.	
Engine Serial No.	
Manufacturing year	
Manufacturer Address	Hyundai Heavy Industries co., Ltd. 1 Chonha-Dong, Dong-Ku Ulsan The Republic of Korea.
Distributor for U.S.A Address	Hyundai Heavy Industries U.S.A, Inc 955 Estes Avenue EIK Grove village IL, 60001 U.S.A
Distributor for Europe Address	Hyundai Heavy Industries Europe N. V. Vossendal 11 2240 Geel Belgium
Dealer Address	

# SAFETY LABELS

## 1. LOCATION

Always keep these labels clean. If they are lost or damaged, attach them again or replace them with a new label.

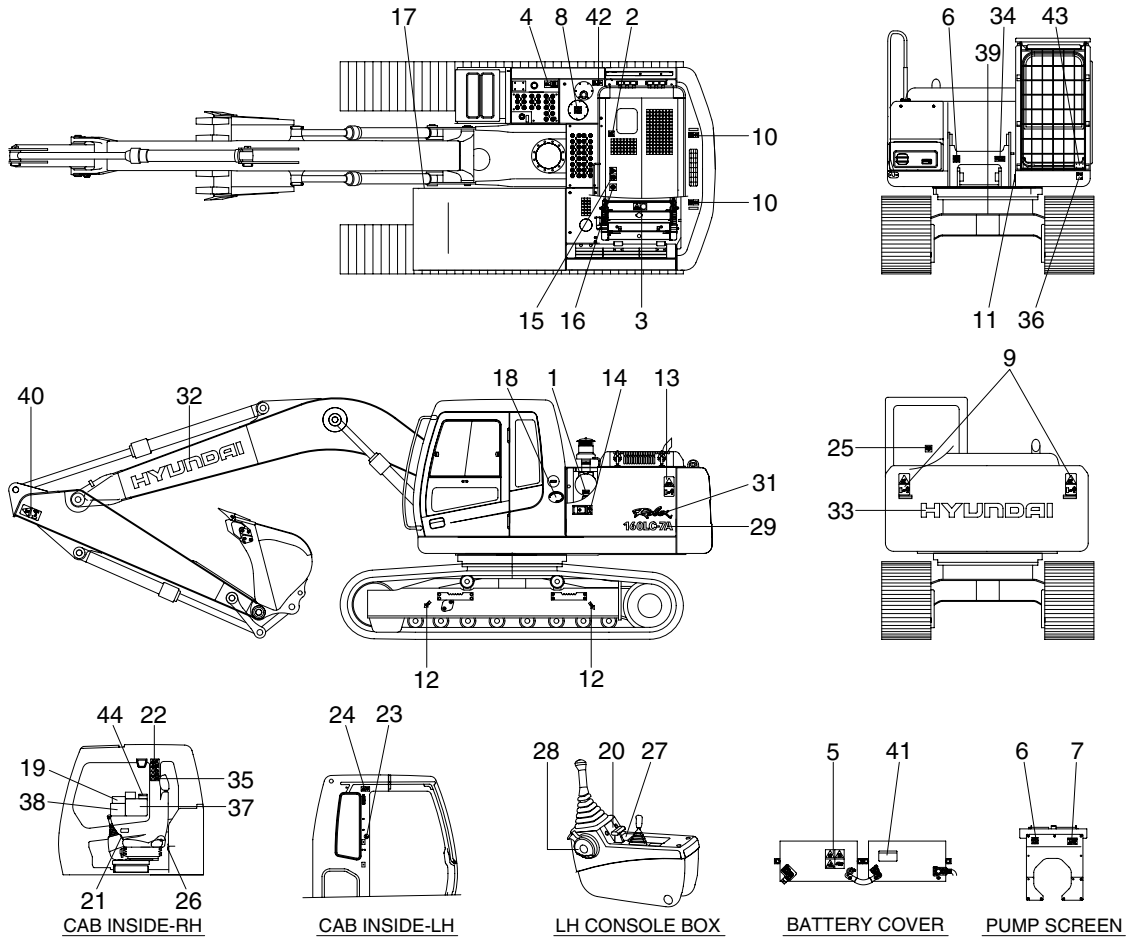

- |    |                      |    |                                   |    |                       |
|----|----------------------|----|-----------------------------------|----|-----------------------|
| 1  | Air cleaner filter   | 16 | No step engine hood               | 32 | Trade mark(Boom)      |
| 2  | Turbocharger cover   | 17 | Transporting                      | 33 | Trade mark(CWT)       |
| 3  | Radiator cap         | 18 | Low emission engine               | 34 | Reduction gear grease |
| 4  | Fueling              | 19 | Control ideogram                  | 35 | Locking-clamp         |
| 5  | Battery accident     | 20 | Control ideogram(LH)              | 36 | Noise level LWA       |
| 6  | High pressure hose   | 21 | Control ideogram(RH)              | 37 | Service instruction   |
| 7  | Hydraulic oil level  | 22 | Ref operator manual-Cab.RH pillar | 38 | Lifting chart         |
| 8  | Hydraulic oil lub    | 23 | Hammer                            | 39 | Tie                   |
| 9  | Keep clear-rear      | 24 | Safety front window               | 40 | Keep clear-Boom/arm   |
| 10 | Lifting eye          | 25 | Alternate exit                    | 41 | ECU connector         |
| 11 | Name plate           | 26 | Air conditioner filter            | 42 | Falling               |
| 12 | Slinging ideogram    | 27 | Console box tilting               | 43 | FOPS FOG plate        |
| 13 | Keep clear-side      | 28 | Safety lever                      | 44 | Turbocharger          |
| 14 | Stay fix             | 29 | Model name                        |    |                       |
| 15 | Shearing-engine hood | 31 | Logo(ROBEX)                       |    |                       |

1607A0SL01A

## 2. DESCRIPTION

There are several specific warning labels on this machine please become familiarized with all warning labels.

Replace any safety label that is damaged, or missing.

### 1) AIR CLEANER FILTER(Item 1)

This warning label is positioned on the air cleaner cover.

- **Periodic and proper inspection, cleaning and change of elements prolong engine life time and maintain the good performance of engine.**

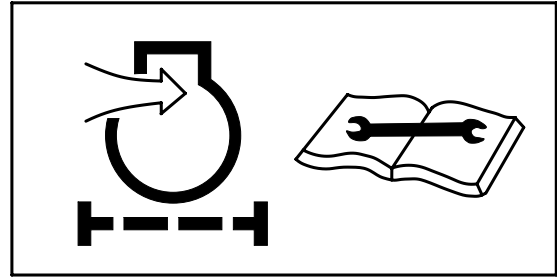

21070FW01

### 2) TURBOCHARGER COVER(Item 2)

This warning label is positioned on the turbo charger cover.

- **Do not touch turbo charger or it may cause severe burn.**

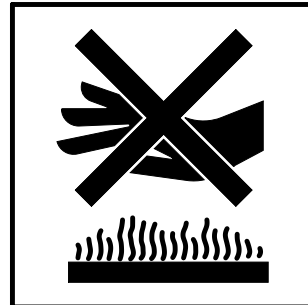

21070FW02

### 3) RADIATOR CAP(Item 3)

This warning label is positioned on the radiator.

- **Never open the filler cap while engine running or at high coolant temperature.**



14070FW03

### 4) FUELING(Item 4)

This warning label is positioned on the right side of fuel filler neck.

- **Stop the engine when refueling. All lights or flames shall be kept at a safe distance while refueling.**

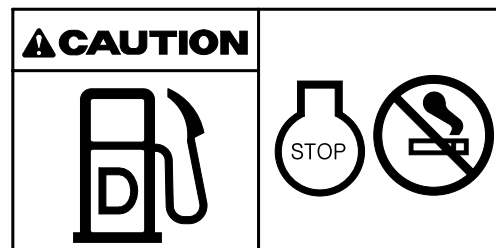

21070FW04

**5) BATTERY ACCIDENT (Item 5)**

This warning label is positioned on the battery cover.

- ⚠ **Electrolyte containing sulfuric acid cause severe burns. Avoid being in contact with skin, eyes or clothes. In the event of accident flush with sufficient water, call a physician immediately.**
- ⓘ **Maintain the electrolyte at the recommended level. Add distilled water to the battery only when starting up, never when shutting down.**  
With electrolyte at proper level, less space may cause the gases to be accumulated in the battery.
- ⚠ **Extinguish all smoking materials and open flames before checking the battery.**
- ⚠ **Do not use matches, lighters or torches as a light source near the battery for the probable presence of explosive gas.**
- ⚠ **Do not allow unauthorized personnel to change the battery or to use booster cables.**
- ⚠ **For safety from electric shock, do not battery terminal with a wet hand.**

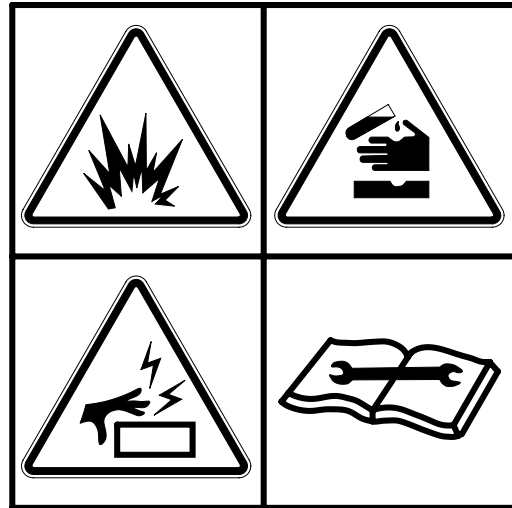

36070FW05

**6) HIGH PRESSURE HOSE (Item 6)**

This warning label is positioned on the screen plate.

- ⚠ **Escaping fluid under pressure can penetrate the skin causing serious injury.**
- ⓘ **Study the service manual before service job.**



14070FW29

### 7) HYDRAULIC OIL LEVEL(Item 7)

This warning label is positioned on the left side of hydraulic oil level.

- ▲ Place the bucket on the ground whenever servicing the hydraulic system.
- ; Check oil level on the level gauge.
- ; Refill the recommended hydraulic oil up to specified level if necessary.

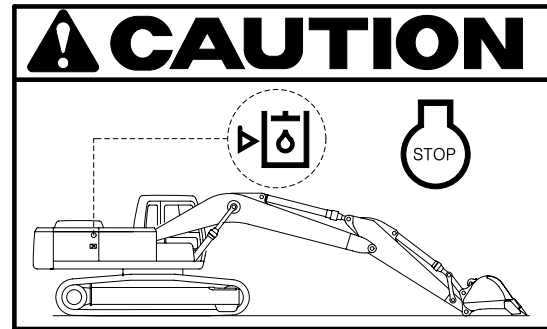

21070FW07

### 8) HYDRAULIC OIL LUBRICATION(Item 8)

This warning label is positioned on the right side of air breather.

- ; Do not mix with different brand oils.
- ▲ Never open the filler cap while engine running or at high coolant temperature.
- ▲ Loosen the cap slowly and release internal pressure completely.



14070FW08

### 9) KEEP CLEAR(Item 9)

This warning label is positioned on the counterweight.

- ▲ To prevent serious personal injury or death keep clear of machine swing radius.
- ▲ Do not deface or remove this label from the machine.



21070FW28

### 10) LIFTING EYE(Item 10)

This warning label is positioned on the counterweight.

- ▲ Do not lift the machine by using lifting eyes on the counterweight or the lifting eyes may be subject to overload causing its breaking and possible personal injury.
- ; See page 5-8 for proper lifting method of the machine.

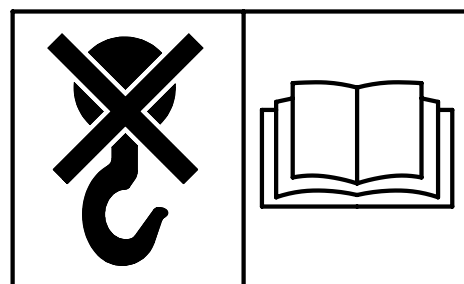

21070FW10

**11) SIDE KEEP CLEAR (Item 13)**

This warning label is positioned on the side of counterweight.

- ▲ To prevent serious personal injury or death keep clear of machine swing radius.
- ▲ Do not deface or remove this label from the machine.

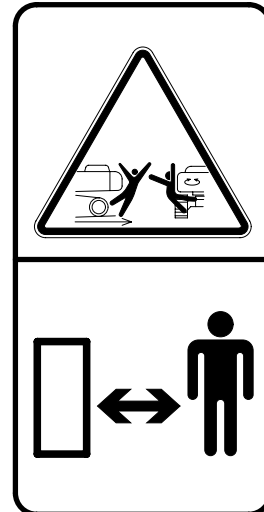

21070FW13

**12) STAY FIX (Item 14)**

This warning label is positioned on the side cover.

- ▲ Be sure to support the stay when the door needs to be opened.
- ▲ Be careful that the opened door may be closed by the external or natural force like strong wind.



21070FW14

**13) SHEARING-ENGINE HOOD (Item 15)**

This warning label is positioned on the engine hood.

- ▲ Don't open the engine hood during the engine's running.
- ▲ Don't touch exhaust pipe or it may cause severe burn.

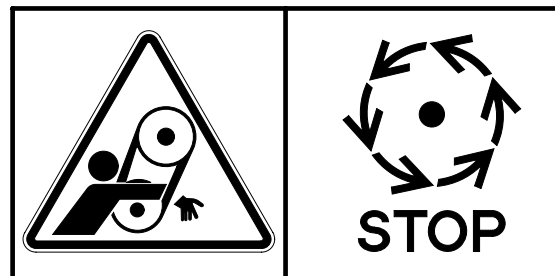

21070FW15

**14) NO STEP-ENGINE HOOD(Item 16)**

This warning label is positioned on the engine hood.

- △ Don't step on the engine hood.

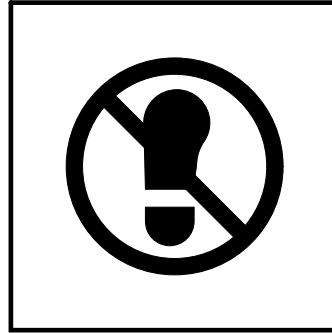

21070FW16

**15) TRANSPORTING(Item 17)**

This warning label is positioned right side of upper frame.

- ▲ Study the operator's manual before transporting the machine, if provided and tie down arm and track to the carrier with lashing wire.
- i See page 5-7 for details.

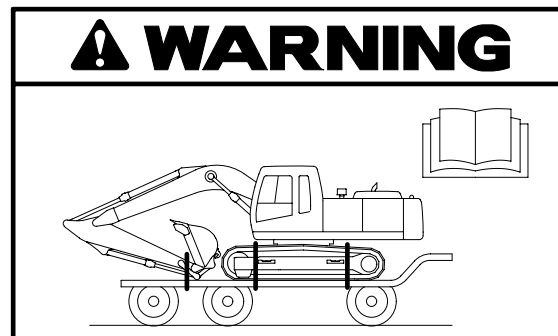

14070FW17

**16) CONTROL IDEOGRAM(Item 19)**

This warning label is positioned in right window of the cab.

- ▲ Check the machine control pattern for conformance to pattern on this label. If not, change label to match pattern before operating machine.
- ▲ Failure to do so could result in injury or death.

- i See page 4-12 for details.

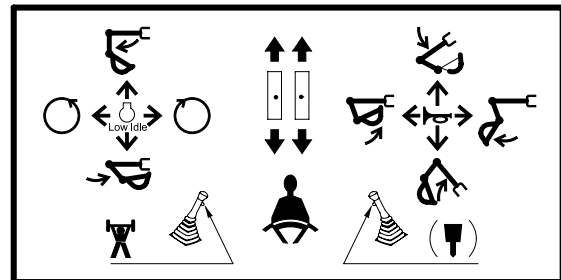

36070FW19

**17) CONTROL IDEOGRAM-LH(Item 20)**

This warning label is positioned on the LH console box.

- ▲ Check the machine control pattern for conformance to pattern on this label. If not, change label to match pattern before operating machine.
- ▲ Failure to do so could result in injury or death.

- i See page 4-12 for details.

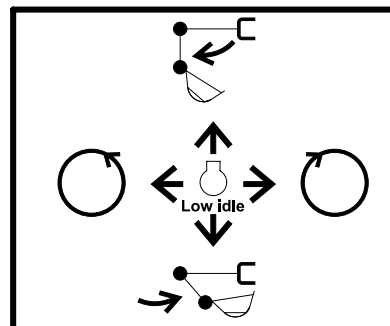

36070FW20

18) CONTROL IDEOGRAM-RH(Item 21)

This warning label is positioned on the RH console box.

- ▲ Check the machine control pattern for conformance to pattern on this label. If not, change label to match pattern before operating machine.

- ▲ Failure to do so could result in injury or death.

i See page 4-12 for details.

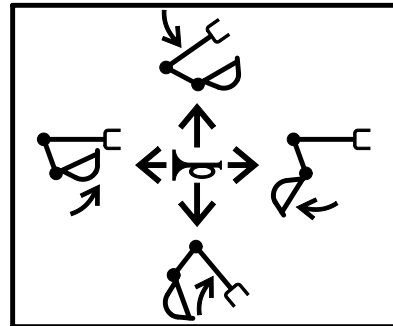

21070FW21

19) REF OPERATOR MANUAL(Item 22)

This warning label is positioned on the right side window of the cab.

- ▲ Study the operator's manual before starting and operating machine.

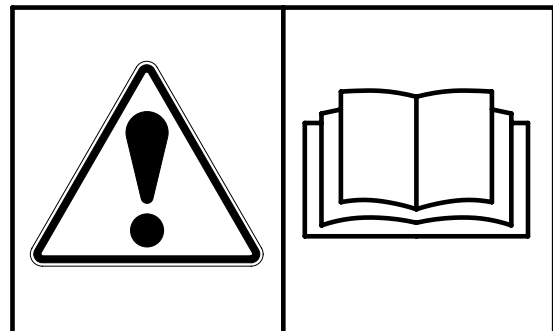

21070FW22

20) MAX HEIGHT(Item 22)

This warning label is positioned on the right side window of the cab.

- ▲ Serious injury or death can result from contact with electric lines.

An electric shock being received by merely coming into the vicinity of an electric lines, the minimum distance should be kept considering the supply voltage as page 1-7.

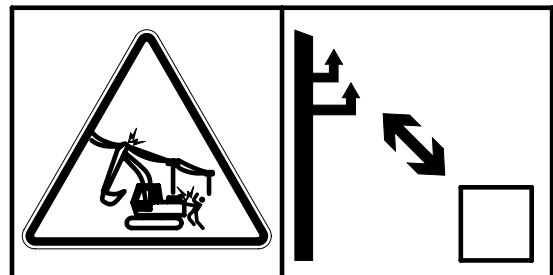

21070FW23

21) INTERFERENCE(Item 22)

This warning label is positioned on the right side window of cab.

- ▲ Be careful to operate machine equipped with quick clamp or extensions.

- ▲ Bucket may hit cab or boom, boom cylinders when it reached vicinity of them.

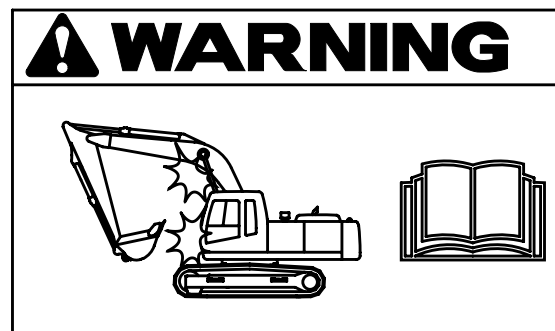

14070FW62

## 22) SAFETY FRONT WINDOW (Item 24)

This warning label is positioned on the inside of front window.

- ⚠ **Be careful that the front window may be promptly closed.**

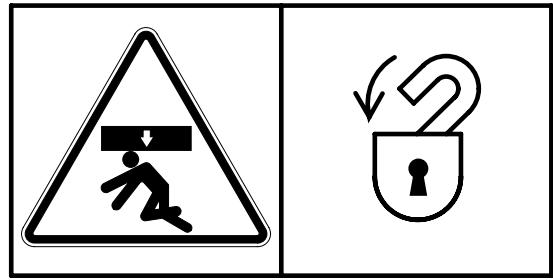

21070FW24

## 23) ALTERNATE EXIT (Item 25)

This warning label is positioned on the inside of rear window.

- ⓘ **The rear window serves us an alternate exit.**
- ⓘ **To remove rear window, pull the ring and push out the glass.**

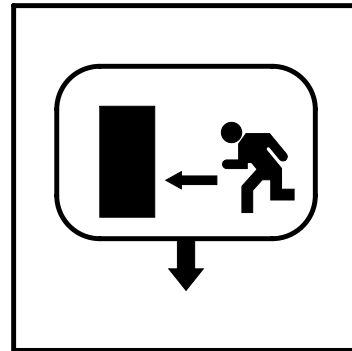

21070FW25

## 24) AIR CONDITIONER FILTER (Item 26)

This warning label is positioned on the air conditioner cover.

- ⓘ **Periodic and proper inspection, cleaning and change of filter prolong air conditioner life time and maintain good performance.**

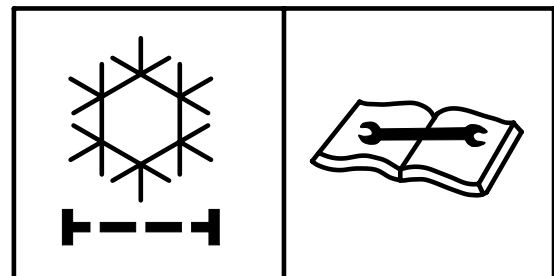

21070FW26

## 25) CONSOLE BOX TILTING (Item 27)

This warning label is positioned on the LH console box.

- ⓘ **Before you get off the machine be sure to tilt the LH console box.**

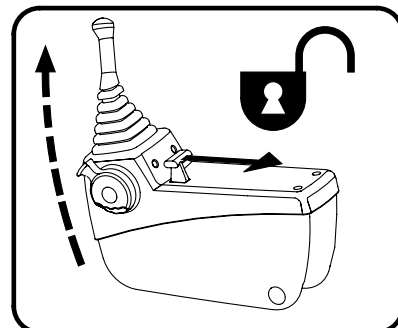

21070FW27

**26) SAFETY LEVER**(Item 28)

This warning label is positioned on the cover safety.

- ▲ Before you get off the machine be sure to place the safety lever **LOCKED** position.

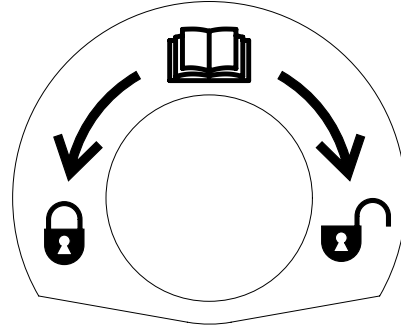

21070FW28

**27) REDUCTION GEAR GREASE**(Item 34)

This warning label is positioned in the front of upper frame.

- ▲ Grease is under high pressure. Grease coming out of the grease plug under pressure can penetrate the body causing injury or death.

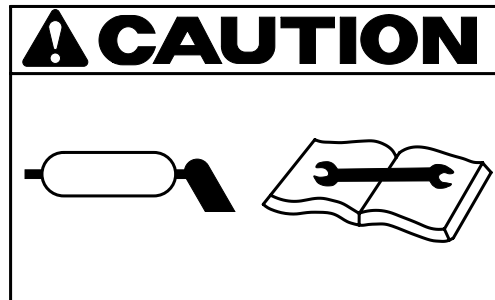

21070FW35

**28) CLAMP-LOCKING**(Item 35)

This warning label is positioned on the right side window of cab.

- ▲ Serious injury or death can result from dropping bucket.
- ▲ Operating the machine with quick clamp switch unlocked or without safety pin of moving hook can cause the bucket to drop off.

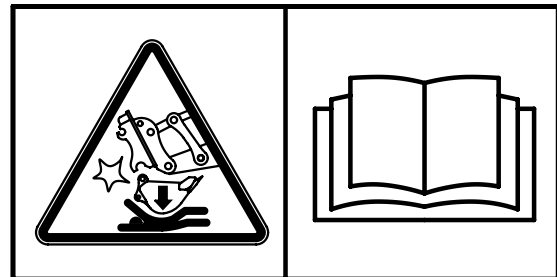

14070FW60

**29) TIE**(Item 39)

This warning label is positioned on the lower frame.

- ▲ See page 4-14 for detail.

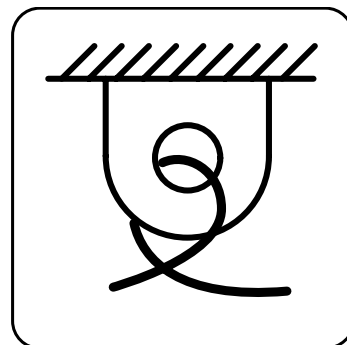

4507A0FW02

**30) KEEP CLEAR-BOOM/ARM(Item 40)**

This warning label is positioned on both side of the boom.

- ⚠ **Serious injury or death can result from falling of the attachment.**
- ⚠ **To prevent serious injury or death, keep clear the underneath of attachment.**



14070FW31

**31) ECU CONNECTOR(Item 41)**

This warning label is positioned on the battery cover.

- ⚠ **Before carrying out any electric welding on this machine.**  
Pull the connector out of all electric control units.
- ⚠ **Connector the ground lead of the welding equipment as close to the welding point as possible.**
- i See page 6-41 for detail.

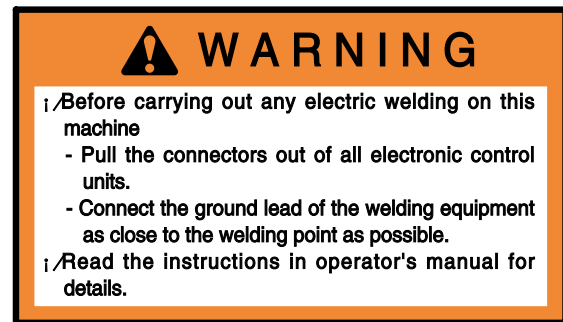

7807AFW20

**32) FALLING(Item 42)**

This warning label is positioned on the top of the hydraulic tank.

- ⚠ **Falling is one of the major cause of personal injury.**
- ⚠ **Be careful of slippery conditions on the platforms, steps and handrails when standing on the machine.**

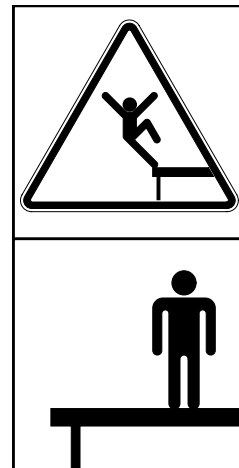

14070FW30

### 33) TURBOCHARGER(Item 44)

This warning label is positioned in right window of the cab.

- ▲ In order to prevent turbocharger failure, please allow more than 5 minutes' cool down period(no load low idle operation) before shutting the engine off.

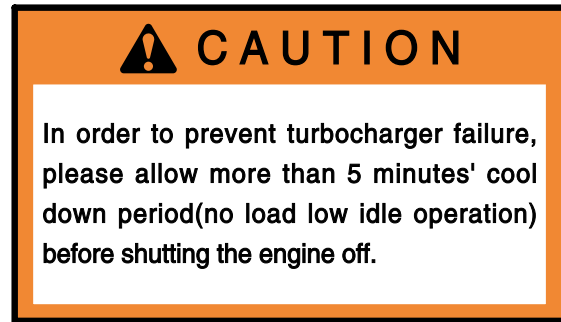

7807AFW20

# MACHINE DATA PLATE

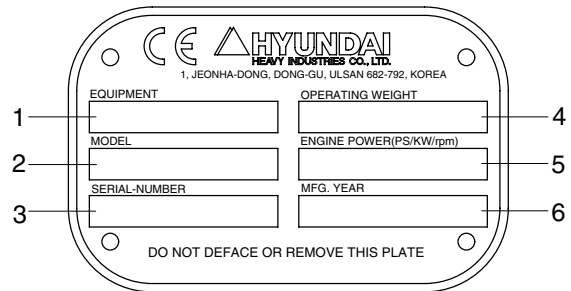
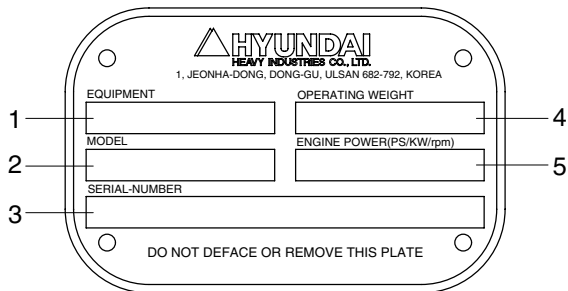

FOR EU ONLY

21090FW10

- |   |            |   |                  |   |                    |
|---|------------|---|------------------|---|--------------------|
| 1 | Equipment  | 3 | Serial number    | 5 | Engine power       |
| 2 | Model name | 4 | Operating weight | 6 | Manufacturing year |

※ The machine serial number assigned to this particular machine and should be used when requesting information or ordering service parts for this machine from your authorized HYUNDAI dealer. The machine serial number is also stamped on the frame.

## GUIDE

### 1. DIRECTION

The direction of this manual indicate forward, backward, right and left on the standard of operator when the travel motor is in the rear and machine is on the traveling direction.

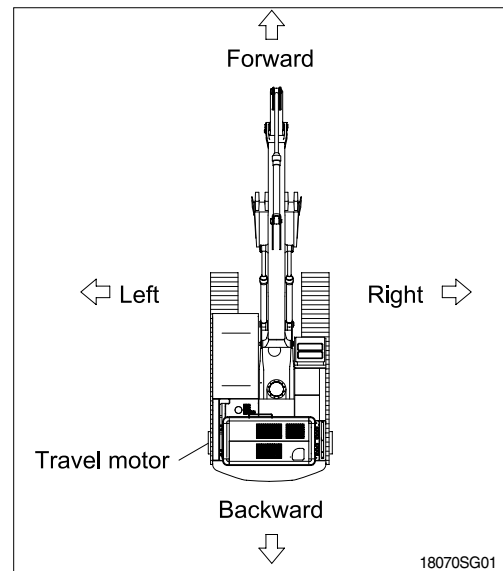

### 2. SERIAL NUMBER

Inform following when you order parts or the machine is out of order.

#### 1) MACHINE SERIAL NUMBER

The numbers are located below the right window of the operator's cab.

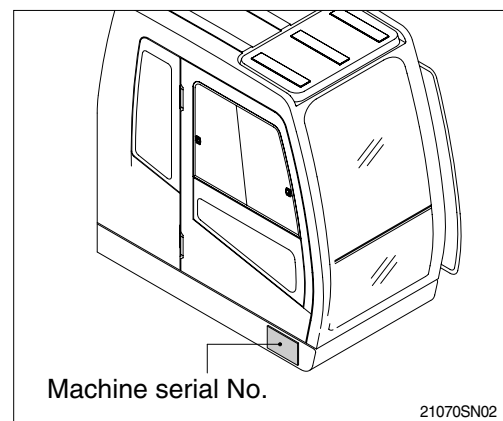

#### 2) ENGINE SERIAL NUMBER

The numbers are located on the engine name plate.

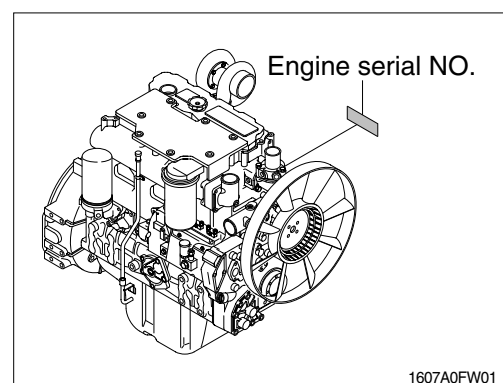

### 3. SYMBOLS

▲ Important safety hint.

△ It indicates matters which can cause the great loss on the machine or the surroundings.

※ It indicates the useful information for operator.